

# **200DX DUAL BEAM** *Fishfinder*

*Operations Manual*



# TABLE OF CONTENTS

INSTALLATION PREPARATION.....	2
Parts Supplied.....	2
Accessories.....	2
Installation Overview.....	2
Alternative Transducers and Mounting Methods.....	4
Transducer Exchange.....	5
INSTALLATION.....	6
Transom Installation.....	6
Inside the Hull Installation.....	10
Control Head Installation.....	12
Test the Installation.....	15
USING THE 200DX.....	16
How Sonar Works.....	16
Simulator Operation.....	17
What You See On Screen.....	18
Control Functions.....	21
Menu Functions.....	24
ADVANCED FEATURES.....	33
Using Diagnostic.....	33
SPECIFICATIONS.....	35
MAINTENANCE AND WARRANTY.....	36
Maintenance.....	36
Troubleshooting.....	37
Warranty.....	40
Service Policy.....	41
Customer Support.....	42

# INSTALLATION PREPARATION

## *PARTS SUPPLIED*

### ***PARTS SUPPLIED***

Before installing your new Humminbird fishfinder, please ensure the following parts are included in the box:

- Fishfinder
- Transducer with 20' (6m) of cable and mounting hardware kit
- Mounting system and mounting hardware kit
- 6' (2m) power cable
- Publications kit

If any of these items is missing, call our Customer Support Hotline.

### ***ACCESSORIES***

Humminbird offers a wide assortment of accessories that complement and expand the capability of your new fishfinder. These accessories are designed with the same high standards and are backed by the same one-year warranty. The Humminbird Accessory catalog included with your unit contains descriptions of the many accessories available and ordering information. All Humminbird accessories are available through your full-service Humminbird dealer or factory direct through our number listed in the Customer Support section.

### ***INSTALLATION OVERVIEW***

Your Humminbird fishfinder consists of two primary components to install: the control head and the transducer.

The control head contains the sonar transmit and receive circuitry, as well as the user controls and display. It should be installed in a location that provides access to the controls and visibility while in use. The control head mounts on a quick disconnect mounting system that swivels and tilts providing flexibility for viewing from almost anywhere on the boat.

The transducer converts electrical energy from the transmitter into mechanical pulses or sound waves. The transducer also receives the reflected sound waves and converts them back into electrical signals for display on the control head. It should be installed in contact with the surface of the water in an area that has smooth waterflow- usually on the transom of the boat. There are several mounting options for the transducer. Review the following section to determine the method that works for you and your boat.

# INSTALLATION PREPARATION

## INSTALLATION OVERVIEW

### *Determining How to Mount the Transducer*

Your Humminbird fishfinder includes a standard transducer. This transducer can be mounted on the transom of the boat or bonded to the inside of a fiberglass hull boat.

The transom installation, which is the most widely used, places the transducer on the outside of the boat hull. This technique produces the least signal loss, and provides a way to adjust the transducer after installation. The mounting hardware included is designed to protect both the boat and the transducer should the boat strike debris in the water or when trailering.

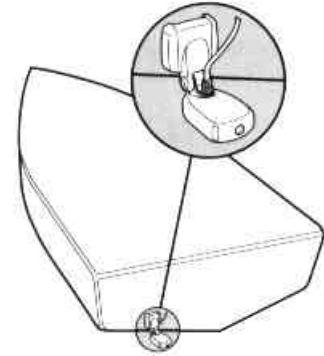

*Transom Mounted Transducer*

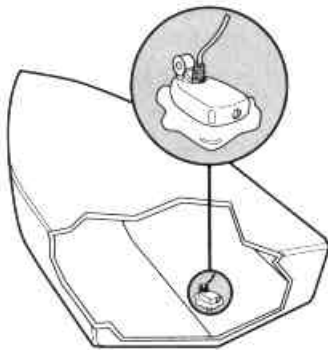

*Inside the Hull Mounted Transducer*

As an alternative to transom mounting, it is possible on many fiberglass-hulled boats to glue the transducer on the inside of the boat hull. Since fiberglass has similar sonar characteristics as water, the sonar signal can pass through the boat hull with minimal loss. The hull of the boat must be single layer construction (not double-hulled) Also, any air trapped in the lamination of the fiberglass would prevent the sonar signal from passing through.

Inside the hull installations require no holes be drilled into the boat and through experimentation, high-speed operation comparable to transom mounting can be achieved. Two-part slow cure epoxy (not included) is required to glue the transducer in place.

# INSTALLATION PREPARATION

## ALTERNATE MOUNTING METHODS

### **ALTERNATE TRANSDUCERS AND MOUNTING METHODS**

Your Humminbird fishfinder comes with everything necessary for installation and operation on most boats. However, there are several situations which may require a different type of transducer. Inboard boats, wood or metal hulls, and sail boats create unique transducer mounting needs. Alternate transducers and mounting methods are detailed below.

#### ***Portable Mounting***

The standard transducer can be adapted for portable installations with a portable mounting kit available from Humminbird. This accessory adapts your transducer to a suction cup mount for temporary installation on the boat hull or other surface.

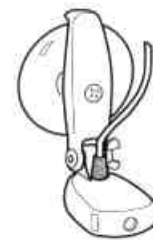

#### ***Trolling Motor Mounting***

The standard transducer can also be adapted to mount on most trolling motors using a different accessory kit. This accessory includes a bracket and hose clamp that allows mounting the transducer to the body of most trolling motors.



#### ***Thru-Hull Mounting***

Thru-hull transducers install through a hole drilled in the hull of the boat. Larger boats or boats with inboard motors create turbulence that make transom mounting ineffective. Also, hulls that are very thick or are double layered, or made from materials such as wood or metal, (which do not conduct sonar signals) make inside the hull mounting inadvisable.



Thru-hull mounting may require the use of a fairing block to level the transducer with the waterline. Also, since special tools and knowledge may be required to perform this type of installation, it is best to refer to a qualified marine technician.

# INSTALLATION PREPARATION

## *TRANSDUCER EXCHANGE*

### ***TRANSDUCER EXCHANGE***

Other transducers are available as replacements for the standard transducer. You may exchange your new and unassembled transducer for another type by returning it to the address listed in Customer Support. Some transducers may have additional cost. Refer to the Accessory catalog or call Customer Support for information.

### ***BEGINNING INSTALLATION***

Now that you have determined the transducer mounting method you can begin installation of your new Humminbird fishfinder. The installation guide included on the next few pages provides detailed step by step instructions for installation of the control head and transducer. For transom mount transducer installations you will need the mounting template included with your manual.

In addition to the parts included you need the following for installation and operation:

- A powered hand drill and various drill bits
- Philips and flat-head screwdrivers
- A ruler or measuring tape
- Pen or pencil
- 12 volt power source (your boat's battery)
- A 1-amp fuse
- A fuse holder (if you are wiring directly to the boat's battery)
- Silicone sealant (for sealing drilled holes)
- 2-part, slow-cure epoxy (for inside the hull transducer installations)

# INSTALLATION

## TRANSOM INSTALLATION

**Do not begin this transducer installation until you read the Installation Preparation in the Operation Guide. This chapter contains information critical to the correct installation of your transducer.**

**Due to the wide variety of boat hulls, only general instructions are presented in the installation guide. Each boat hull represents a unique set of requirements that should be evaluated prior to installation.**

### TRANSOM INSTALLATION

#### Step One - Determine Where to Mount the Transducer

Begin the transducer installation by determining where on the transom to install the transducer. Consider the following to find the best location:

- It is very important to locate the transducer in an area which is relatively free of turbulent water. As a boat moves through the water, turbulence is generated by the weight of the boat, and the thrust of the propeller(s). This turbulent water is normally confined to areas immediately aft of ribs, strakes or rows of rivets on the bottom of the boat, and in the immediate area of the propeller(s) (Figure 1). On outboard or inboard/outboard boats it is best to stay at least 15" (40cm) to the side of the propeller(s).
- If possible, viewing the transom of the boat while the boat is moving will provide the best means of locating turbulence free water. If maximum high-speed operation is a high priority, this is the recommended method. If this is not possible, select a location on the transom where the hull forward of this location is smooth, flat, and free of protrusions or ribs.
- The transducer when mounted should point straight down. The design of the transducer will accommodate a wide range of deadrises and remain ported straight down (Figure 2).
- On boats with stepped hulls, it may be possible to mount the transducer on the step. Never mount the transducer on the transom behind a step, as this area of the transom will not be in contact with the water at high speed (Figure 3).

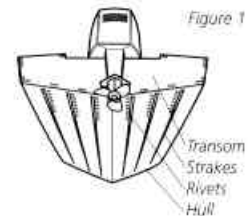

Transom Mounting Location

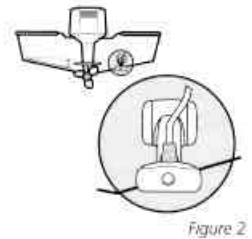

Figure 2

Stepped Hull

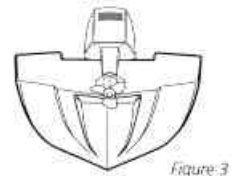

Figure 3

# INSTALLATION

## TRANSOM INSTALLATION

- If the propeller(s) is (are) forward of the transom, it may be impossible to find an area clear from turbulence, and a different mounting technique or transducer type should be considered.

### Step Two - Drill the Mounting Holes

1. Remove the mounting template from the front of the Operations Manual.
2. Hold the template on the transom of the boat in the location where the transducer will be installed (Figure 4). Align the template vertically, ensuring the lower edge of the transom meets with the bottom corner of the template.

Template alignment

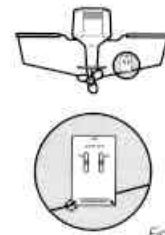

Figure 4

3. Using a pencil or punch, mark the two mounting holes shown on the template onto the transom. Do not mark or drill any other holes at this time.
4. Using a 5/32" (4mm) bit drill the two holes to a depth of approximately 1" (3cm). On fiberglass hulls, it is best to start with a smaller bit and use progressively larger drill bits to reduce the chance of chipping or flaking the outer coating.

Transducer Assembly

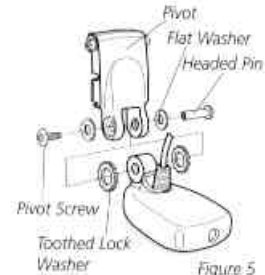

Figure 5

### Step Three - Assemble the Transducer

1. Attach the Pivot to the transducer body as shown in Figure 5, using the #8 – 3/8" (9mm) long allen headed pivot screw, the headed pin, the two flat washers, and the two toothed lock washers.

**Note: The toothed lock washers must be positioned between the transducer and the pivot ears. The flat washers must be positioned to the outside at the pivot ears.**

2. Using the Allen wrenches provided, loosely tighten the pivot screw (Figure 6). Do not completely tighten the assembly at this time, so the pivot angle can be adjusted later.
3. Insert the pivot/transducer assembly into the mounting bracket as shown in Figure 7. Do not snap the assembly closed.



Figure 6

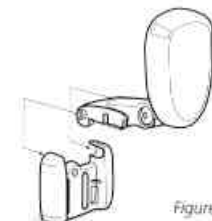

Figure 7



# INSTALLATION

## TRANSOM INSTALLATION

### **Step Four - Mount the Transducer to the Transom**

1. Apply silicone sealant to the mounting holes drilled into the transom.
2. Align the transducer assembly with the drilled holes in the transom (Figure 8).
3. Use either a flat head screwdriver, a 5/16" (8mm) hex driver, or a 5/16" (8mm) socket to mount the assembly. Using the two #10 – 1" (25mm) long slotted hex head screws, mount the transducer assembly to the transom as shown. Do not fully tighten the mounting screws in order to vertically adjust the transducer. Snap the pivot down into place.



Figure 8

### **Step Five - Adjust the Running Position of the Transducer**

The bracket allows height and tilt adjustment, the pivot screw allows angular adjustment. Initially, adjust the transducer as described in the following paragraphs. Further adjustment may be necessary to refine the installation after high speed testing.

1. First adjust the pivot angle of the transducer body so its length is parallel with the length of hull of the boat. Then pivot the transducer down so the rear is about 1/4 inch (6mm) lower than the front (Figure 9).
2. Fully tighten the two pivot screws using the Allen wrench. It may be necessary to retighten the pivot screws after the initial use as the plastics may still be seating to the lock washers.
3. Adjust the height of the assembly so the face of the transducer is 3/16" (4.5mm) beneath the lower edge of the transom (Figure 10). Mark the position of the mounting bracket on the transom with a pencil.
4. Force the pivot to the up position to gain access to the mounting screws. Assure the transducer location has not changed, then fully tighten the two mounting screws (Figure 11). Snap the pivot back down.

#### **Running Position Adjustment**



Figure 9

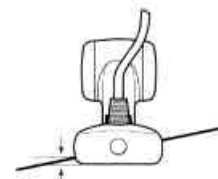

Figure 10

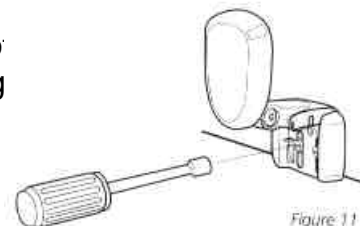

Figure 11

**Confirm the pivot angle has not changed.**

**Note: A third screw location is provided for the mounting bracket. Drill this hole and install the screw after final testing and adjustments have been completed.**

# INSTALLATION

## TRANSOM INSTALLATION

### **Step Six - Route the Cable**

There are several ways to route the transducer cable to the area where the control head will be installed. The most common procedure routes the cable through the transom into the boat.

Inside the boat there is often a channel or conduit used for other wiring that the cable can be routed along. Do not cut or shorten the transducer cable and try not to damage the cable insulation. Route the cable as far as practical from the VHF radio antenna cables or tachometer cable to reduce the possibility of interference.

If the cable is too short, extension cables are available to extend the transducer cable up to a total of 50' (15 m). Call Humminbird Customer Support for more information.

Follow these steps to route the cable through the transom:

1. Drill a 5/8" (16mm) hole above the water line. Route the cable through the hole.
2. Fill the hole with silicone sealant.
3. Place the escutcheon plate over the hole and attach with the two #8 x 5/8" (16mm) screws.
4. Secure the cable by attaching the cable camp to the transom using a #8 x 5/8" (16mm) screw.

**Note: The transducer will pivot up to 90 degrees in the bracket. Allow enough slack in the cable for this movement. It is best to route the cable to the side of the transducer so the cable will not be damaged by the transducer during movement.**

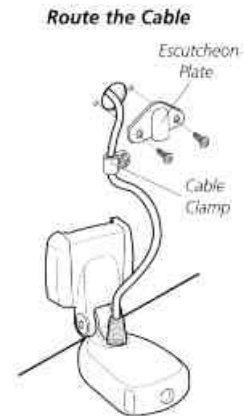

Figure 12

# INSTALLATION

## INSIDE THE HULL INSTALLATION

### INSIDE THE HULL INSTALLATION

Inside the hull installation requires the mount system and control head be installed and operational. See Installing the Control Head for instruction on installing the unit.

Inside the hull mounting generally produces good results in single thickness fiberglass-hulled boats. Humminbird cannot guarantee depth performance when transmitting and receiving through the hull of the boat since some signal loss occurs. The amount of loss depends on hull construction and thickness, and the installation.

This installation requires slow-cure two-part epoxy. Do not use silicone or any other soft adhesive to install the transducer, as this material reduces the sensitivity of the unit. Five minute epoxy has a tendency to cure before all the air bubbles can be purged.

#### Step One - Determine the Mounting Location

Begin the transducer installation by determining where inside the hull to install the transducer. Consider the following to find the best location:

- Observe the outside of the boat hull to find the areas that are mostly free from turbulent water. Avoid ribs, strakes, and other protrusions as these create turbulence (Figure 14).
- As a general rule, the faster the boat can travel the further aft and closer to the centerline of the hull the transducer has to be located to remain in contact with the water at high speeds.

#### Step Two - Test the Mounting Location

There is no opportunity for adjustment after the transducer glued in place. Therefore, it is best to perform a trial installation on inside the hull transducers first, and run the boat at high speeds to determine the best mounting area.

1. At the identified mounting location, lay the transducer body face down with the pointed end towards the bow.
2. Fill the hull with enough water to submerge the transducer body. Use a sand filled bag or other heavy object to hold the transducer in position.

The transducer cannot transmit through air. The water purges any air from between the transducer and the hull and fills any voids in the coarse fiberglass surface.

Transducer Mounted  
Inside the Hull

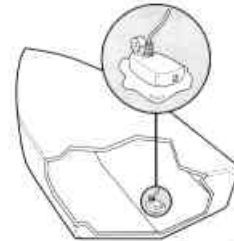

Figure 13

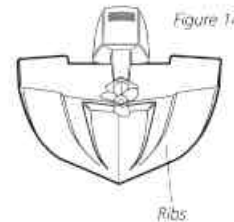

Figure 14

Preferred Mounting Area

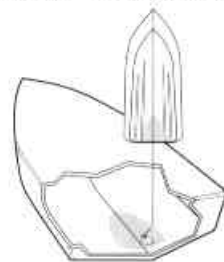

Figure 15

# INSTALLATION

## INSIDE THE HULL INSTALLATION

3. Power up the Control Head.
4. Run the boat at various speeds and water depths while observing the screen on the Control Head. If the unit functions well at low speeds but begins to skip or miss the bottom at higher speeds, the transducer needs to be moved. If depth performance is required, test the fishfinder in water at the desired depth. Test different locations in the hull until the optimum performance is achieved.

### **Step Three - Permanently Mount the Transducer**

1. Once the mounting location is determined, mark the position of the transducer.
2. Remove the water from inside the hull and thoroughly dry the mounting surface. If the surface is excessively rough, it may be necessary to sand the area to provide a smooth mounting surface.

Ensure the mounting area is clear and dry.

3. Mix an ample quantity of two-part slow-cure epoxy slowly and thoroughly. Avoid trapping air bubbles.
4. Coat the face of the transducer and the inside of the hull (Figure 16).
5. Press the transducer into place with a slight twisting motion to purge any trapped air from underneath, keeping the pointed end of the transducer body pointed forward (Figure 17).

Figure 16

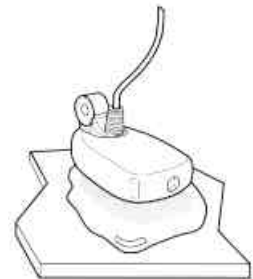
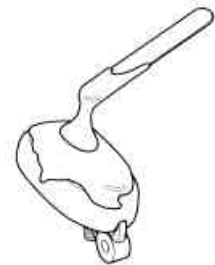

Figure 17

**Note: Proper operation requires the pointed end of the transducer body to face towards the bow.**

6. Weight the transducer so it does not move while the epoxy is curing.

When the epoxy cures, no water is necessary inside the hull. Neither water, spilled gasoline, or oil will affect the performance of the transducer.

# INSTALLATION

## CONTROL HEAD INSTALLATION

### CONTROL HEAD INSTALLATION

#### Step One - Determine Where to Mount

Begin the installation by determining where to mount the control head. Consider the following to determine best location:

- The cables for power, transducer and temp/speed accessories (if applicable) should be installed first and must reach the mounting location. Extension cables are available.
- There are two ways to route the cables to the unit: through a hole in the mounting surface underneath the mounting bracket or from a hole outside the mounting bracket. Routing the cables down under the mount provides maximum weather protection; however this is not always feasible if the area under the fishfinder is inaccessible. In this case, route the cables through a hole at another location and cover with the supplied hole cover.
- The mounting surface should be adequately supported to protect the fishfinder from excessive wave shock and vibration, and provide visibility while in operation.
- The mounting area should allow sufficient room for the unit to pivot and swivel freely, and for easy removal and installation (Figures 18-19).

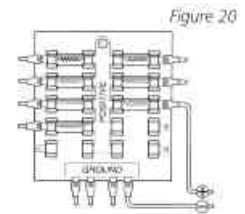
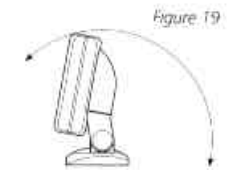
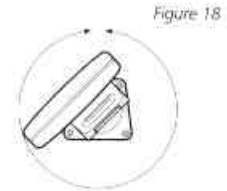

#### Step Two - Connect the Power Cable to the Boat

A 6' (2m) long power cable is included to supply power to the fishfinder. You may shorten or lengthen the cable using 18 gauge multi-stranded copper wire.

**CAUTION: Some boats have 24 or 36 volt electric systems. Be sure your unit is connected to a 12 VDC power supply.**

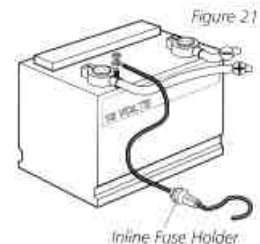

The Power can be connected to the boat's electrical system at two places: a fuse panel, usually located near the console, or directly to the battery.

If a fuse terminal is available, use crimp-on type electrical connectors (not included) that match the terminal on the fuse panel. Attach the black wire to ground, and the red wire to 12 VDC power (Figure 20). Be sure to use a one amp fuse in the connection. If you must wire the control head directly to a battery, be sure to install an inline fuse holder

# INSTALLATION

## CONTROL HEAD INSTALLATION

and one amp fuse (not included) for the protection of the unit (Figure 21). Humminbird is not responsible for over voltage or over current failures.

In order to minimize the potential for interference with other marine electronics a separate power source (such as a second battery) may be necessary.

### Step Three - Drill the Mounting Holes

1. Set the mounting bracket in place on the mounting surface. Mark the four mounting screw locations with a pencil or punch.
2. Set the mounting bracket aside, and drill the four mounting screw holes using a 9/64" (3.6mm) bit.

### Step Four - Run the Cables

1. If the cables must pass through a hole underneath the mounting surface, mark and drill a 1" (25mm) hole centered between the four mounting holes (Figure 22).

**Note: if the cables must pass through the mounting surface at a different location, drill the 1" (25mm) hole at that location and pass the cables through from underneath. Also, you must break out the tabs on the rear of the mounting base using needle nose pliers (Figures 24-25).**

2. Insert all cables through the 1" (25mm) hole from beneath the mounting surface.
3. Pass the cables through the grommet (if the cable hole is underneath the mounting bracket) then press the grommet in place around the cables and into the 1" (25mm) hole.
4. Pass the cables through the mounting base, out the top of the mounting bracket.
5. Place the mounting bracket on the mounting surface aligned with the drilled holes. Insert the four flathead wood screws into the mounting holes and tighten fully (Figure 23).

**Optional: If the cables pass outside the mounting bracket, install the hole cover over the hole and fasten in place using the two #8 x 7/8" (22mm) wood screws (Figure 24).**

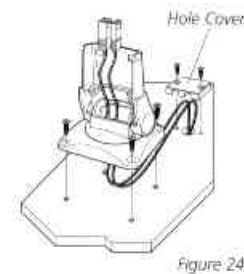
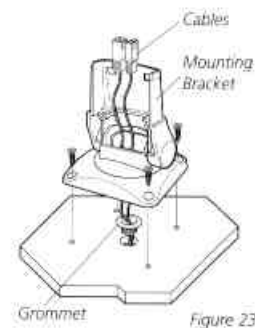
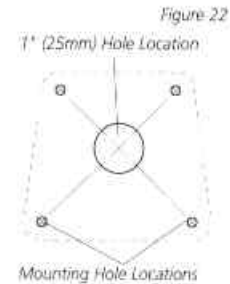

# INSTALLATION

## CONTROL HEAD INSTALLATION

### Step Five - Assembling the Connector Holder

1. Insert the cable connectors into the connector holder. The cable connectors are labeled, and there are corresponding labels on the connector holder (Figure 26). The slots for the connectors are keyed to prevent reverse installation, so do not force the connector into the holder.
2. Carefully pull the excess cable from beneath the - mounting surface so the connector holder aligns with the mounting holes on the front of the mounting bracket (Figure 27).
3. Snap the support plate to the rear of the connector holder (Figure 28).
4. Insert the connector holder into place and use the two #6-32 x  $\frac{3}{4}$ " (9mm) screws to fasten it to the mounting bracket (Figure 28).
5. Install the control head by sliding it onto the mounting bracket until it is fully seated. To remove the unit simply depress the latch on the rear of the unit and lift (Figure 29).

**Your Humminbird is now ready for operation.**

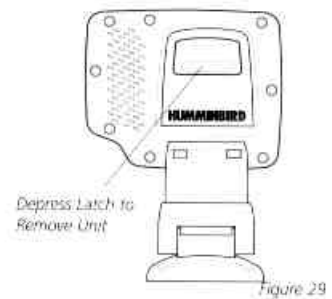
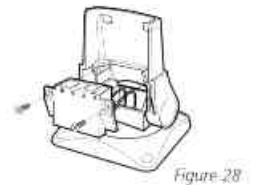
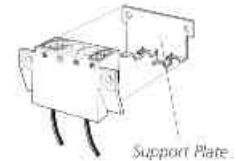
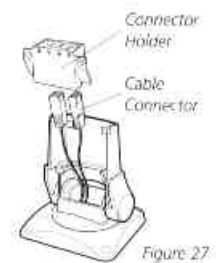
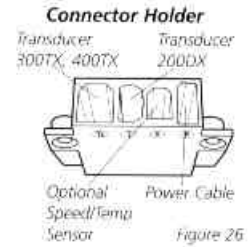

# INSTALLATION

## TEST THE INSTALLATION

### **TEST THE INSTALLATION**

Testing should be performed with the boat in the water, however you can initially confirm basic operation with the boat trailered.

Press POWER once to turn the unit on. There will be an audible chirp when any button is pressed to confirm the button press. If the unit does not power-up, ensure the unit is fully seated on the mount and that power is available.

The first screen provides four options: Start-up, Options, Simulator, and Diagnostic. A message at the bottom of the screen indicates the transducer connection. If no transducer is detected (or one is not connected), the message will indicate this and the unit will go into simulator after the initial screen times out.

***Note: the transducer must be submerged in water for reliable transducer detection.***

If a transducer is detected, the unit will enter “Start Up” or normal operation unless you choose another option. If you do not press any button before the timer reaches “0”, the normal operation screen is displayed. If the boat is in water, sonar data appears.

If the bottom is visible on screen with a digital depth readout, the unit is working properly. Ensure the boat is in water greater than 2’ but less than the depth capability of the unit and the transducer is fully submerged. Remember the sonar signal cannot pass through air.

If the unit is working properly gradually increase the boat speed to test high-speed performance. If the unit-functions well at low speeds but begins to skip or miss the bottom at higher speeds, the transducer requires adjustment. Refer to the appropriate transducer installation section for more detail.

***Note: it is often necessary to make several incremental transducer adjustments before optimum high-speed performance is achieved.***

Important: For Transom Mount transducer installations, install the third mounting screw after the final transducer adjustments.



Humminbird • 3 Humminbird Lane • Eufaula, Alabama 36027



# USING THE 200DX

## HOW SONAR WORKS

### HOW SONAR WORKS

Your Humminbird unit uses sonar to locate and define underwater objects, define the bottom terrain, as well as determine distance.

Sonar technology is based on sound waves. Your Humminbird unit sends out a sound wave signal. With this signal it determines distance by measuring the time between the transmission of the sound wave and when the sound wave is reflected off an object. Your Humminbird uses the reflected signal to interpret location, size and composition of an object.

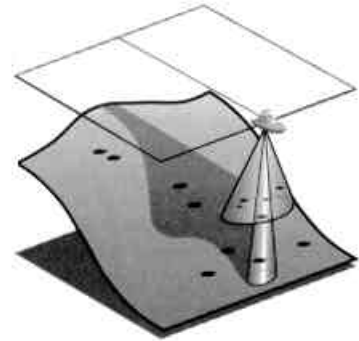

Sonar is very fast. A sound wave can travel from the surface to a depth of 240' (70m) and back again in less than 1/4 of a second. It is unlikely that your boat can "outrun" this sonar signal.

The 200DX is a dual frequency, dual beam unit, and generates two distinct sonar signals - one narrow, one wide. Each signal is optimized for a particular purpose. First, the center beam transmits at a frequency of 200kHz in a 20 degree (narrow) symmetrical pattern for greater depth capability and excellent detail. Information from this center beam is used to draw the graphic representation of the bottom on the display.

Second, the wide beam transmits at a frequency of 83kHz in a 53 degree (wide) symmetrical pattern for greater area of coverage. Information from the wide beam is used to accurately detect the presence and location of fish. A wide beam has a large area of (coverage but limited resolution of detail. A narrow beam has excellent detail, but within a limited area of coverage.

The combination of the two beams and dual frequencies provides the combination of a large area of coverage and a high level of detail.

# USING THE 200DX

## SIMULATOR OPERATION

Actual depth capability depends on factors such as bottom hardness, water conditions, and transducer installation. Unit will typically read to deeper depths in fresh water than in salt water

### **SIMULATOR OPERATION**

The 200DX contains a simulator that allows you to use the unit as if you are on the water. The simulator is invaluable for learning how to operate the 200DX.



There are two ways to start the simulator. If the unit is powered off, press and hold the POWER button for approximately three seconds until you hear a continuous chirp.

The simulator can also be started by selecting the Simulator option on the start-up screen after you power-up the unit. When this screen is shown, simply press the DOWN ARROW until Simulator is highlighted. When the screen times out, the unit will be in simulator mode.

When in simulator operation, the 200DX responds to control inputs as if it is in actual operation, so feel free to experiment or to customize the unit for your particular operation.

To exit Simulator mode, power the unit off.

***When in simulator mode, the word "simulator" occasionally scrolls across the display indicating the information on-screen is not real sonar data.***

### **FEATURE MEMORY**

If your 200DX is installed with a transducer connected, any changes you make to the set-up or User Options (see Control Functions) while in Simulator are retained in the unit memory. This allows you to use simulator to experiment with the various set-up options and retain your selected settings for normal operation.

# USING THE 200DX

## WHAT YOU SEE ON-SCREEN

If you are using the 200DX in Simulator when no transducer is connected, any selected options are lost when the unit is powered off. The 200DX will return to Factory Settings, or options selected when last used with a transducer, if no transducer is connected.

**IMPORTANT:** A transducer must be connected to the 200DX in order to retain user settings selected when in simulator mode. If no transducer is detected the unit defaults to pre-selected options when powered off.

### ***What You See On-Screen***

Your 200DX uses a 128 x 64 matrix FSTN LCD display. This display provides outstanding viewability in all light conditions over a wide range of temperatures.

At initial power-up, the 200DX uses settings that were set at the factory. After initial use the 200DX will remember the settings you enter.

There are several elements on-screen that are common to all modes of operation.

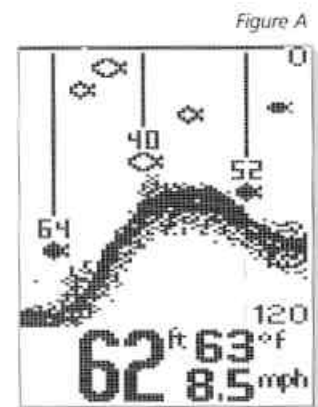

**Temperature/Speed.** The initial screen layout takes one of two basic forms depending on whether the optional Temp/Speed accessory is installed. Figure A shows the default view when the Temp/Speed accessory is installed. Figure B shows the default view when the Temp/Speed accessory is not installed.

**Depth.** The digital depth number shows the water depth directly beneath the transducer location.

**Depth Range.** The depth range is shown to the right of the screen. The upper number is 0 indicating the surface of the water. The lower number is one of the nine depth ranges available that best matches the depth of the water. As the depth of the water changes the range changes as necessary in order to retain a bottom representation on-screen.

# USING THE 200DX

## WHAT YOU SEE ON-SCREEN

When in Auto mode, the horizontal line at the top of the screen is the “zero line,” representing the surface of the water. Occasionally there is a gap in this line. This gap indicates the unit is updating the display even if the bottom is not visible on-screen or if the bottom information is not changing.

New sonar information appears on the right side of the graphic area of the display and moves to the left as new information is displayed. The 200DX automatically selects the appropriate depth range to show the depth of water beneath the transducer. This range is selected so the bottom representation is typically shown about 2/3 down the display.

**Bottom.** The graphic depiction of the bottom provides an effective tool for understanding the composition of the bottom. If the bottom is hard and smooth the bottom depiction is narrow and dense. If the bottom is soft mud or sand, the depiction will be thick and less dense. This indicates much of the signal is absorbed by the soft bottom. If the bottom is rocky or rugged in composition the depiction is of varying density and textured in appearance.

Wave action also affects the bottom depiction. The information drawn is a distance measurement so if the boat is moving up and down over flat bottom, the bottom depiction often appears in regular variations that match wave timing.

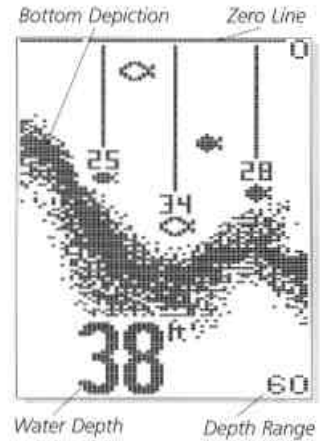
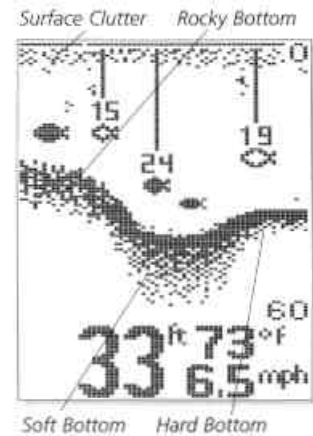

Figure B



Soft Bottom Hard Bottom

# USING THE 200DX

## WHAT YOU SEE ON SCREEN

**Structure.** Structure is defined as any object physically attached to the bottom. The sonar configuration of the 200DX is optimized to give the most accurate depiction of bottom structure possible. Grass, trees, stumps, wrecks or other debris are accurately displayed, however the depiction of these objects varies with boat speed and direction. The best way to learn to interpret structure is to operate the 200DX over a variety of known conditions and experiment with user functions to best represent those conditions on-screen.

**Surface Clutter.** Surface clutter is the layer of water near the surface that is rich in algae and other growth and often it aerated by wind or wave action. This area of water interferes with sonar transmission and often appears on-screen as regular clusters of individual dots near the 0 line.

**Thermoclines.** Thermoclines are sharp differences in water temperature. These are easily identified by the continuous nature of the return.

**Second Returns.** When a sonar signal is reflected off the bottom back to the transducer there is often enough energy left in the signal to be reflected off the surface of the water back to the bottom a second time. Second returns appear as a slightly weaker bottom representation exactly twice the depth of the primary bottom return. The second return is most likely to occur in shallow water and in areas of relatively hard bottom.

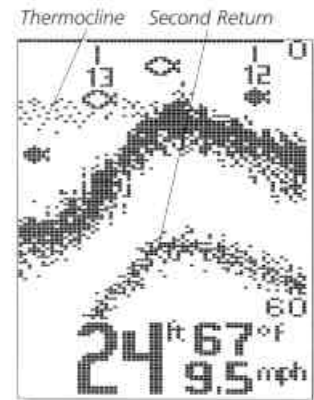

# USING THE 200DX

## CONTROL FUNCTIONS

**Fish ID.** The 200DX uses advanced signal processing to further evaluate any sonar return between the surface and the bottom. For instance a small school of Bait fish usually appears as a dense cluster of individual dots. If the return meets certain additional criteria, a fish symbol is assigned. There are three different size fish symbols used to indicate the intensity of the sonar return. While signal intensity is a good indicator of relative fish size, different species of fish have different sonar characteristics, so it is not always possible to distinguish fish size between varying species. The signal intensity is normalized for depth so a small fish close to the boat does not appear as a large fish symbol.

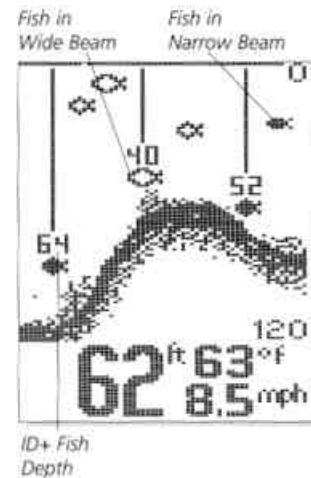

ID+ adds an additional piece of information to help the user locate fish. On selected fish symbols the digital depth of the designated fish is drawn to help locate the fish vertically.

The fish symbols indicate the sonar beam the fish is detected in. This gives you a reliable indicator of side to side location of the fish relative to the boat. Fish symbols that are hollow are detected in the wide beam and are around the boat. Solid fish symbols represent fish detected in the narrow beam and are directly under the boat.

## CONTROL FUNCTIONS

The 200DX uses a simple five button keypad for all user input. Press any button and an audible "chirp" confirms the control input. If a button has no function or is inappropriate for the situation an audible error is heard. The unit sounds multiple chirps.

**Power.** The Power button powers the 200DX up for normal operation. When the unit is on, POWER turns the unit off. POWER can also be used to go directly into Simulator mode To enter simulator, with the unit powered off, press and hold POWER for several seconds until a continuous chime is heard.



# USING THE 200DX

## CONTROL FUNCTIONS

**Light.** LIGHT controls the unit's display backlight. With the unit powered on, press LIGHT once to turn the backlight on "high." Press LIGHT a second time to turn the backlight on "low," and a third time turns the backlight off. The backlight is very effective for low-light and nighttime operation. When the backlight is on the 200DX will consume more power than with the backlight off. This is important when using the 200DX in a portable configuration powered by a separate battery, or when powering the unit from a trolling motor battery.

When powering the unit from a battery such as in portable applications, you can prolong the battery life by using the backlight at a minimum.

The three lower buttons, MENU, UP ARROW, and DOWN ARROW work together to control the 200DX menu-controlled user functions.

**Menu.** MENU displays a menu on-screen for adjustment. In normal operation, pressing MENU repeatedly cycles through all available menu headings. When a menu heading displays the full menu appears after a short pause. A menu remains on-screen for several seconds and can be adjusted by using the ARROW keys. If no adjustment is made in the allotted time, the menu disappears. If you want the menu to remain on-screen longer, press and hold MENU — the menu will remain on-screen indefinitely. Once you release the menu button, the screen will time out. Once a menu times out, it is still considered the active menu. Press MENU to bring up the last menu used.



**Arrow Keys.** The UP ARROW and DOWN ARROW make adjustments to menu functions. On the left side of every menu there are UP ARROW and DOWN ARROW symbols. The symbols indicate which ARROW button has a function in a particular situation. Either one or both ARROW buttons can be used to adjust the menu function. A hollow ARROW symbol means the corresponding ARROW button has no function. Pressing that button will result in no adjustment and the error audible will be heard.

# USING THE 200DX

## CONTROL FUNCTIONS

A solid ARROW symbol means the corresponding ARROW button can be used to affect the menu adjustment.

The ARROW buttons often can be used when no menu is on-screen. In these situations, pressing the ARROW button affects the function of the active (last-used) menu. This is a short-cut to menu operation. The menu appears on-screen while the adjustment is made and times out. A frequently used menu can be adjusted very quickly using this technique.



After an adjustment is made to a menu function, the menu times out after a few seconds and the unit returns to normal operation.

**Menu Layout.** All menus use the same basic layout. The shading at the top describes the menu function. The UP ARROW and DOWN ARROW symbols to the left of the menu indicate which buttons are available for adjustment. In menus that have several possible settings, a range of adjustment indicator shows the total range available and the current setting.

Within the menu are the options available. The selected option or current setting is highlighted in the black box. If no adjustment is made this is the selected setting. Press an ARROW button while the menu is displayed to select another option.

Several of the menus are multi-step. In some situations if an adjustment is made, additional options become available for further adjustment. Examples of these multi-step menus are Depth Range, Depth Alarm, and Zoom. See the detailed description of each function for further explanation.

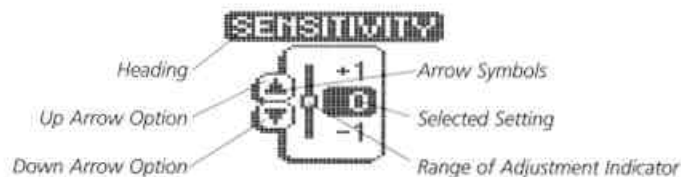



# USING THE 200DX

## MENU FUNCTIONS

### Menu Functions

**Sensitivity.** The Sensitivity function controls the sensitivity of the sonar receiver. The 200DX automatically adjusts the level of receiver sensitivity based on a number of factors including the depth of the water and the level of noise present. Noise can be caused by other electronic devices, engines, trolling motors, propeller cavitation, and hydrodynamic flow among others.



The user has the option of adjusting the Sensitivity higher or lower based on personal preference. You can select one of 11 sensitivity settings from -5 to +5. A setting of 0 (factory setting) has no effect on the automatic sensitivity control. Increasing the sensitivity (+1 through +5) enables the Unit to display the information from progressively smaller sonar returns. By decreasing the sensitivity bias (-1 through -5) the unit effectively filters small sonar returns.

In murky or muddy water it is often helpful to reduce the sensitivity. This prevents the display from being cluttered with sonar returns from debris or suspended particles. In very clear or very deep water, it may be helpful to increase the sensitivity since even the smallest sonar return may be of interest to the user.

To adjust Sensitivity, press MENU repeatedly until the Sensitivity heading is displayed. When the Sensitivity menu appears, use the UP ARROW to increase the sensitivity or the DOWN ARROW to reduce sensitivity. To sequence through the available settings, press and hold either ARROW button. Release the button at the setting you want to change.

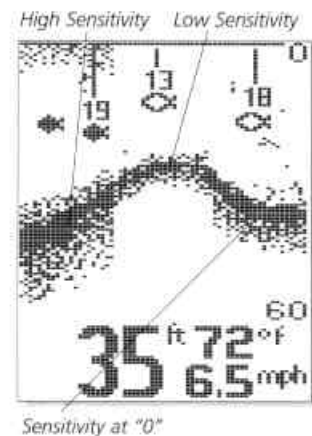

# USING THE 200DX

## MENU FUNCTIONS

After an adjustment is made, the menu disappears and the new sensitivity setting is in effect. If additional time is needed to study a menu press and hold the MENU button and the menu will remain on-screen indefinitely. If you need to make an additional adjustment, press the UP ARROW or DOWN ARROW button.

**Depth Range.** The Depth Range function controls the vertical distance displayed on the graphic area of the display. There are nine depth ranges available. The top of the range is always 0, or the surface of the water. Ranges of 0-15', 0-30', 0-60', 0-120', 0-180', 0-240', 0-360', 0-480', and 0-600' are available. In the metric version, ranges of 0-5, 0-10, 0-20, 0-40, 0-60, 0-80, 0-110, 0-150, and 0-185 meters are available. The range that positions the bottom depiction closest to the bottom of the screen, will best utilize the available display resolution.

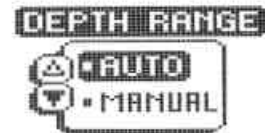

The 200DX automatically adjusts the depth range depending on the depth of the water. The unit tries to maintain the bottom depiction about 2/3 down the total range (for example, in 20' (6m) of water the 0-30' (0-10m) range would be selected). This provides the best display resolution and therefore the best target separation possible.



The Depth Range can be adjusted manually. Press MENU repeatedly until the Depth Range menu is visible. Two options are available: Auto and Manual.

The manual setting enables you to adjust the current depth range setting. The unit no longer adjusts the Depth Range to the most appropriate range for bottom display. Often, the bottom may not be visible on-screen. The digital depth readout always determines the depth of the bottom, even it is not visible on-screen.

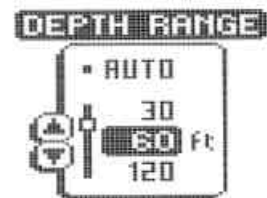

# USING THE 200DX

## MENU FUNCTIONS

Using manual Depth Range control, you can view sonar information from the area near the surface in great detail.

To return to automatic Depth Range control, press the MENU button until the Depth Range menu appears on-screen and use the UP ARROW to select AUTO.

**Zoom.** Zoom is similar to Depth Range because it controls the range of information displayed on screen. Zoom, however, allows selection of ranges beneath the surface so any area of water between the surface and the bottom can be enlarged to provide more detailed information. By using the full display to show a small area of coverage, the effective display resolution is increased and the unit's ability to separate close targets is enhanced.

There are four Zoom ranges available: 7 ½' (2m), 15' (5m), 30' (10m), and 60' (20m). These ranges are not directly user controlled but are instead dependent on the current depth range. In shallow water, when the 15' (5m) or 30' (10m) range is in use, the Zoom range is 7 ½' (2m). If the 60' (20m) or 120' (40m) range is in use, the Zoom range is 15' (5m), if a 180'-480' (60-150m) depth range is in use, the Zoom range is 30' (10m), and if a 600' (185m) range is in use, the Zoom range is 60' (20m).

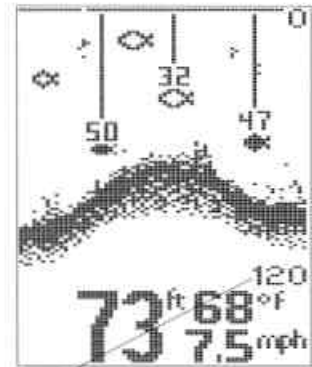

Depth Range



Upper Zoom Limit

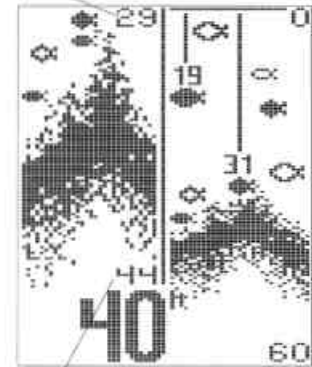

Lower Zoom Limit

# USING THE 200DX

## MENU FUNCTIONS

The Zoom range is shown on the left side of the screen and full range information is shown on the right side of the display. Zoom can either operate automatically, in which the Zoom range is constantly adjusted to show the bottom, or manually, in which the user controls the location of the Zoom range.

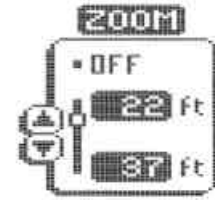

Automatic Zoom is especially helpful when looking for structure or bottom detail. The Automatic Zoom keeps the bottom in view even in quickly changing terrain, but is most useful in flatter areas without considerable depth variation. Manual Zoom provides detailed information of any area from the surface to the bottom. In manual Zoom, the Zoom range does not move as the terrain changes.

When the range is shown in the menu, the upper number represents the top of the current Zoom range. The lower number represents the bottom of the Zoom range. Use the UP and DOWN ARROW buttons to move this range. The upper number can never be less than 0 (the surface of the water), and the lower number can never be greater than the active depth range. The difference between the two numbers (the Zoom range) is preset and determined by the active depth range.

Once manual Zoom is selected, the display appears the same as in Auto Zoom, but the zoom range does not change automatically.

To disable Zoom, press the MENU button until the Zoom menu is on-screen. Use the up ARROW to highlight Off, and let the menu time out.

When the unit is powered off, the Zoom menu returns to Zoom Off.

# USING THE 200DX

## MENU FUNCTIONS

**Depth Alarm.** The 200DX contains an audible alarm to warn you of shallow water depths. The alarm is adjustable to depths of 2' (.6m) to 99' (30m). When the alarm is enabled, an audible alarm sounds if the water beneath the boat is equal to or less than the selected alarm depth. The alarm sounds continuously for about five seconds and then intermittently to remind you that you are still in shallow water.

**Fish Alarm.** The Fish Alarm alerts you to the presence of fish, or other targets not connected to the bottom. The Fish Alarm has three different settings that correspond to the three different size fish symbols shown on-screen.

The default setting is "OFF." With the "Large fish only" setting, the 200DX alarms on only those targets that are represented by the large fish symbols. The 200DX can be set to alarm on only large and medium fish or set to alarm on all fish.

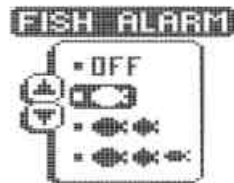
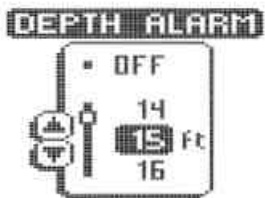

# USING THE 200DX

## MENU FUNCTIONS

Once the Fish Alarm is enabled, the 200DX emits an audible beep when the selected size fish symbol appears on-screen. The sound is slightly different for each of the three fish symbol sizes, so with practice, it is possible to distinguish the size of the detected fish without looking at the unit.

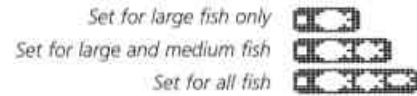

**Triplog.** Triplog provides a running log or information based on input from the Temp/Speed sensor.

**Since Triplog requires information from the Temp/Speed sensor to operate, if this sensor is not detected by the 200DX, the Triplog menu will not appear as an option.**

Triplog provides seven pieces of information: the current digital depth, water surface temperature, current boat speed, the distance traveled since the 200DX was powered up or reset, the average speed, the total time elapsed since power-up or reset, and the input voltage from your boats electrical system.

The time, speed and distance calculations are useful for tracking your progress on a trip. The input voltage is useful for determining the condition of the charging system of the boat. When used in a portable application or whenever the 200DX is operated from a battery source, the voltage number can be used to determine battery life. The 200DX will operate at voltages from 10 to 20 VDC. Voltages in excess of 20 or less than 10 VDC cause the unit to power off.

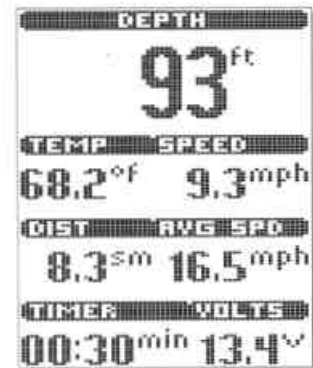

# USING THE 200DX

## MENU FUNCTIONS

**Options.** The Options Menu is a series of linked menu functions used initially to set your preferences. Once your preferences are selected it is unlikely these functions need to be accessed during the normal operation of the product.



The Options menu works differently than other menu functions in that all of the options must be cycled through in order to return to normal operation. There are six Option menus: Units, Fish ID, Numeral size, Bottom Black, Diagnostic, and Reset.

**Units Speed.** The Units Speed function allows the user to elect the units or measurement for the speed readout. Both MPH or statute miles per hour and KTS or nautical miles per hour are available. The 200DX remembers this selection even when the unit is powered off.



**Units Depth/Speed.** Only available on metric versions, the Units Depth/Speed function allows the user to select the units of measurement for the depth and speed readout. MT/KPH (meters/kilometers per hour), MT/KTS (meters/nautical miles per hour), FEET/MPH (feet/statute miles per hour) and FEET/KTS (feet/nautical miles per hour), are available. The 200DX remembers this selection even when the unit is powered off.

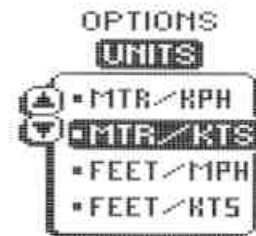

# USING THE 200DX

## MENU FUNCTIONS

**Fish ID.** There are three selections available: Off, ID+ ON, and Adjust. The factory setting is ID+ On. With Fish ID Off, sonar returns are displayed as “raw” information. There is no interpretation made by the unit. Selecting ID Off also disables the fish alarm.

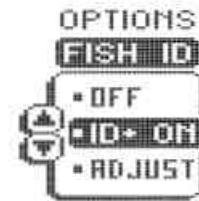

ID+ On enables the 200DX to interpret the raw sonar data, and using a variety of techniques, depict appropriate target returns as one of three different size fish symbols. Further identification shows whether the fish is in the wide or narrow beam. The 200DX also displays the depth beneath the surface with the corresponding fish symbol.

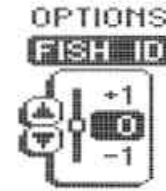

Selecting Adjust and making incremental changes enhances the fishfinder's ability to identify sonar returns as fish symbols.

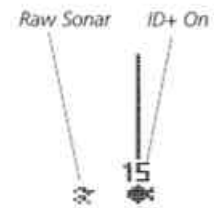

Increasing the value to a number greater than zero shows more fish symbols on-screen. In this case smaller sonar returns will be depicted as fish symbols. This is useful for identifying many smaller sonar returns (such as baitfish) as fish symbols.

Decreasing the value to a number less than zero shows fewer fish symbols on-screen. In this case smaller sonar returns are disregarded. This is useful for eliminating many small sonar returns when seeking larger species of fish.

The 200DX remembers this selection even when the unit is powered off.

**Numeral Size.** Two options are available: Big and Small. The factory setting is Big. With this setting, the digital depth and speed and temp numerals are drawn large enough to be read from across the boat. The big numerals occupy space on the display that could be used for the graphics area. Hence the small numerals option. With small numerals selected a greater amount of the display area is available for the graphic view. This effectively increases the display resolution of the unit.



Numeral Size settings are remembered when powered off.



# USING THE 200DX

## MENU FUNCTIONS

**Bottom Black.** There are two selections available: Off and On. The factory setting is Off. With this setting the 200DX displays the bottom using Structure ID. This allows you to determine the texture and relative hardness of the bottom. Selecting Bottom Black ON causes the unit to blacken in the display below the bottom. This gives the user easiest recognition of the bottom location even from a great distance.

The 200DX remembers the Bottom Black setting when powered off.



Bottom Black View

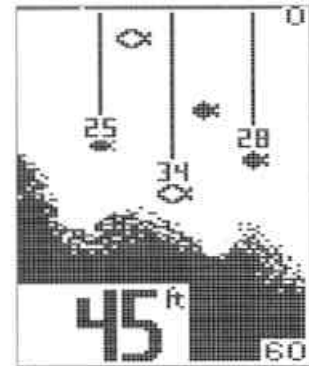

**Diagnostic.** Two options are available: Hide and Show. The factory setting is Hide. Selecting Show brings up the Diagnostic screen. See the Using Diagnostic section for more information.



# ADVANCED FEATURES

## USING DIAGNOSTIC

**Reset.** With the many User Options available to customize the 200DX, it is easy to configure the unit in such a way that it is detrimental to a particular use. By using the Reset function, all variable or user-controlled features of the 200DX are returned to the factory settings.



The Reset function is an important first step in troubleshooting problems to assure that a user selected setting is not the cause for the perceived problem.

### USING THE DIAGNOSTIC FEATURE

The 200DX contains a powerful diagnostic tool that can aid in determining the cause of a problem.

To use the Diagnostic feature, select the Diagnostic feature on the start-up menu on the initial screen. Diagnostic can also be accessed through the Options menu.

**Self Test.** Initially the 200DX will perform a self-test. This test confirms the operation of all internal circuitry. At the conclusion of the test one of two messages will appear. "Passed" indicates the internal test discovered no failures, "Failed" indicates a significant internal problem was discovered and the unit requires factory service. A code number appears that tells repair personnel where the problem is.



**Transducer Connection.** The first connection tested is Transducer input. If a transducer is detected, the message "connected" appears. If a series of dashed lines is shown no transducer is connected or there is a problem with the transducer or cable.

If you are using multiple transducers, switch between transducers to confirm the connections for each.

# ADVANCED FEATURES

## USING DIAGNOSTIC

**Boat Speed/Water Temperature Connection.** Other connections tested include the boat speed and surface water temperature sensors. These accessory sensors can be purchased independently or together as a single sensor (see the Humminbird Accessories catalog). If the sensors are connected and working properly a “connected” message appears.

The speed input feature only works when the boat is in motion as the paddle wheel or the speed sensor must rotate to be detected.

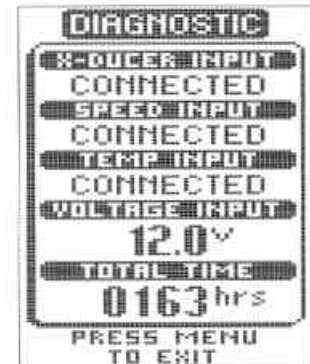

**Voltage Input.** Another connection tested is the voltage input, and is especially helpful in diagnosing input voltage problems. The current input voltage is displayed. If voltage fluctuations or power supply in excess of 20 VDC or less than 10 VDC is suspected, use the diagnostic screen to confirm input voltage. Often small outboard motors do not effectively regulate voltage when operated at high engine speeds.

Use Diagnostic while running the boat at high speeds to show the voltage gain. Also, if you are using the 200DX in portable configuration or from the trolling motor battery Diagnostic can be used to evaluate the health of the battery by showing the current voltage.

**Total Time.** The total time category indicates the total time the unit has been in use since shipped from the factory. It is normal for some hours to appear in the total time when the unit is new due to factory testing. While this is often of interest to the user it is primarily a diagnostic tool for the repair technician should the unit need service.

# SPECIFICATIONS

Operating Frequency	200kHz & 83kHz
Power Output	250 Watts (RMS) 2000 Watts (Peak to Peak)
Area of Coverage	Narrow: 20° at -10db Wide: 53° at -10db
Power Requirement	10 – 20 VDC
Display	FSTN LCD
LCD Matrix	28 H x 64 V
Viewing Area	2.90" H x 2.35" V (7.3cm H x 5.97cm V)
Mounting	Quick Disconnect Mount
Unit Size	6 ¾" H x 6 ¼" W x 4 ¼" D (17.1cm H x 15.9cm W x 10.5cm D)
Transducer (Standard)	XT-6-20
Transducer Cable Length	20' (6 meters)
Depth Range	15', 30', 60', 120', 180', 240', 360', 480', & 600' (5, 10, 20, 40, 60, 80, 110, 150, & 185 meters)
Zoom Ranges	7 ½', 15', 30', & 60' (2, 5, 10 & 20 meters)

# MAINTENANCE AND WARRANTY

## MAINTENANCE

### MAINTENANCE

Your Humminbird fishfinder is designed to provide years of trouble free operation with virtually no maintenance. Follow these simple procedures to ensure your Humminbird continues to deliver top performance.

- If the unit comes into contact with salt spray simply wipe the affected surfaces with a cloth dampened in fresh water. Do not use a chemical glass cleaner on the lens. Chemicals in the solution may cause cracking in the lens of the unit.
- When cleaning the LCD protective lens, use a chamois and non-abrasive, mild cleaner. Do not wipe while dirt or grease is on the lens. Be careful to avoid scratching the lens.
- If your boat remains in the water for long periods of time, algae and other marine growth can reduce the effectiveness of the transducer. Periodically clean the face of the transducer with liquid detergent. Pivoting the transducer up in the bracket may allow better access for inspection or cleaning.
- If your boat remains out of the water for a long period of time, it may take some time to wet the transducer when returned to the water. Small air bubbles can climb to the surface of the transducer and interfere with proper operation. These bubbles dissipate with time, or you can wipe the face of the transducer with your fingers after the transducer is in the water.
- Never leave the fishfinder in a closed car or trunk - the extremely high temperatures generated in hot weather can damage the electronics.

# MAINTENANCE AND WARRANTY

## TROUBLESHOOTING

### TROUBLESHOOTING

Do not attempt to repair the fishfinder yourself. There are no user serviceable parts inside, and special tools and techniques are required for reassembly to ensure the waterproof integrity of the housing. Repairs should be performed only by authorized Humminbird technicians.

Many requests for repair received by Humminbird involve units that do not actually need repair. These units are returned “no problem found.” If you have a problem with your Humminbird, use the following troubleshooting guide before calling Customer Support or sending your unit in for repair. Your Humminbird fishfinder contains several tools that can aid in determining if there is a problem and how to isolate and repair the problem in many cases.

#### **1. *Nothing happens when I turn the unit on.***

Check the power cable connection at both ends. Be sure the cable is connected correctly to a reliable power source - red lead to positive, black lead to negative or ground. Ensure the power available at the mount is between 10 and 20 VDC. If the unit is wired through a fuse panel, ensure the panel is powered. Often accessory fuse panels are controlled by a separate switch or the ignition switch. Also, often a fuse can appear to be good when in fact it is not. Check the fuse with a tester or replace it with a fuse known to be good.

Check the power connection to the unit. It is possible to force the power cable connector into the cable holder incorrectly. If the connector is reversed, the unit will not work. Examine the contacts on the back of the unit to ensure there is no corrosion. Finally, ensure the unit is firmly seated on the mount. The electrical contacts are not made until the unit is fully seated.

Ensure the metal cable retainer is properly installed in the mount. If not, the power connected may push out when the unit is put on the mount.

#### **2. *There is no transducer detected.***

Most Humminbird fishfinders have the ability to detect and identify that a transducer is connected. If at power up, a message indicates “transducer not connected,” only simulator operation is possible. First, ensure that an appropriate transducer connector is positioned correctly in the connector holder, and that the unit is fully seated on the mount. Your Humminbird fishfinder will work only with an appropriate transducer; check the accessory guide for compatibility.

# MAINTENANCE AND WARRANTY

## TROUBLESHOOTING

Second, inspect the transducer cable from end to end for breaks, kinks, or cuts in the outer casing of the cable. Also ensure the transducer is fully submerged in water. If the transducer is connected to the unit through a switch, temporarily connect it directly to the unit and try again. If none of these items identifies an obvious problem, the transducer itself is probably the problem. Be sure to include the transducer if returning the unit for repair.

### ***3. There is no bottom reading visible on the display.***

There are a number of possible causes for this condition. If the loss of bottom information occurs only at high boat speeds, the transducer needs adjusting. If the digital depth readout is working but there is no bottom visible on-screen, it is possible the depth range has been adjusted manually to a range lower than what is needed to display the bottom. Also, in very deep water, it may be necessary to manually increase the sensitivity setting to maintain a graphic depiction of the bottom.

If you are using a transducer switch to connect two transducers to the unit, ensure the switch is in the correct position to connect a transducer that is in water. (If a trolling motor transducer is selected and the trolling motor is out of water, no sonar information appears.)

If none of the above solve the problem, inspect the transducer cable from end to end for breaks, kinks, or cuts in the outer casing of the cable. If the transducer is connected to the unit through a switch, temporarily connect it directly to the unit and try again. If none of these items identifies an obvious problem, the transducer itself may be the problem. Be sure to include the transducer if returning the unit for repair.

### ***4. When in very shallow water, I get gaps in the bottom reading and inconsistent digital depth indication.***

Your Humminbird fishfinder will work reliably in water 2' (.6m) or deeper. The depth is measured from the transducer, not necessarily from the surface.

# MAINTENANCE AND WARRANTY

## TROUBLESHOOTING

### **5. *The unit comes on before I press POWER, and won't turn off.***

Check the transducer cable. If the outer jacket of the cable has been cut and the cable is in contact with bare metal, you need to repair the cut with electrical tape. If there is no problem with the cable, disconnect the transducer from the unit and see if the problem is corrected, to confirm the source of the problem.

### **6. *I get gaps in the reading at high speeds.***

Your transducer needs adjusting. If the transducer is transom-mounted, there are two adjustments available to you - height and running angle. Make small adjustments and run the boat at high speeds to determine the effect. It may take several tries to optimize high speed operation. This can also be a result of air or turbulence in the transducer location caused by rivets, ribs, etc.

### **7. *My unit loses power at high speeds.***

Most Humminbird fishfinders have over-voltage protection that turns the unit off when input voltage exceeds 20 VDC. Some outboard motors do not effectively regulate the power output of the engine's alternator and can produce voltage in excess of 20 volts when running at high RPMs. Your fishfinder displays input voltage in the Diagnostic screen. Use this readout to determine if the voltage exceeds 20 VDC.

### **8. *The screen begins to fadeout. Images are not as sharp as normal.***

Check the input voltage using Diagnostic. The fishfinder will not operate on input voltages below 10 VDC.

### **9. *The display shows many black dots at high speeds and high sensitivity settings.***

You are seeing noise or interference caused by one of several sources. Noise can be caused by other electronic devices. Turn off any nearby electronics and see if the problem goes away. Noise can also be caused by the engine. If engine noise is causing the interference, the problem will intensify at higher RPMs. Increase the engine speed with the boat stationary to isolate this cause. Propeller cavitation can appear as noise on-screen. If the transducer is mounted too close to the propeller, the turbulence generated can interfere with the sonar signal. Ensure that the transducer is mounted at least 15" (38cm) from the prop.



# MAINTENANCE AND WARRANTY

WARRANTY

## ***HUMMINBIRD ONE YEAR FULL WARRANTY***

First year repairs (from original date of purchase) on your Humminbird fishfinder are absolutely free. This does not include physical damage to the unit or its accessory items. Any modification or attempt to repair the original equipment or accessories by unauthorized individuals will void the warranty. Return the warranty registration card and retain your bill of sale for warranty verification. Accessories not manufactured under the Humminbird trade name are not covered by our warranty. **The customer is responsible for shipping charges to Humminbird.** Humminbird will provide ground UPS or Parcel Post shipping back to the customer free of charge. This warranty applies to the original purchaser only.

This warranty is in lieu of all other warranties expressed or implied and no representatives or persons are authorized to provide for any other liability in connection with the sale of our products. Humminbird reserves the right to perform modifications or improvement on its products without incurring the obligation to install the changes on units previously manufactured, sold, delivered, or serviced.

THIS IS A FULL WARRANTY AS DEFINED BY THE FEDERAL WARRANTY ACT  
EFFECTIVE JULY 4 1975.

# MAINTENANCE AND WARRANTY

## SERVICE POLICY

### **SERVICE POLICY**

*This Service Policy is valid in the United States only. This applies to Humminbird units returned to our factory in Eufaula, Alabama, and is subject to change without notice.*

All repair work is performed by factory-trained technicians to meet exacting factory specifications. Factory serviced units go through the same rigorous testing and quality control inspection as new production units.

Even though you'll probably never need to take advantage of our incredible service guarantee, it's good to know that we back our unit this well. We do it because you deserve the best. We will make every effort to repair your unit within three working days from the receipt of your unit. This does not include shipping time to and from our factory. Units received on Friday are usually shipped by Wednesday, units received Monday are usually shipped by Thursday, etc.

We reserve the right to deem any product unserviceable when replacement parts are no longer reasonably available or impossible to obtain.

After the original warranty period, a standard flat rate service charge will be assessed for each repair (physical damage and missing parts are not included). Please call our Customer Support Department to verify the service charge for your unit.

The standard service charge includes UPS or Parcel Post freight only. If charges are not prepaid, the unit will be returned COD. If you are experiencing problems related to bottom or depth readings please send your transducer along with your unit when sending for repair.

# **MAINTENANCE AND WARRANTY**

*CUSTOMER SUPPORT*

## ***CUSTOMER SUPPORT***

If you have any questions, call our  
Humminbird Customer Support Hotline: **1-334-687-0503**

Throughout the U.S. and Canada, hours are Monday-Friday, 8:00 a.m. to 5:00 p.m.  
Central time.

If after reading "Troubleshooting" you determine your unit needs factory service, please  
attach a description of the problem and send it with the unit to the address below.

If you are including a check please attach it to the unit.

**Humminbird  
Service Department  
Three Humminbird Lane  
Eufaula, AL 36027  
USA**