

X-65

INSTALLATION AND OPERATION INSTRUCTIONS

 LOWRANCE ELECTRONICS, INC.
12000 E. SKELLY DR., TULSA, OK 74128

TABLE OF CONTENTS

INTRODUCTION	3
INSTALLATION - BRACKET	3
POWER CONNECTIONS	4
TRANSDUCER	5
KEYBOARD BASICS	6
OPERATION	7
POWER/LIGHTS	7
MENUS	7
MODES	7
AUTOMATIC	10
SENSITIVITY	10
RANGE	11
Upper and Lower Limits	12
ZOOM	13
Automatic Operation	13
Manual Operation	14
GRAYLINE®	14
CHART SPEED	15
FISH ID	16
FISHTRACK™	16
CHART SETUP	17
FASTRAK™	17
GROUPS FASTRAK™	18
CHART CURSOR	18
DISPLAY ZOOM BAR	18
DISPLAY ZONE BAR	19
DIGITAL SONAR	19
ALARMS	20
DEPTH ALARMS	20
ZONE ALARM	21
FISH ALARM	21
ADJUST CHART SURFACE CLARITY	22
ADVANCED SIGNAL PROCESSING (ASP)	22
SYSTEM SETUP	23
AUDIO/DISPLAY	23
SYSTEM INFORMATION	24
UNITS OF MEASURE	24
RESET DISTANCE LOG	24
TEMPERATURE GRAPH	24
SIMULATOR	25
PRESET OPTIONS	25
KEEL OFFSET	25
CALIBRATE SPEED	26
WINDOWS SUMMARY	27
TROUBLESHOOTING	28
WARRANTY	31
UPS SHIPPING	32
INTERNATIONAL SERVICE INFORMATION	INSIDE BACK COVER

Copyright © 1996, Lowrance Electronics, Inc.
All rights reserved.

All features and specifications subject to change without notice.
All screens in this manual are simulated.

INTRODUCTION

The X-65 is the latest member of the Lowrance family that combines a high performance sonar with a wide screen. Using menu features and "soft-key" operation, the X-65 is also one of the easiest to use sonars that Lowrance® has ever built. The wide "Clearvision" screen shows the underwater world with high resolution and detail. The display and keyboard are also lighted for night operation. The X-65 has digital boat speed, surface water temperature, and distance travelled (log) screens.

SPECIFICATIONS

Dimensions	5 7/8"H x 7 3/4"W x 3 7/8"D
Transmitter Frequency	192 kHz
Transmitter Power	600 watts (p-p, typical) 75 watts (RMS, typical)
Display	Supertwist "Clearvision" LCD 160 vertical x 160 horizontal 25,600 total pixels

NOTICE!

The storage temperature for your unit is from -4 degrees to +167 degrees Fahrenheit (-20 degrees to +75 degrees Celsius). Extended storage in temperatures higher or lower than specified will damage the liquid crystal display in your unit. This type of damage is not covered by the warranty. For more information, contact the factory's Customer Service Department or your local service center.

INSTALLATION

MOUNTING

Install the X-65 in any convenient location, provided there is clearance behind the unit when it is tilted for the best viewing angle. Holes in the bracket base allow wood screw or through-bolt mounting. You may need to place a piece of plywood on the back of thin fiberglass panels to secure the mounting hardware. Make certain there is enough room behind the unit to attach the power and transducer cables.

The X-65's gimbal bracket will also accept the GBSA-1 swivel bracket adapter that lets you rotate the unit a full 360°.

The smallest hole that allows one power or transducer connector to pass through is 3/4". After the hole is drilled, push the transducer connector up through the hole first, then drop the power cable down through it.

After the cables have been routed, fill the hole with a good marine sealing compound. Offset the bracket to cover the hole. Route the power cable through the slot. Break out one of the holes in the back of the bracket for the transducer cable.

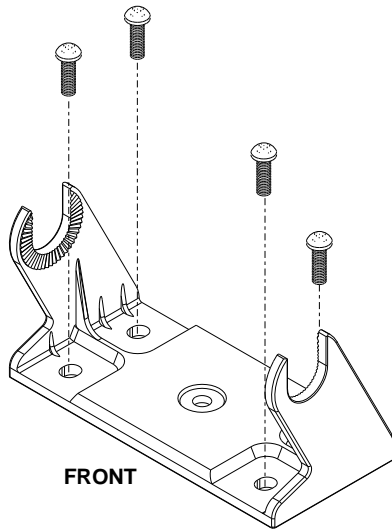

POWER CONNECTIONS

The X-65 works from a twelve-volt battery system. For the best results, attach the power cable directly to the battery. You can attach the power cable to an accessory or power buss, however you may have problems with electrical interference. Therefore, it's safer to go ahead and attach the power cable directly to the battery. If the cable is not long enough, splice #18 gauge wire onto it. The power cable has two wires, red and black. Red is the positive lead, black is negative or ground. Make certain to attach the in-line fuse holder to the red lead *as close to the power source as possible*. For example, if you have to extend the power cable to the battery or power buss, attach one end of the fuse holder directly to the battery or power buss. This will protect both the unit and the power cable in the event of a short. The X-65 Plus requires a 3-amp fuse.

IMPORTANT!

Do not use this product without a 3-amp fuse wired into the power cable! Failure to use a 3-amp fuse will void your warranty.

If you're installing a speed/temperature sensor, read it's mounting instructions. Route the sensor's cable to the X-65's power cable and plug it into the connector marked "SPEED/TEMP CABLE"

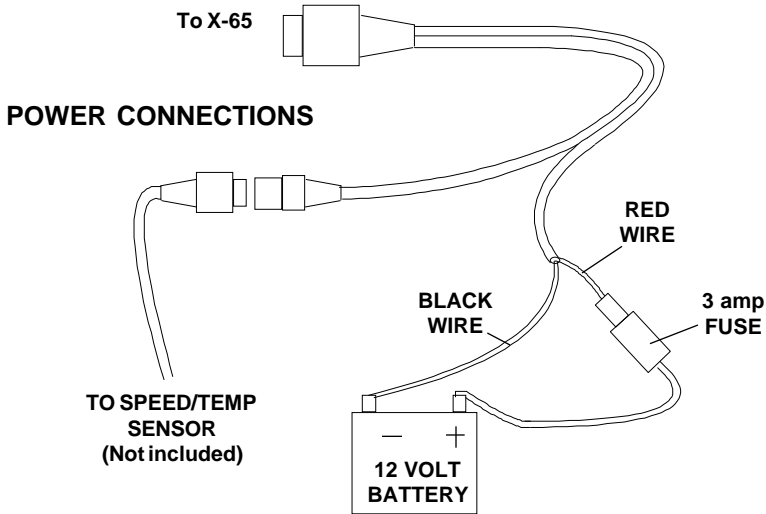

TRANSDUCER INSTALLATION

Some X-65s are packed with a HS-WSBK transom mount transducer. It can be installed on any outboard or stern-drive (inboard/outboard) powered boat. It can also be permanently installed inside the boat to "shoot-through" the hull on some fiberglass boats.

The "kick-up" mounting bracket helps prevent damage if the transducer strikes an object while the boat is moving. If the transducer does "kick-up", the bracket can easily be pushed back in place without tools.

Read the transducer's installation manual carefully before attempting the installation. Determine which of the mounting positions is right for your boat. Use extreme care if mounting the transducer inside the hull, since once it is epoxied into position, the transducer usually can't be removed without damaging it. Remember, the transducer location is the most critical part of a sonar installation. If it isn't done properly, the sonar can't perform to its designed potential.

KEYBOARD

The keyboard has keys arranged in two vertical columns beneath the arrow keys. The menu key near the bottom left corner of the keyboard activates the first menu page. The other keys are used to activate the alarm menu, make menu selections, and change modes.

MODE - Pressing this key switches the unit between different sonar modes.

MENU - Press this key to show the menus and gain access to most functions.

ARROW KEYS - These keys are used to make menu selections and to move objects on the screen.

ZOUT, ZIN - These keys let you zoom the screen in and out to see detail.

ALARM - Press this key to activate any of the sonar alarms.

PWR - This key turns the X-65 and it's lights on and off.

ENT, EXIT - These keys let you enter or erase values.

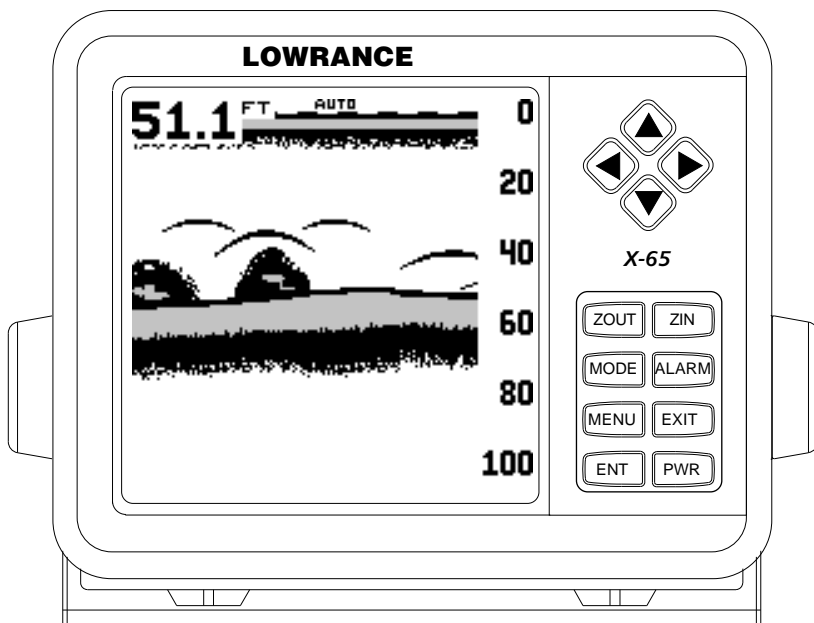

OPERATION

POWER/LIGHTS

To turn the X-65 on, simply press the PWR key. A screen similar to the one at right appears.

The menu on this screen let you adjust the screen contrast by pressing the left or right arrow keys. Press the EXIT key to erase these menu.

The PWR key also controls the lights. Once the X-65 is turned on, press the PWR key to turn the lights on. Press the PWR key again to turn the lights off.

To turn the X-65 off, press and hold the PWR key while a "countdown" appears on the screen. The unit will shut itself off when the countdown reaches zero. Release the PWR key.

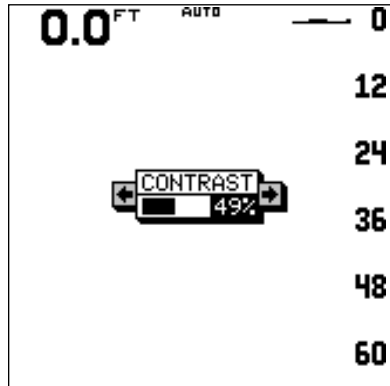

MENUS

The X-65 uses menus extensively to guide you through the functions and features of the unit. To use the menus, simply press the MENU key. The options on the menus let you to customize the unit to your particular needs and water conditions. Use the up and down arrow keys to move to different menus. The left and right arrow keys select and adjust menu items. If you ever get lost in a menu, simply press the EXIT key. This clears the menus from the screen.

MODES

The X-65 has four different modes: digital/chart, split-chart, full chart, and window groups. To select a different mode, simply press the MODE key. A screen similar to the one at right appears. Press the up or down arrow key to select the desired mode, then press EXIT key to erase the modes menu. A summary of the modes starts on the next page.

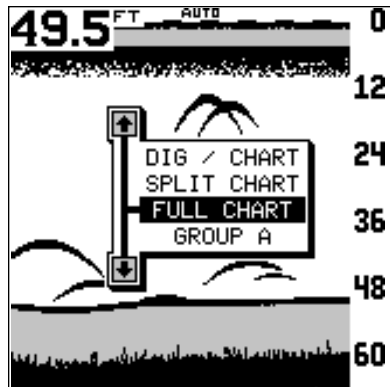

Full Chart

This is the default mode used when the X-65 is first turned on. The bottom signal scrolls across the screen from right to left. Depth scales on the right side of the screen makes it easy to determine the depth of fish, structure, and other objects. The line at the top of the screen represents the surface. The bottom depth shows at the top left corner of the screen. The word "AUTO" at the screen's top center shows that the X-65 is in the automatic mode, freeing you from sensitivity, range, and noise rejection adjustments.

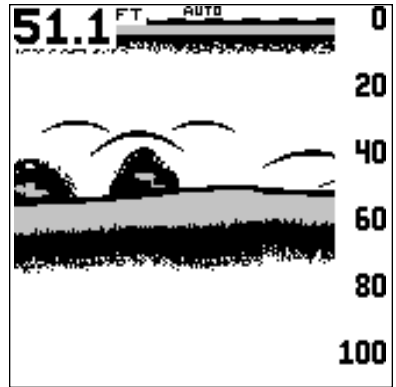

Split Chart

A split chart shows the underwater world from the surface to the bottom on the right side of the screen. The left side shows an enlarged version of the right side. The zoom range shows at the bottom of the screen. In this example, the zoom range is 2X, or two times the right side's view. By pressing the ZOUT and ZIN keys, you can change the left side's zoom from 2X to 4X and back.

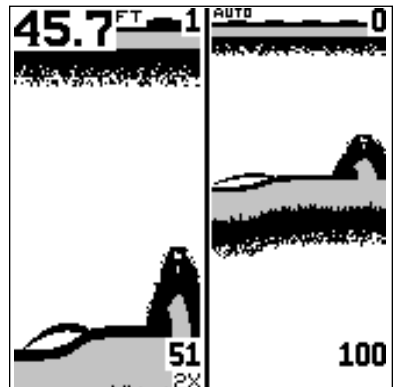

Digital/Chart

The digital/chart shows the chart on the right side of the screen. The left side has four digital boxes containing the water depth at the top of the screen, boat speed, distance travelled (log), and surface water temperature. At the bottom of the screen is a temperature graph. (Note: Speed, distance, and temperature displays require a speed/temperature sensor which comes with the X-65 Plus and must be purchased separately for the X-65.)

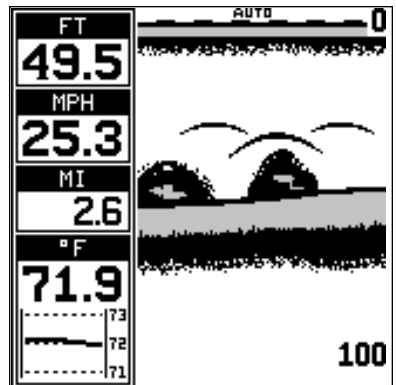

Window Groups

You can change the displays on the X-65 by using the windows feature. This lets you use different displays for your own fishing or boating situations. This feature gives you 8 different display screens in the window groups alone.

The screens available in the windows mode are divided into two or more windows per screen. Each screen of windows is called a "group". Group "A" as shown above has the digital depth display in one window, battery voltage in another, water temperature, speed, and distance travelled.

To use the windows feature, first press the MODE key. A screen similar to the one shown at right appears. Highlight the "Group" menu at the bottom of the screen. Now press the left or right arrow keys to sequence through the available groups. When the desired group appears, press the EXIT key to erase the modes menu.

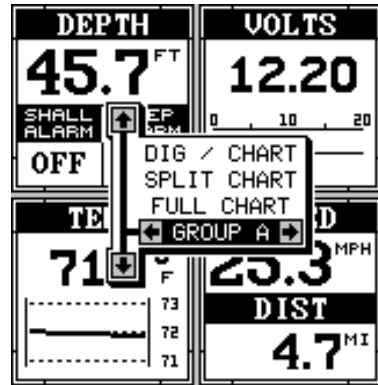
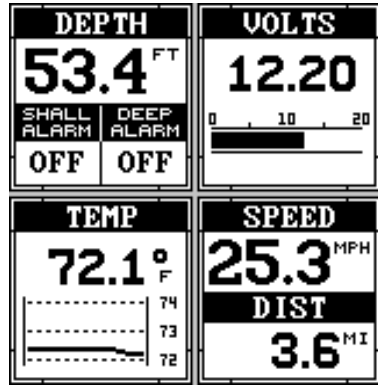

AUTOMATIC

When the X-65 is first turned on, the Automatic feature is enabled. This is indicated by the word "AUTO" at the top of the screen. The Automatic feature adjusts the sensitivity and range so the bottom signal is displayed in the lower half of the screen at all times.

To turn Automatic off, first press the MENU key, then press the up or down arrow keys until the "AUTO" menu appears. Press the left arrow key to switch to the manual mode. The letters "Man" appear at the top of the screen, indicating the unit is in the manual mode. To turn Automatic on, repeat the above steps to get the auto menu, then press the right arrow key.

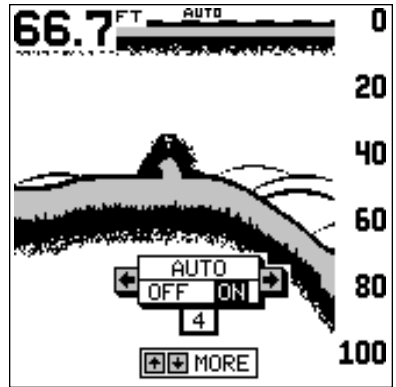

SENSITIVITY

The sensitivity controls the ability of the unit to pick up echoes. A low sensitivity level excludes much of the bottom information, fish signals, and other target information. High sensitivity levels enables you to see this detail, but it can also clutter the screen with many undesired signals. Typically, the best sensitivity level shows a good solid bottom signal with Grayline and some surface clutter.

When the X-65 is in the Automatic mode, the sensitivity is automatically adjusted to keep a solid bottom signal displayed, plus a little more. This gives it the capability to show fish and other detail.

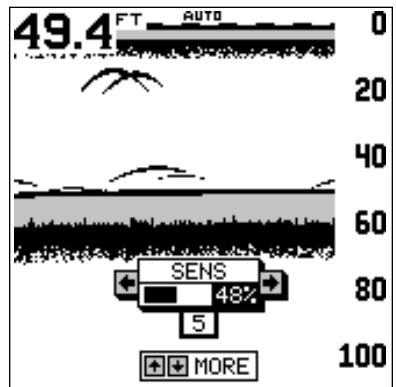

However, situations occur where it becomes necessary to increase or decrease the sensitivity. This typically happens when you wish to see more detail, so an increase in sensitivity is indicated. The procedure to adjust it is the same whether the unit is in the automatic or manual mode.

To adjust the sensitivity, press the MENU key, then press the up or down arrow keys until the "SENS" menu appears as shown above.

The sensitivity menu has left and right arrows, plus a horizontal bar graph. The graph gives a visual indication of the sensitivity level. The number to the right of the bar graph shows the percentage of sensitivity in use.

To increase the sensitivity level, press the right arrow key. As you press the key, the menu's bar graph will grow wider and the percentage will increase in value. You can also see the difference on the chart record as it scrolls. When the sensitivity is at the desired level, release the key.

To decrease the sensitivity level, press the left arrow key. The bar graph and percentage will decrease. When the sensitivity is at the desired level, release the key. When you reach either the maximum or minimum limit, a tone sounds.

To erase the menu, press the EXIT key.

RANGE - Automatic

When turned on for the first time, the X-65 automatically places the bottom signal in the lower half of the screen. This is called Auto Ranging and is part of the automatic function. Typically, the range cannot be changed manually while the unit is in automatic, as shown at right. However, depending upon the bottom depth and the current range, you can change the range to a different depth. In the example screen shown below, the bottom depth has descended to a point where you can change the range to 150 feet. To do this, simply press the right arrow key while the Auto Range menu is displayed. When you're finished with this menu, press the EXIT key to erase it.

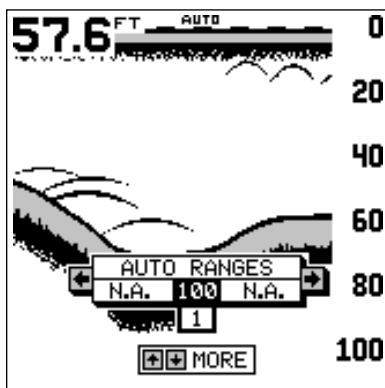

When the bottom depth has descended to a point where you can change the range to 150 feet. To do this, simply press the right arrow key while the Auto Range menu is displayed. When you're finished with this menu, press the EXIT key to erase it.

RANGE - Manual

The X-65 gives you complete control over the range when it's in the manual mode.

To change the range, first make certain the X-65 is in the manual mode. Next, press the MENU key and the up or down arrow keys until the range

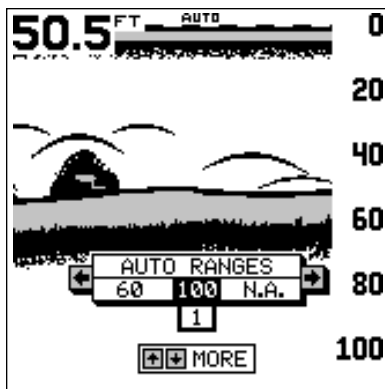

menu appears as shown at right. Press the left or right arrow keys to decrease or increase the range. The available ranges are 0-5, 10, 20, 30, 40, 60, 100, 150, 200, 300, 500, 800, and 1000 feet. After the desired range is displayed, press the EXIT key to erase the range menu.

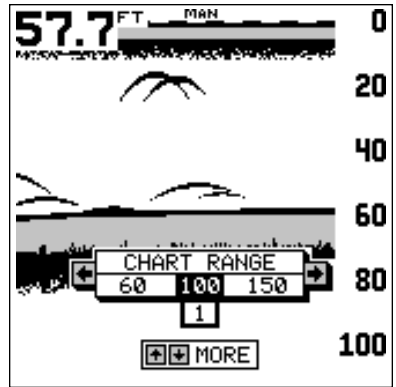

NOTE: The depth capability of the X-65 depends on the transducer installation, water and bottom conditions, and other factors.

UPPER AND LOWER LIMITS

You can enter any range when the unit is in the manual mode. The X-65 lets you enter any upper and lower limit, provided there is at least ten feet separating them. (On the screen below left, the upper limit is 0 and the lower limit is 100.) Using the upper and lower limit range option, we changed the range from 0 to 100 feet to 35 to 65 feet. This "zoomed" display to a 30 foot range.

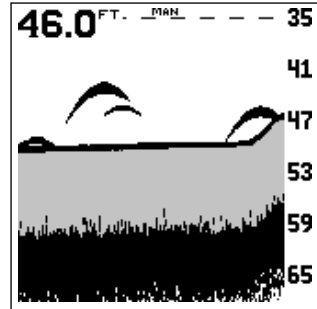
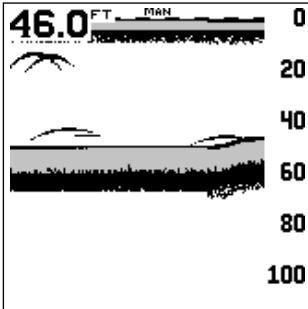

As you can see, the fish arches near the bottom are much larger and easier to see. In fact, a possible fish on the bottom shows on the enlarged screen that is not even visible on the left! Not only does this make it easier to see targets, but you can more accurately determine their depth, due to the expanded depth range.

To change the upper and lower limits, first press the MENU key. Next, make certain the X-65 is in the manual mode, then press the up or down arrow keys until the "Set Chart Limits" menu appears as shown at the top of the next page.

Now press the left arrow key to change the upper limit or the right arrow key to change the lower limit. A screen similar to the one below appears.

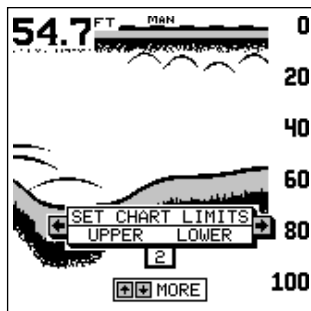

In this example, we're setting the upper limit. Use the up and down arrow keys to select the number, the right and left arrow keys to move to the next number. When the limit shows the desired depth, press the ENT key. The screen shown below appears.

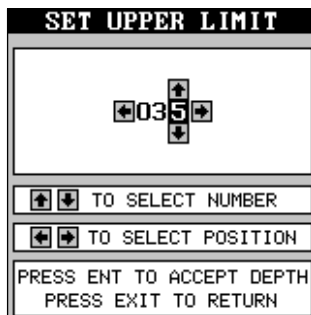

As you can see, the upper limit has changed from 0 to 35 feet. If you want to change the lower limit, repeat the above steps, press the right arrow key on the "Set Chart Limits" menu, and change the lower limit to the desired value.

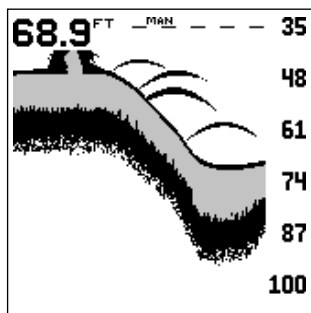

ZOOM

"Zooming" the picture is a common method used to enlarge small detail and fish signals. The X-65 gives you two different zoom sizes, plus a split screen zoom option. The zoom operation and adjustment is different in the automatic and manual modes.

ZOOM - AUTOMATIC MODE

The only way to zoom the screen in automatic mode is to simply press the ZIN (zoom-in) key. This enlarges all echoes on the screen to twice their normal size. If you press the ZIN key again, the screen is "zoomed" to four times normal size. To return the screen to 2X or normal, simply press the ZOUT (zoom-out) key until the desired zoom appears. When the X-65 is in the 2X or 4X zooms, "2X" or "4X" appears in the lower right corner of the screen, showing the current zoom mode.

ZOOM - MANUAL MODE

The Z-IN (zoom-in) and Z-OUT (zoom-out) keys enlarge and reduce the size of the echoes on the screen when the unit is in the manual mode, the same as the automatic mode.

However, you can manually adjust the zoom when the unit is in the manual mode. To do this, press the MENU key, then press the right or left arrow keys until the "CHART ZOOM" menu appears. Now press the right arrow key. A screen similar to the one at right appears.

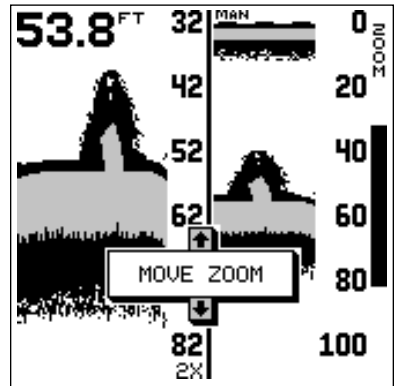

This is the split-screen zoom menu. A zoom bar shows at the far right side of the screen. All echoes between the top and bottom of the zoom bar are shown on the left side of the screen. Pressing the up or down arrow keys moves the zoom bar up or down. As you adjust the zoom bar, the range changes on the left side of the screen at the same time.

To return to the full-screen mode, simply press the EXIT key. This also erases the zoom bar and move zoom menu.

GRAYLINE®

GRAYLINE lets you distinguish between strong and weak echoes. It "paints" gray on targets that are stronger than a preset value. This allows you to tell the difference between a hard and soft bottom. For example, a soft, muddy or weedy bottom returns a weaker signal which is shown with a narrow or no gray line. A hard bottom returns a strong signal which causes a wide gray line.

If you have two signals of equal size, one with gray and the other without, then the target with gray is the stronger signal. This helps distinguish weeds from trees on the bottom, or fish from structure.

GRAYLINE is adjustable. Since GRAYLINE shows the difference between strong and weak signals, adjusting the sensitivity may require a different GRAYLINE level, also. The level chosen by the X-65 at power on is usually adequate for most conditions. Experiment with your unit to find the GRAYLINE setting that's best for you.

To adjust the GRAYLINE level, press the MENU key, then press the up

or down arrow keys until the GRAYLINE menu appears. A screen similar to the one at right appears. Press the left arrow key to decrease the gray level or the right arrow key to increase it. The percentage of GRAYLINE in use changes as the arrow keys are pressed. The bar chart also gives a graphical indication of the GRAYLINE level. You can see the change on the screen (both on the menu and on the chart record) as you press the keys. After you've finished, press the EXIT key to erase the menu.

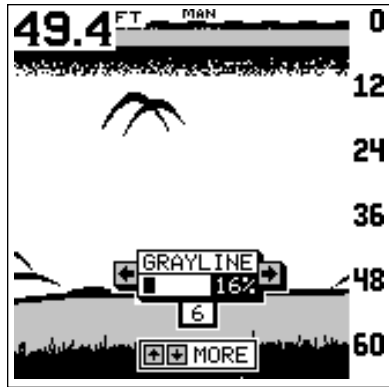

CHART SPEED

The rate echoes scroll across the screen is called the chart speed. It's adjustable by first pressing the menu key, then pressing the up or down arrow keys until the "CHT SPD" (chart speed) menu appears as shown below left. Increase the chart speed by pressing the right arrow key or decrease it by pressing the left arrow key. The percentage of chart speed in use changes as the arrow keys are pressed. The bar chart also gives a graphical indication of the chart speed. You can see the change on the screen (both on the menu and on the chart record) as you press the keys. After you've made the adjustment, press the EXIT key to erase the menu.

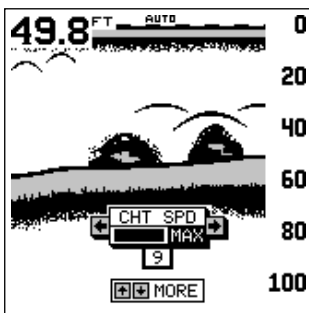

CHART SPEED MENU

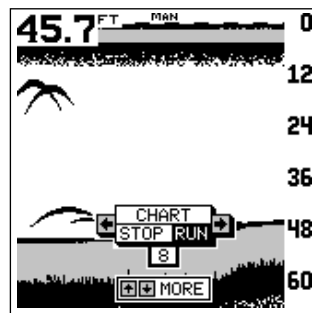

CHART STOP MENU

To stop the chart, press the menu key, then press the up or down arrow keys until the "CHART" menu appears as shown above right. Press the left arrow key to stop the chart. To start the chart again, press the right arrow key.

FISH ID

The Fish ID feature identifies targets that meet certain conditions as fish. The microcomputer analyses all echoes and eliminates surface clutter, thermoclines, and other signals that are undesirable. In most instances, remaining targets are fish. The Fish ID feature displays symbols on the screen in place of the actual fish echoes. There are four fish symbol sizes: tiny, small, medium, and large. These are used to designate the relative size between targets. In other words, it displays a small fish symbol when it thinks a target is a small fish, a medium fish symbol on a larger target, etc.

The microcomputer is sophisticated, but it can be fooled. It can't distinguish between fish and other suspended objects such as trotlines, turtles, submerged floats, air bubbles, etc. Individual tree limbs extending outwards from a group of limbs is the hardest object for the Fish ID feature to distinguish from fish.

You may see Fish ID symbols on the screen when actually, there are no fish. Practice with the unit in both the Fish ID mode and without to become more familiar with the Fish ID feature.

When the X-65 is turned on, the Fish ID feature is automatically turned on, also. To turn the Fish ID feature off, press the menu key, then press the arrow keys until the FISH ID menu appears. Press the left arrow key to turn the fish ID feature off. To turn the Fish ID feature on again, repeat the above steps, but press the right arrow key until the "ON" is highlighted. Any targets the microcomputer determines are fish will be displayed as fish symbols.

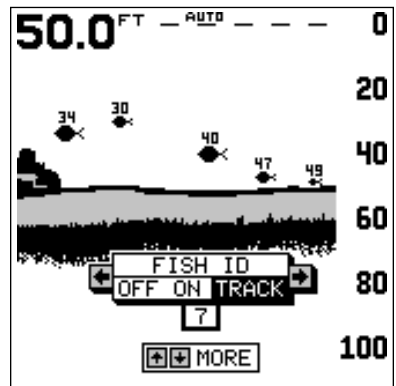

Remember, the Fish ID feature can't be used when the X-65 is in the manual mode. If you turn the Fish ID feature on when the X-65 is in manual, the microcomputer will turn the automatic feature on. If you turn automatic off when the Fish ID feature is on, the Fish ID feature will be turned off also.

FISHTRACK™

The FishTrack feature shows the depth of a fish symbol when it appears on the display. This lets you accurately gauge the depth of targets. This feature is available only when the Fish ID feature is on.

When the X-65 is turned on, FishTrack is enabled. To turn the FishTrack feature off, press the menu key, then press the up or down arrow keys until the FISH ID menu appears. Now press the left arrow key. Pressing it once switches the FishTrack feature off, but leaves Fish ID on. To turn FishTrack on, press the right arrow key, which highlights the "TRACK" label on the Fish ID menu.

CHART SETUP

The X-65 lets you customize the chart screen. To do this, press the MENU key, then press the up or down arrow keys until the "CHART SETUP" menu appears. Now press the right arrow key. The screen shown at right appears.

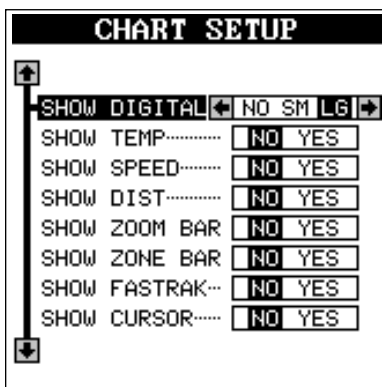

The digital depth display at the top left corner of the screen normally shows in large numbers. You can change this to smaller numbers or turn it off completely using the "Show Digital" menu at the top of this screen.

You can also turn the temperature, speedometer, distance log, zoom bar, zone alarm bar, fastrak, and cursor on or off using this menu. See below for more information on these items.

FASTRAK

This feature converts all echoes to short horizontal lines on the display's far right side. The graph continues to operate normally. FASTRAK gives you a rapid update of conditions directly under the boat. This makes it useful for ice fishing, or when you're fishing at anchor. Since the unit is not moving, fish signals are long, drawn out lines on a normal chart display. FASTRAK converts the graph to a vertical bar graph that, with practice, makes a useful addition to fishing at a stationary location.

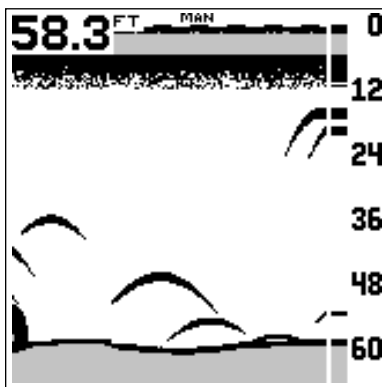

To turn FASTRAK on, highlight the "Show Fastrak" label on the "Chart

Setup" menu, then press the right arrow key. Press the EXIT key to erase the menu. A screen similar to the one at the bottom of the previous page appears. To turn Fastrak off, repeat the above steps.

Groups Fastrack

Several windows groups have a Fastrack screen that looks a little different than the Fastrack used on the full screen chart. Windows Fastrack, shown on the right side of this screen also converts echoes to short horizontal lines, but it also gives you scale lines to make it easier to determine the depth of the targets. You can use group "H" shown at right to help you learn how to use the Fastrack feature. Remember, Fastrack is only showing you the first column of echoes from the normal display as they appear. It is simply converting each dot to a horizontal line.

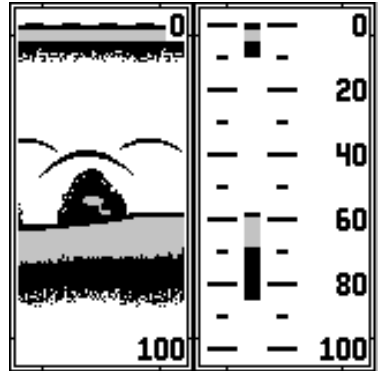
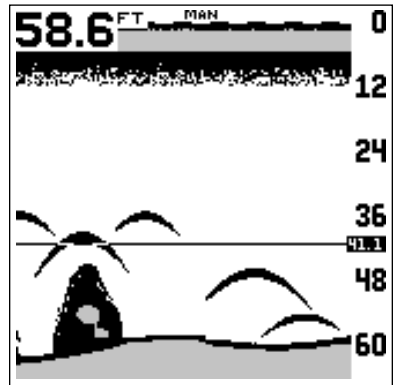

CHART CURSOR

The X-65 has a chart cursor that allows you to pinpoint a target's depth. The cursor is simply a horizontal line that extends across the display from left to right. A depth box at the end of the line on the right side shows the line's depth. In the example at right, the cursor (line) is at 41.1 feet.

To display the chart cursor, highlight the "Show Cursor" on the "Chart Setup" menu, then press the right arrow key. A screen similar to the one at right appears. Use the up and down arrow keys to move the cursor up or down to the desired depth.



To turn the chart cursor off, repeat the above steps. The X-65 returns to the sonar screen without the chart cursor.

DISPLAY ZOOM BAR

When the unit is in the split-screen zoom mode, the zoom bar doesn't normally show on the screen. The zoom bar shows the section of water on the right side of the screen that is being enlarged on the left side. To turn the zoom bar on continuously when the split-screen mode is on,

highlight the "Show Zoom Bar" on the "Chart Setup" menu, then press the right arrow key. Now press the EXIT key. If you're not in the split-screen mode, change to that mode. A screen similar to the one at right appears.

To turn the zoom bar off, repeat the above steps.

DISPLAY ZONE BAR

The zone alarm has a range bar. Any echoes that appear between the top and bottom of this bar triggers the zone alarm. This bar normally doesn't show on the screen. To turn the zone bar on continuously, highlight the "Show Zone Bar" on the "Chart Setup" menu, then press the right arrow key. Now press the EXIT key. A screen similar to the one at right appears. To turn the zone bar off, repeat the above steps.

See the Alarms section in this manual for more information on the zone alarm.

DIGITAL SONAR

When the X-65 is turned on, the digital depth display is located at the top left corner of the screen. This display comes from a separate digital sonar built into the unit. It displays only the bottom depth. If it loses the bottom, the last known depth will flash on the display. When the digital finds the bottom, it will automatically display the bottom depth again.

The digital sonar can be turned off, however this also turns all automatic features off also, such as auto sensitivity, auto ranging, and the Fish ID. feature.

To turn the digital off, first press the MENU key, then press the up or down arrow keys until the "DIGITAL SONAR" menu appears. Press the left arrow key to turn it off.

Note: Turning the digital sonar off also turns the automatic mode off, including Fish ID, and the depth alarms.

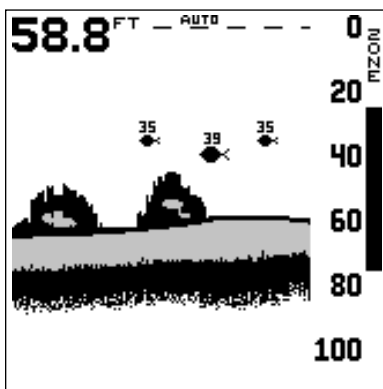
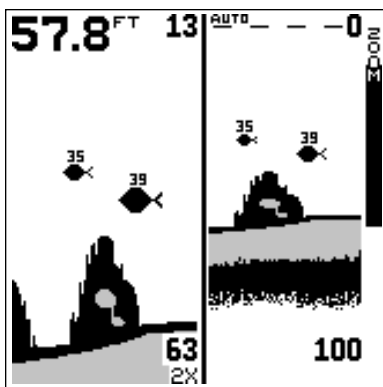

ALARMS

The X-65 has three different types of sonar alarms. The first is the Fish Alarm. It sounds when the Fish I.D. feature determines an echo or group of echoes is a fish. Another alarm is the Zone Alarm which consists of a bar. Any echo that appears inside this bar triggers this alarm. The last alarm is called the Depth Alarm. Only the bottom signal will trigger this alarm. This is useful as an anchor watch, a shallow water alert, or for navigation.

To adjust an alarm, first press the ALARM key. The screen shown at right appears. Follow the instructions below for setting each alarm.

DEPTH ALARMS

The depth alarms sound a tone when the bottom signal goes shallower than the shallow alarm's setting or deeper than the deep alarm's setting. For example, if you set the shallow alarm to ten feet, the alarm will sound a tone if the bottom signal is less than ten feet. It will continue to sound until the bottom goes deeper than 10 feet. The deep alarm works just the opposite. It sounds a warning tone if the bottom depth goes deeper than the alarm's setting. Both depth alarms work only off the digital bottom depth signals. No other targets will trip these alarms. If you turn the digital off, the depth alarms will be inoperative. These alarms can be used at the same time or individually.

To adjust the shallow alarm, highlight the "Shallow Depth" label. To adjust the deep alarm, highlight the "Deep Depth" label. Both alarms adjust identically. We'll use the shallow alarm as an example. Highlight the "Shallow Depth" label, then press the right arrow key. The screen shown at right appears.

Use the up or down arrow keys to select the number, the right and left keys to move from number to number in the depth. For example, to set the shallow alarm depth to 10 feet, press the right arrow key once, then press the up arrow key once. The changes

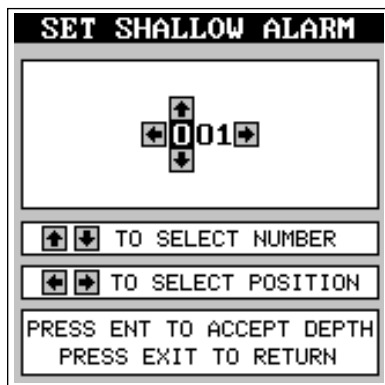
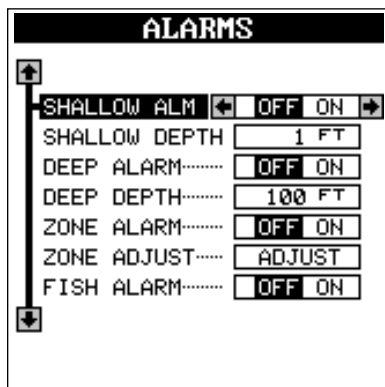

the second "0" to a "1". Next, press the right arrow key again and press the down arrow key once. This changes the "1" at the end of the number to a "0". The depth now shows 10 feet.



Press the ENT key to accept this setting. The X-65 returns to the alarms menu, showing a shallow depth of 10 feet. Now you can activate the alarm by highlighting the "Shallow Alm" label and pressing the right arrow key.

With the shallow alarm set at ten feet, anytime the digital display goes below ten feet, the shallow alarm sounds.

Set the deep alarm in the same manner. If the bottom depth reading goes below the deep alarm setting, the deep alarm will sound.

ZONE ALARM

The zone alarm is triggered when any echo passes inside the zone alarm bar, shown on the right side of the screen. To turn the zone alarm on, highlight the "Zone Alarm" label on the alarms menu, then press the right arrow key. To adjust the zone alarm, highlight the "Zone Adjust" label, then press the right arrow key. A screen similar to the one at right appears.

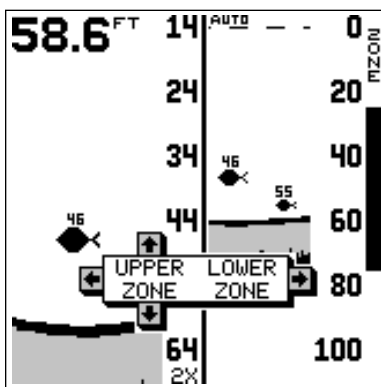

To adjust the top of the zone bar higher or lower, press the up or down arrow keys while the up and down arrows are surrounding the "Upper Zone" on the screen as shown above. To adjust the bottom of the zone bar, first press the right arrow key to move the arrows to the "Lower Zone" on the screen, then use the up or down arrow keys.

When the zone alarm is set, press the EXIT key to erase the menus.

FISH ALARM

Use the fish alarm for a distinctive audible alarm when fish or other suspended objects are detected by the Fish I.D. feature. A different tone

sounds for each fish symbol size shown on the display. To turn the fish alarm on, press the ALARM key, then highlight the "Fish Alarm" label and press the right arrow key. The unit will revert to the sonar display with the fish alarm turned on. Repeat the above steps to turn the fish alarm off.

Note: If the unit is in the manual mode, turning the Fish Alarm on will also turn the automatic mode and Fish ID on, also.

ADJUST CHART SURFACE CLARITY

The markings extending downward from the zero line on the chart are called "surface clutter." These markings are caused by wave action, boat wakes, temperature inversion, and other natural causes.

The Surface Clarity Control (SCC) reduces or eliminates surface clutter signals from the display. SCC varies the sensitivity of the receiver, decreasing it near the surface and gradually increasing it as the depth increases. The maximum depth that SCC will affect is 75% of the selected depth range. For example, on a 0-60 foot range with maximum SCC, surface clutter will be reduced down to 45 feet.

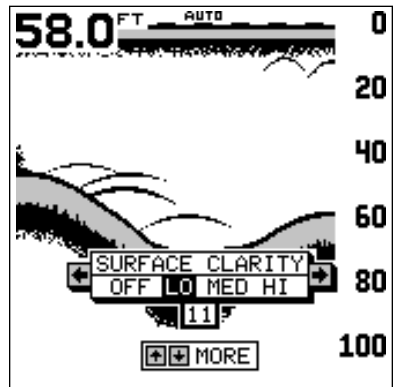

There are three levels of SCC available on the X-65: low, medium, and high. When it's turned on for the first time, the SCC level is low. To change it, press the MENU key, then press the up or down arrow keys until the "Surface Clarity" menu appears. Now use the left or right arrow keys to change it. When you're finished, press the EXIT key to erase the SCC menu.

ASP (Advanced Signal Processing)

The ASP feature is a noise rejection system built into the X-65 that constantly evaluates the effects of boat speed, water conditions, and interference. This automatic feature gives you the best display possible under most conditions.

The ASP feature is an effective tool in combating noise. In sonar terms, noise is any undesired signal. It is caused by electrical and mechanical sources such as bilge pumps, engine ignition systems and wiring, air bubbles passing over the face of the transducer, even vibration from the engine. In all cases, noise can produce unwanted marks on the display.

The ASP feature has two levels - Normal and High. If you have high noise levels, try using the "High" ASP setting. However, if you are having trouble with noise, we suggest that you take steps to find the interference source and fix it, rather than continually using the unit with the high ASP setting. However, there are times when you may want to turn the ASP feature off. This allows you to view all incoming echoes before they are processed by the ASP feature.

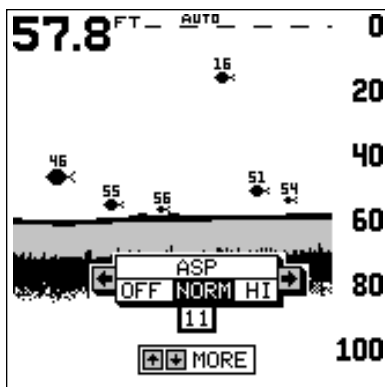

To change the ASP level, press the MENU key then press the up or down arrow keys until the "ASP" menu appears. Now use the left or right arrow keys to change it. When you're finished, press the EXIT key to erase the ASP menu.

SYSTEM SETUP

The following features are available through the "System Setup" menu. To access this menu, press the MENU key, then press the up or down arrow keys until the "System Setup" menu appears. Press the right arrow key. The screen shown at right appears.



Audio/Display

You can adjust the display's contrast and turn the speaker off or on using this menu. To do this, highlight the "Audio/Display" label on the system setup menu, then press the right arrow key. The screen at right appears.

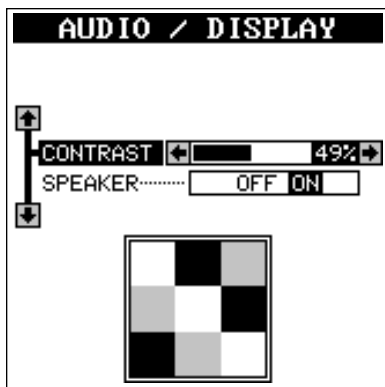

To adjust the contrast, highlight the "Contrast" menu, then use the left or right arrow key to change it. Look at the pattern at the bottom of this screen to adjust the contrast for the best sharpness.

To turn the speaker off, highlight the

"Speaker" label, then press the left arrow key to turn it off.

System Information

This screen shows some basic data about the X-65. To view this, highlight the "System Info" label on the System Setup menu, then press the right arrow key. The system info screen appears. To erase this screen, press the EXIT key. The X-65 returns to the System Setup menu.

Units of Measure

The X-65 normally shows the depth in feet, speed in statute miles per hour, distance in statute miles, and temperature in degrees Fahrenheit. You can change any of these settings using the units of measure menu. To do this, highlight the "Units of Measure" label on the System Setup menu, then press the right arrow key. The screen at right appears. Highlight the item you want to change, then press the right or left arrow key to change it. To erase this screen, press the EXIT key.

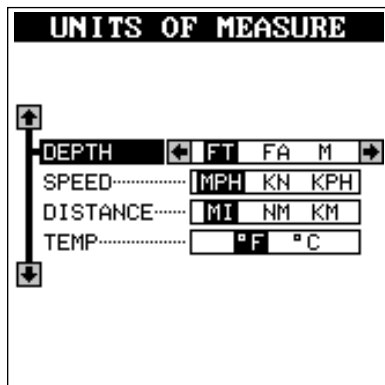

Reset Distance Log

If you have a speed sensor attached to the X-65, the unit starts counting the distance you've travelled each time you turn it on. You can reset this distance to zero by turning the unit off and on again, however, it's easier to highlight the "Reset Distance Log" label on the System Setup menu, then press the right arrow key. This resets the log and keeps you in the System Setup menu. To erase this menu, press the EXIT key.

Temperature Graph

Some of the X-65's screens have a temperature graph, as shown at right. Normally, the temperature graph has a 2° range. On the screen shown at right, the temperature graph has a range from 72° to 74°. You can change this range to 4° or 10° using the "Temp Graph" label on the System Setup menu. Highlight that label, then press the right arrow key until the desired temperature graph range is highlighted. Press the EXIT key to erase the menu.

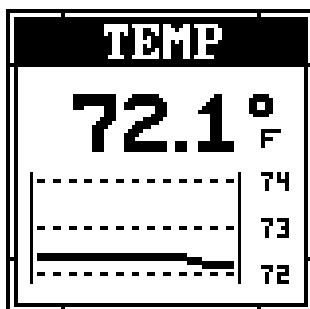

Simulator

The X-65 has a simulator built in that lets you use it as if you are on the water. All features and functions of the unit are usable. A message appears occasionally to remind you that the simulator is on.

To use the simulator, press the MENU key, then press the up or down arrow keys until the "System Setup" menu appears. When it does, press the right arrow key. Now press the up or down arrow keys until the "Simulator" label is highlighted. Finally, press the right arrow key. The X-65 returns to a sonar screen with simulated echoes scrolling across the screen.

Preset Options

The X-65 "remembers" all settings such as units of measure, auto/manual, sensitivity, even when power is removed from the unit. To return the X-65 to the factory settings, highlight the "Preset Options" label on the "System Setup" menu, then press the right arrow key. The X-65 returns to the full chart screen with all settings returned to their factory values.



Keel Offset

The X-65 measures water depth from the face of the transducer. Since the transducer is below the surface of the water, this distance is not the exact water depth. If the transducer is one foot below the surface, and the X-65 reports the water depth as 30 feet, then the depth is actually 31 feet.

You can calibrate the depth reading using the keel offset feature. First, highlight the "Keel Offset" label on the "System Setup" menu, then press the right arrow key. The screen shown at right appears. The current bottom depth shows in the upper left corner of the screen. The keel offset shows in the upper right corner. In this example, we need to change the keel offset so that the X-65 will add one

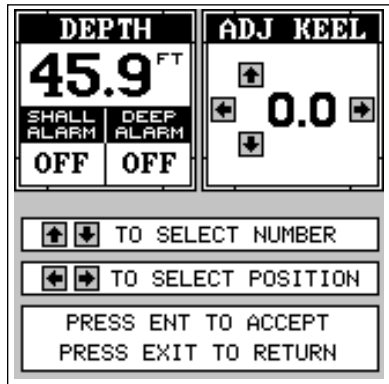

foot to the depth, since the transducer is one foot below the surface. Press the right arrow key, then the up or down arrow keys until 1.0 appears in the "Adj Keel" box, as shown at right, then press the ENT key. This immediately changes the digital depth display at the top of the screen by one foot. Press the EXIT key to erase this menu.

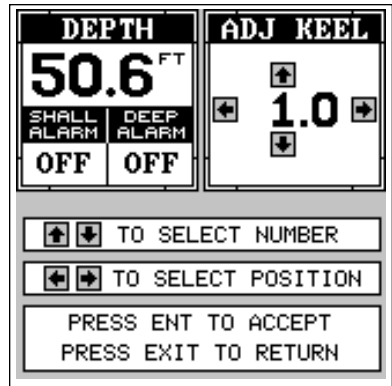

Note: Another way to use the keel offset feature is if you want to know the depth of the water below the lowest part of the boat, instead of the surface. To do this, measure the lowest part of the boat below the transducer. In this example, we'll use 3 feet. Now, using the keel offset feature, adjust the offset for a *negative* 3 feet, as shown at right.

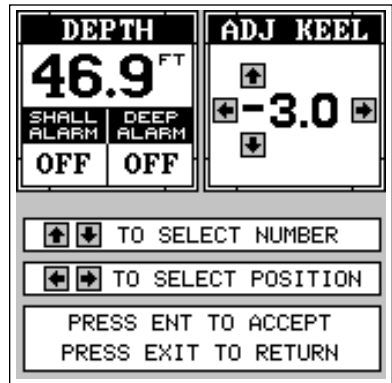

Please note that adjusting the keel offset only affects the digital depth display and all features that use the digital depth, such as the depth alarms and FishTrack. This doesn't affect the chart at all.

Calibrate Speed

You can calibrate the speed display if an optional speed sensor is attached to the X-65. To do this, highlight the "Calibrate Speed" label on the "System Setup" menu, then press the right arrow key. A screen similar to the one at right appears.

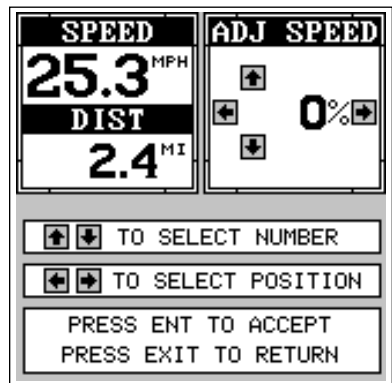

If the digital speed display is slower than your actual speed, add a positive percentage to make it read faster. If the digital speed display is faster, use a negative percentage to make it read slower. Use the arrow keys to change the speed, then press the ENT key. Press the EXIT key to erase this menu.

WINDOWS SUMMARY

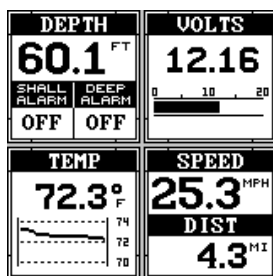

GROUP "A"

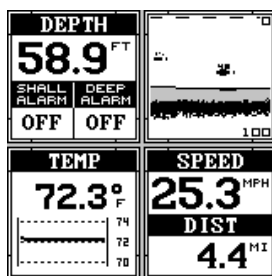

GROUP "B"

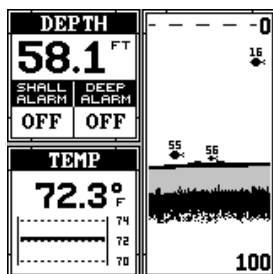

GROUP "C"

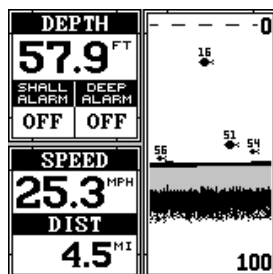

GROUP "D"

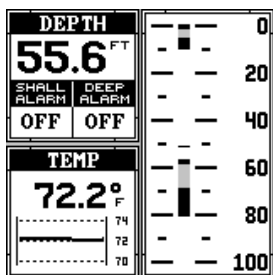

GROUP "E"

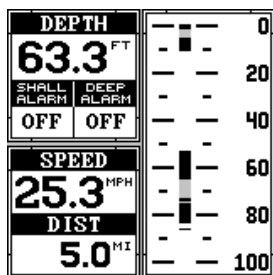

GROUP "F"

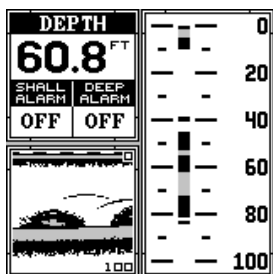

GROUP "G"

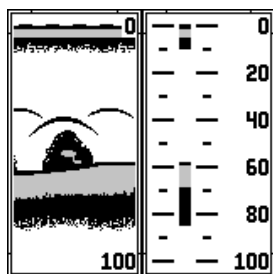

GROUP "H"

TROUBLESHOOTING

If your unit is not working, or if you need technical help, please use the following troubleshooting section before contacting the factory customer service department. It may save you the trouble of returning your unit.

Unit won't turn on:

1. Check the power cable's connection at the unit. Also check the wiring.
2. Make certain the power cable is wired properly. The red wire connects to the positive battery terminal, black to negative or ground.
3. Check the fuse.
4. Measure the battery voltage at the unit's power connector. It should be at least 11 volts. If it isn't, the wiring to the unit is defective, the battery terminals or wiring on the terminals are corroded, or the battery needs charging.

Unit freezes, locks up, or operates erratically:

1. Electrical noise from the boat's motor, trolling motor, or an accessory may be interfering with the sonar unit. Rerouting the power and transducer cables away from other electrical wiring on the boat may help. Route the sonar unit's power cable directly to the battery instead of through a fuse block or ignition switch
2. Inspect the transducer cable for breaks, cuts, or pinched wires.
3. Check both the transducer and power connectors. Make certain both are securely plugged in to the unit.

Weak bottom echo, digital readings erratic, or no fish signals:

1. Make certain transducer is pointing straight down. Clean the face of the transducer. Oil, dirt, and fuel can cause a film to form on the transducer, reducing its effectiveness. If the transducer is mounted inside the hull, be sure it is shooting through only one layer of fiberglass and that it is securely bonded to the hull. Do NOT use RTV silicone rubber adhesive or Marinotex
2. Electrical noise from the boat's motor can interfere with the sonar. This causes the sonar to automatically increase its Discrimination or noise rejection feature. This can cause the unit to eliminate weaker signals such as fish or even structure from the display.

3. The water may be deeper than the sonar's ability to find the bottom. If the sonar can't find the bottom signal while it's in the automatic mode, the digital will flash continuously. It may change the range to limits far greater than the water you are in. If this happens, place the unit in the manual mode, then change the range to a realistic one, (for example, 0-100 feet) and increase the sensitivity. As you move into shallower water, a bottom signal should appear.

4. Check the battery voltage. If the voltage drops, the unit's transmitter power also drops, reducing its ability to find the bottom or targets.

Bottom echo disappears at high speeds or erratic digital reading or weak bottom echo while boat is moving

1. The transducer may be in turbulent water. It must be mounted in a smooth flow of water in order for the sonar to work at all boat speeds. Air bubbles in the water disrupt the sonar signals, interfering with its ability to find the bottom or other targets. The technical term for this is Cavitation.

2. Electrical noise from the boat's motor can interfere with the sonar. This causes the sonar to automatically increase its Discrimination or noise rejection feature. This can cause the unit to eliminate weaker signals such as fish or even structure from the display. Try using resistor spark plugs or routing the sonar unit's power and transducer cables away from other electrical wiring on the boat.

No fish arches when the Fish ID feature is off:

1. Make certain transducer is pointing straight down. This is the most common problem if a partial arch is displayed.

2. The sensitivity may not be high enough. In order for the unit to display a fish arch, it has to be able to receive the fish's echo from the time it enters the cone until it leaves. If the sensitivity is not high enough, the unit shows the fish only when it is in the center of the cone.

3. Use the Zoom feature. It is much easier to display fish arches when zoomed in on a small range of water than a large one. For example, you will have much better luck seeing fish arches with a 30 to 60 foot range than a 0 to 60 foot range. This enlarges the targets, allowing the display to show much more detail.

4. The boat must be moving at a slow trolling speed to see fish arches. If the boat is motionless, fish stay in the cone, showing on the screen as straight horizontal lines.

NOISE

A major cause of sonar problems is electrical noise. This usually appears on the sonar's display as random patterns of dots or lines. In severe cases, it can completely cover the screen with black dots, or cause the unit operate erratically, or not at all.

To eliminate or minimize the effects of electrical noise, first try to determine the cause. With the boat at rest in the water, the first thing you should do is turn all electrical equipment on the boat off. Make certain the engine is off, also. Turn your X-65 on, then turn off ASP (Advanced Signal Processing). There should be a steady bottom signal on the display. Now turn on each piece of electrical equipment on the boat and view the effect on the sonar's display. For example, turn on the bilge pump and view the sonar display for noise. If no noise is present, turn the pump off, then turn on the VHF radio and transmit. Keep doing this until all electrical equipment has been turned on, their effect on the sonar display noted, then turned off.

If you find noise interference from an electrical instrument, trolling motor, pump, or radio, try to isolate the problem. You can usually reroute the sonar unit's power cable and transducer cable away from the wiring that is causing the interference. VHF radio antenna cables radiate noise when transmitting, so be certain to keep the sonar's wires away from it. You may need to route the sonar unit's power cable directly to the battery to isolate it from other wiring on the boat.

If no noise displays on the sonar unit from electrical equipment, then make certain everything except the sonar unit is turned off, then start the engine. Increase the RPM with the gearshift in neutral. If noise appears on the display, the problem could be one of three things; spark plugs, alternator, or tachometer wiring. Try using resistor spark plugs, alternator filters, or routing the sonar unit's power cable away from engine wiring. Again, routing the power cable directly to the battery helps eliminate noise problems. Make certain to use the in-line fuse supplied with the unit when wiring the power cable to the battery.

When no noise appears on the sonar unit after all of the above tests, then the noise source is probably cavitation. Many novices or persons with limited experience make hasty sonar installations which function perfectly in shallow water, or when the boat is at rest. In nearly all cases, the cause of the malfunction will be the location and/or angle of the transducer. The face of the transducer must be placed in a location that has a smooth flow of water at all boat speeds. Read your transducer owner's manual for the best mounting position.

LOWRANCE ELECTRONICS, INC

FULL ONE-YEAR WARRANTY

"We", "our", or "us" refers to LOWRANCE ELECTRONICS, INC, the manufacturer of this product. "You" or "your" refers to the first person who purchases this product as a consumer item for personal, family, or household use.

We warrant this product against defects or malfunctions in materials and workmanship, and against failure to conform to this product's written specifications, all for one year (1) from the date of original purchase by you. **WE MAKE NO OTHER EXPRESS WARRANTY OR REPRESENTATION OF ANY KIND WHATSOEVER CONCERNING THIS PRODUCT.** Your remedies under this warranty will be available so long as you can show in a reasonable manner that any defect or malfunction in materials or workmanship, or any non-conformity with the product's written specifications, occurred within one year from the date of your original purchase, which must be substantiated by a dated sales receipt or sales slip. Any such defect, malfunction, or non-conformity which occurs within one year from your original purchase date will either be repaired without charge or be replaced with a new product identical or reasonably equivalent to this product, at our option, within a reasonable time after our receipt of the product. If such defect, malfunction, or non-conformity remains after a reasonable number of attempts to repair by us, you may elect to obtain without charge a replacement of the product or a refund for the product. **THIS REPAIR, REPLACEMENT, OR REFUND (AS JUST DESCRIBED) IS THE EXCLUSIVE REMEDY AVAILABLE TO YOU AGAINST US FOR ANY DEFECT, MALFUNCTION, OR NON-CONFORMITY CONCERNING THE PRODUCT OR FOR ANY LOSS OR DAMAGE RESULTING FROM ANY OTHER CAUSE WHATSOEVER. WE WILL NOT UNDER ANY CIRCUMSTANCES BE LIABLE TO ANYONE FOR ANY SPECIAL, CONSEQUENTIAL, INCIDENTAL, OR OTHER INDIRECT DAMAGE OF ANY KIND.**

Some states do not allow the exclusion or limitation of incidental or consequential damages, so the above limitations or exclusions may not apply to you.

This warranty does NOT apply in the following circumstances: (1) when the product has been serviced or repaired by anyone other than us, (2) when the product has been connected, installed, combined, altered, adjusted, or handled in a manner other than according to the instructions furnished with the product, (3) when any serial number has been effaced, altered, or removed, or (4) when any defect, problem, loss, or damage has resulted from any accident, misuse, negligence, or carelessness, or from any failure to provide reasonable and necessary maintenance in accordance with the instructions of the owner's manual for the product.

We reserve the right to make changes or improvements in our products from time to time without incurring the obligation to install such improvements or changes on equipment or items previously manufactured.

This warranty gives you specific legal rights and you may also have other rights which may vary from state to state.

REMINDER: You must retain the sales slip or sales receipt proving the date of your original purchase in case warranty service is ever required.

UPS Return Service

Lowrance Electronics and United Parcel Service (UPS) are proud to offer all of our customers free shipping for all units sent to us for repair or service. If you have to send this unit to the factory, and you are in the continental United States, use the enclosed UPS shipping label for easy, free shipping to our factory customer service department. There are six easy steps:

1. Call Lowrance at the toll-free number on the front of this flyer for a Return Authorization (RA) number and instructions about what accessories to return. **Do not return a product to the factory without a Return Authorization (RA) Number!**
2. Pack your unit and any accessories in the original shipping container, if possible. **Be sure to include proof of purchase for warranty verification!**
3. Write a brief note detailing the problem you're having with the unit. Please include your name, address, and daytime telephone number.
4. Please include payment for non-warranty repairs. Check, money order, Visa, or MasterCard may be used.
5. Fill in your name, address, zip code, date, and RA number in the blanks provided on the UPS form included with your unit.
6. Attach the label to the shipping box, tear off the tab for your receipt and give the package to any UPS driver or take the package to any UPS Customer Center. You will not be charged for this shipment.

That's it! Your unit will be shipped to Lowrance's customer service department at no charge to you. Units under warranty will be returned to you at no charge.

NOTE!

Lowrance will pay UPS surface shipping charges both to and from the factory for this unit in the event it needs repair. Your unit is insured against loss or shipping damage when you use the enclosed UPS label.

KEEP THIS LABEL!
**YOU WILL NEED IT IF YOU EVER NEED TO RETURN YOUR UNIT TO THE
FACTORY FOR REPAIR.**

This UPS shipping offer is good only in the continental United States (excludes Alaska and Hawaii).

Lowrance Electronics may find it necessary to change or end our shipping policies, regulations, and special offers at any time. We reserve the right to do so without notice.

Accessory Ordering Information

To order accessories such as power cables or transducers, please contact:

- 1) Your local marine dealer. Most quality dealers that handle marine electronic equipment should be able to assist you with these items. Consult your local telephone directory for listings.
- 2) LEI Extras, Inc. P.O. Box 129 Catoosa, OK 74015-0129
or call
800-324-0045
(USA orders only.)

How to Obtain Service

(Canadian Customers Only)

We back your investment in quality products with quick, expert service and genuine Lowrance replacement parts. If you need service or repairs, contact the Lowrance Factory Customer Service Department at the toll-free number listed below. A technician may be able to solve the problem and save you the inconvenience of returning your unit. You will be asked for your unit's serial number.

800-324-1356

Canada Only. Monday through Friday 8:00 A.M. - 8:00 P.M. Central Time.

How to Obtain Service

(International Customers Only)

If you need service or repairs, contact the dealer in the country you purchased your unit.

**WARRANTY REPAIR WILL BE HONORED ONLY IN THE COUNTRY
UNIT WAS PURCHASED.**

Please follow the shipping instructions shown below on this page if you have to mail your unit to the dealer. For proper testing, repair, and service, send a brief note with the product describing the problem. Be sure to include your name, return shipping address, and a daytime telephone number.

Shipping Information

When sending a product for repair, we recommend you do the following:

1. Always use the original shipping container and filler material the product was packed in when shipping your product.
2. Always insure the parcel against damage or loss during shipment. Lowrance does not assume responsibility for goods lost or damaged in transit.
3. For proper testing, repair, and service, send a brief note with the product describing the problem. Be sure to include your name, return shipping address, and a daytime telephone number.

Accessory Ordering Information

To order accessories such as power cables or transducers, please contact:

1. Your local marine dealer. Most quality dealers that handle marine electronic equipment should be able to assist you with these items. Consult your local telephone directory for listings.
2. Canadian customers only can write:
Lowrance/Lowrance Canada, 919 Matheson Blvd., E. Mississauga, Ontario L4W2R7
or fax 905-629-3118

How to Obtain Service (U.S.A. Only)

We back your investment in quality products with quick, expert service and genuine Lowrance® replacement parts. If you're in the United States and you have questions, please contact the Factory Customer Service Department using our toll-free number listed below. You must send the unit to the factory for warranty service or repair. Please call the factory before sending the unit. You will be asked for your unit's serial number (shown above). Use the following toll-free number:

800-324-1356

U.S.A. only. Monday through Friday 8:00 A.M. - 8:00 P.M. Central time, except holidays.

Your unit is covered by a full one-year warranty. (See page 29 for complete warranty details.) If your unit fails and the failure is not covered by the original warranty, Lowrance has a flat-rate repair policy that covers your unit and accessories packed with the unit at the factory. There is a 180-day warranty on all non-warranty repairs from the factory, which is similar to the original warranty, but is for 180 days rather than one year. For further details, please call us at the above number.

Lowrance also gives you free UPS shipping from anywhere in the continental United States both to and from the factory for all warranty repairs. You can also use the enclosed UPS shipping label for non-warranty shipments. See page 30 for more information.

Remember, non-warranty repairs are subject to Lowrance's published flat-rate charges and 180-day warranty.

LOWRANCE ELECTRONICS, INC
12000 E. SKELLY DRIVE
TULSA, OK 74128