

LCX-104C Fish-finding Sonar & Mapping GPS Operation Instructions

Copyright © 2002 Lowrance Electronics, Inc.
All rights reserved.

Lowrance® is a registered trademark of Lowrance Electronics, Inc.

MapCreate™ is a trademark of Lowrance Electronics, Inc.

Marine-Tex™ is a trademark of Illinois Tool Works Inc.

Navionics® is a registered trademark of Navionics, Inc.



Points of Interest Data in this unit are by infoUSA, copyright © 2001-2002, All Rights Reserved. infoUSA is a trademark of infoUSA, Inc.



eXitSource Database, copyright © 2001-2002 Zenrin Co. Ltd. Exit Authority™ and eXitSource™ are trademarks of Zenrin Co. Ltd.

Lowrance Electronics may find it necessary to change or end our policies, regulations and special offers at any time. We reserve the right to do so without notice. All features and specifications subject to change without notice. All screens in this manual are simulated. On the cover: LCX-104C shown.

**For free owner's manuals and other information,
visit our web site:**

www.lowrance.com

Lowrance Electronics Inc.
12000 E. Skelly Dr.
Tulsa, OK USA 74128-2486
Printed in USA.

Table of Contents

Sec. 1: Read Me First!	1
Capabilities and Specifications: LCX-104C	3
How your Sonar Works	5
How your GPS Works	6
Introduction to GPS and WAAS	8
How to Use this Manual: Typographical Conventions	10
Sec. 2: Installation & Accessories	13
Preparations	13
Transducer Installation	13
Recommended Tools and Supplies	14
Selecting a Transducer Location	14
How Low Should You Go?	15
Shoot-Thru-Hull vs. Transom Mounting	16
Transom Transducer Assembly and Mounting	16
Trolling Motor Bracket Installation	22
Transducer Orientation and Fish Arches	23
Shoot-Thru-Hull Preparation and Installation	23
Speed/Temperature Sensors	26
Sensor Chart	27
Optional Speed Sensor Installation	28
GPS Antenna/Receiver Module	29
Power Connections	30
NMEA/DGPS Cable Connections	31
NMEA/DGPS Wiring	31
Mounting the Unit: Bracket or in-Dash	33
MMC or SDC Memory Card Installation	35
Other Accessories	36
Screen Cleaning Kit	36
MMC and Mapcreate	37
Switch Boxes	37
External Speaker	37
Face Cover	38
Sec. 3: Basic Sonar Operation	39
Keyboard	39
Power/Lights (Turn Unit On and Off)	40
Main Menu	40
Pages	42
Satellite Status Page	42
Navigation Page	43
Map Page	43
Sonar Page	44
LCX-104C Sonar Quick Reference	47

Sonar Operations	48
Fish Symbols vs. Full Sonar Chart	50
Other Free Training Aids	50
Sec. 4: Sonar Options & Other Features	53
ASP™ (Advanced Signal Processing)	53
Alarms	54
Depth Alarms	54
Zone Alarm	55
Fish Alarm.....	56
Calibrate Speed.....	56
Chart Speed.....	57
Colorline™	58
Depth Cursor.....	60
Depth Range - Automatic	60
Depth Range - Manual.....	61
Depth Range - Upper and Lower Limits	61
FasTrack™	63
Fish I.D.™ (Fish Symbols & Depths)	63
FishTrack™	65
Frequency (Change Transducer Frequency)	65
HyperScroll™	66
Log Sonar Chart Data	66
Noise Rejection.....	67
Overlay Data	67
Ping Speed & HyperScroll™	69
to Change Ping Speed:	70
to Adjust Sensitivity:	70
to Turn Off HyperScroll:.....	70
Reset Options	71
Reset Water Distance	71
Set Keel Offset	72
Sensitivity & Auto Sensitivity.....	73
Sonar Color Mode.....	74
Sonar Page & Sonar Chart Display Options	75
Full Sonar Chart	75
Split Zoom Sonar Chart.....	76
Split Frequency Sonar Chart	76
Digital Data/Chart.....	78
FlashGraf™	79
Map with Sonar Split Screen	80
Sonar Simulator	80
Stop Chart.....	83
Surface Clarity	83

Upper and Lower Limits	84
Zoom & Zoom Bar	84
Zoom Pan.....	85
Sec. 5: Sonar Troubleshooting.....	87
Sec. 6: Basic GPS Operations.....	91
Keyboard	91
Power/Lights (Turn Unit On and Off)	92
Main Menu	92
Pages	94
Sonar Page	94
Satellite Status Page	94
Navigation Page.....	96
Map Page.....	98
GPS Quick Reference	103
Find your Current Position	104
Moving around the Map: Zoom & Cursor Arrow Keys.....	104
Selecting any Map Item with the Cursor	105
Searching.....	105
Set a Waypoint.....	107
Create Waypoint at Current Position	107
Create Waypoint on Map.....	108
Create Waypoint by Entering a Position	109
Navigate to a Waypoint	109
Set Man Overboard (MOB) Waypoint.....	110
Navigate Back to MOB Waypoint.....	110
Navigate to Cursor Position on Map.....	111
Navigate to a Point of Interest.....	113
Creating and Saving a Trail.....	113
Displaying a Saved Trail	115
Navigating Trails.....	115
Visual Trailing	116
Navigate a Trail (Forward).....	116
Navigate a Back Trail (Backtrack, or Reverse).....	118
Transfer Custom Maps and GPS Data Files	119
Cancel Navigation.....	121
Sec. 7: Advanced GPS Operations	123
Find Distance from Current Position to Another Location	123
Find Distance from Point to Point	123
Icons.....	123
Create Icon on Map.....	124
Create Icon at Current Position	124
Delete an Icon	124
Navigate to an Icon.....	125

Routes.....	125
Create and Save a Route	126
Delete a Route.....	128
Edit a Route	128
Navigate a Route.....	129
Navigate a Route in Reverse	130
Trails	131
Delete a Trail	131
Edit a Trail Name	131
Edit a Trail Color.....	131
Edit a Trail Pattern	131
Utilities.....	132
Alarm Clock.....	132
Sun/Moon Rise & Set Calculator.....	132
Trip Calculator.....	132
Trip Down Timer.....	132
Trip Up Timer	132
Waypoints.....	132
Delete a Waypoint.....	132
Edit a Waypoint (Name, Symbol, and Position).....	133
Selecting a Waypoint	133
Set a Waypoint by Average Position	133
Set a Waypoint by Projecting a Position.....	134
Sec. 8: System & GPS Setup Options.....	135
Alarms	135
Auto Satellite Search.....	136
Check MMC Files and Storage Space.....	137
Communications Port Configuration	137
Configure DGPS.....	138
Configure NMEA	139
Coordinate System Selection.....	139
To Setup Loran Td:	140
Map Fix	140
Customize Page Displays	142
DGPS Status	142
GPS Simulator	142
Hide GPS Features	144
Initialize GPS.....	144
Map Auto Zoom.....	144
Map Data.....	145
Show Map Data.....	145
Pop-Up Map Info.....	145
Map Boundaries	146

Fill Water with White	146
Map Overlays (Range Rings; Lat/Long Grid)	146
Map Datum Selection	146
Map Detail Category Selection.....	147
Map Orientation	148
Overlay Data	149
Navionics® Charts.....	151
To Display a Navionics Chart:	151
Port Information	152
To View Port Services Information:	152
Tidal Current Information	153
To View Tidal Current Information:	153
Tide Information	155
To View Tide Information:.....	155
Pop-Up Help	156
Position Pinning.....	157
Reset Options	157
Require DGPS	158
Screen Contrast and Brightness	158
Set Language	159
Set Local Time	160
Show WAAS Alarm.....	160
Software Version Information.....	161
Sounds and Alarm Sound Styles.....	161
Track Smoothing.....	162
Trail Options	162
Delete All Trails.....	163
Update Trail Option.....	163
Delete Trail	164
New Trail.....	164
Trail Visible/Invisible and Other Trail Options	164
Units of Measure.....	165
Sec. 9: Searching.....	167
Find Addresses.....	167
Find any Item Selected by Map Cursor	170
Find Interstate Highway Exits	170
Find Map Places or Points of Interest (POI)	173
Find Streets or Intersections.....	174
Find Waypoints.....	177
Sec. 10: Supplemental Material.....	181

WARNING!
A CAREFUL NAVIGATOR NEVER RELIES ON ONLY ONE METHOD TO OBTAIN POSITION INFORMATION.

CAUTION

When showing navigation data to a position (waypoint), a GPS unit will show the shortest, most direct path to the waypoint. It provides navigation data to the waypoint regardless of obstructions. Therefore, the prudent navigator will not only take advantage of all available navigation tools when traveling to a waypoint, but will also visually check to make sure a clear, safe path to the waypoint is always available.

WARNING!

When a GPS unit is used in a vehicle, the vehicle operator is solely responsible for operating the vehicle in a safe manner. Vehicle operators must maintain full surveillance of all pertinent driving, boating or flying conditions at all times. An accident or collision resulting in damage to property, personal injury or death could occur if the operator of a GPS-equipped vehicle fails to pay full attention to travel conditions and vehicle operation while the vehicle is in motion.

Section 1:

Read Me First!

How this manual can get you out on the road, fast!

Welcome to the exciting world of digital sonar and GPS! We know you're anxious to begin navigating and finding fish, but we have a favor to ask. Before you grab the unit and begin installing it, please give us a moment or two to explain how our manual can help you get the best performance from your commercial-quality combination fish finder and mapping GPS receiver.

First, we want to thank you for buying a Lowrance sonar/GPS unit. Whether you're a first time user or a professional fisherman, you'll discover that your unit is easy to use, yet capable of handling demanding navigation and sonar tasks. When you team your unit with our custom mapping software MapCreate™ 6, you have an incredible combination. With a full VGA color display, recording capability and remarkable resolution, you won't find another GPS/sonar unit with this much power and this many features for this price!

Our goal for this book is to get you on the water fast, with a minimum of fuss. Like you, we'd rather spend more time boating or fishing and less time reading the manual!

So, we designed our book so that you *don't* have to read the *whole thing* from front to back for the information you want. At the start (or end) of each segment, we'll tell you what content is coming up next. If it's a concept you're already familiar with, we'll show you how and where to skip ahead for the next important topic. We've also made it easy to look up any tips you may need from time to time. Here's how:

The manual is organized into 10 sections. This first section is an introduction to the LCX-104C sonar and GPS. It tells you the basics you need to know before you can make the unit look around and tell you where you are, or look below the surface to find some fish.

Section 2 will help you install your unit, the transducer and the GPS antenna module. We'll show you how to get the MultiMedia Card (MMC) correctly installed inside the unit. We'll also tell you about some of the available accessories.

Section 3 covers *Basic Sonar Operation*. It will show you how easy it is to run your sonar, right out of the box. This section features a one-page Sonar Quick Reference. **(If you've already jumped ahead and figured out how to install the unit yourself, and you just *can't* wait any longer, turn to the Quick Reference on page 47 and head for the water with your unit!)**

After you've gained some experience with your sonar, you'll want to check out Section 4, which discusses more advanced *Sonar Options and Other Features*.

When you come to a sonar menu command on the unit's screen, you can look it up in the manual by skimming over the table of contents, just flipping through Section 3 or scanning through the sonar options in Section 4.

If you're having difficulty with your sonar, you can find an answer to the most common problems in Section 5, *Sonar Troubleshooting*.

The manual switches from sonar to navigation in Section 6, which introduces you to *Basic GPS Operations*. **This section features a one-page GPS Quick Reference on page 103.**

Section 6 contains short, easy-to-scan GPS lessons that follow one another in chronological order. They're all you'll need to know to find your way on the water quickly.

After you've learned the basics (or if you already have some GPS experience), you may want to try out some of the unit's many advanced navigation features. That brings us to Section 7, *Advanced GPS Operations*. This section contains the rest of the unit's GPS command functions, organized in alphabetical order.

When you come to a GPS menu command on the screen, you can look it up in the manual by skimming over the table of contents, just flipping through Section 6 or scanning through the command portion of Section 7.

This unit is ready to use right out of the box, but you can fine tune and customize its operation with dozens of options. Since sonar is the unit's key feature, we put the main sonar options in Section 4. Some options, such as screen brightness settings, affect both sonar and GPS operations. We describe how to use those common options along with GPS options in Section 8, *System Setup and GPS Setup Options*. Section 8 is organized in alphabetical order.

In Section 9, we go into more detail on one of the unit's most remarkable GPS capabilities — Searching. We'll introduce a search example in the Basic GPS Operation section, but there are so many map items you can search for, we had to give this function its own section in the manual! For example, did you know your unit can look up business phone numbers, functioning as a virtual Yellow Pages? We'll show you how in Section 9.

Finally, in Section 10, we offer *Supplemental Material*, including a list of the GPS datums used, warranties and customer service information. Now, if you're into the fine details, glance over the next segment on specifications to see just how much sonar and GPS power your unit contains. It's important to *us* (and our power users), but, if *you* don't care

how many watts of power the unit has, or how many waypoints it can store, skip ahead to important information on how sonar works, on page 5. (Background on GPS begins on page 6.)

Capabilities and Specifications: LCX-104C

General

- Display:**..... High-brightness liquid crystal TFT; programmable to viewing preference; 10.4" (26.4 cm) diagonal. Multiple full-screen and split-screen data display combinations.
- Resolution:**..... 640 pixel x 480 pixel resolution; 307,200 total pixels; 256-color, full VGA.
- Backlighting:**..... Fluorescent cold cathode backlit screen with multiple lighting levels; backlit keypad.
- Input power:**..... 10 to 15 volts DC.
- Current drain:** Sonar only: 700 ma lights off; 1.2 amps lights on. With GPS and lights on: 1.3 amps.
- Case size:**..... (with bracket) 9.1" H x 12.2" W x 4" D (23.1 x 31 x 10.2 cm); sealed and waterproof; suitable for saltwater use.
- MMC slots:** Two in waterproof compartments (SD card compatible).
- Back-up memory:** Built-in memory stores sonar records and GPS data for decades. User settings are stored when unit is turned off.
- Languages:**..... 10; menu languages selectable by user.
- External speaker:**..... speaker wires allow connection to external speaker for remotely monitoring sonar and GPS alarms.

Sonar

- Frequency:**..... 50/200 kHz dual-frequency.
- Transducer:**..... Skimmer[®] transducer with built-in temperature sensor available. Dual-frequency transducer with 35°/12° cone angles; operates at speeds up to 70 mph (61 kts). Optional thru-hull, shoot-thru-hull and trolling motor transducers are available.
- Transmitter:** **50 kHz:** 8,000 watts peak-to-peak/1 kW RMS. **200 kHz:** 4,000 watts peak-to-peak/500 watts RMS.

Sonar sounding

depth capability: 3,000 feet (915 meters). Actual capability depends on transducer configuration and installation, bottom composition and water conditions. All sonar units typically read deeper in fresh water than in salt water.

Depth display:..... Continuous display.

Graph recording:..... Up to 512 MB on two MMC (or SD) cards

Audible alarms: Deep/shallow/fish/zone.

Automatic ranging:..... Yes, with instant screen updates.

Auto bottom track:..... Yes

Zoom bottom track: Yes.

Split-screen zoom:..... Yes.

Surface water temp: Yes, built into transducer. Optional additional temp sensors for live well, bait well, etc. are available.

Speed/distance log: Yes; speed sensor is included with unit.

GPS

Receiver/antenna: External; LGC-12w 12 parallel channel GPS/WAAS; DGPS beacon receiver optional. The unit interfaces NMEA 0183.

Recording:..... MMC & SD memory cards for recording GPS trip details and displaying charts or custom maps.

Background map:..... Built-in custom, detailed Lowrance map. Contains: enhanced detail of continental U.S. and Hawaii. Includes more than 60,000 nav aids and 10,000 wrecks/obstructions in coastal and Great Lakes waters. Metro areas, selected major streets/highways and interstate exit services details included.

Custom mapping: MapCreate™ version 6 software optional; featuring unit-searchable database of more than 700,000 points of interest. Navionics® charts (XL charts or HotMaps™) on MMC cards optional.

Mapping memory: Up to 512 MB on two MMC (or SD) cards.

- Position updates:** Every second.
- Position points:** 1,000 waypoints; 1,000 event marker icons.
- Man Overboard:**..... MOB feature precisely marks man overboard location with special icon, then automatically displays navigation data to that position.
- Audible alarms:** Arrival/off-course/destination passed/anchor.
- Graphic symbols for waypoints or event marker icons:** 42.
- Routes:**..... 100; up to 100 waypoints per route.
- Plot Trails:**..... 10 savable; up to 9,999 points per trail.
- Zoom range:**..... 37 ranges; 0.05 to 4,000 miles.

NOTE:

The above memory capacities refer only to the unit's on-board memory. The amount of GPS or sonar data you can record and save for recall later is only limited by the number of MMC cards you have.

NOTICE!

The storage and operation temperature range for your unit is from -4 degrees to +167 degrees Fahrenheit (-20 degrees to +75 degrees Celsius). *Extended storage or operation in temperatures higher or lower than specified will damage the liquid crystal display in your unit. This type of damage is not covered by the warranty.* For more information, contact the factory's Customer Service Department; phone numbers are listed on the last page.

How Your Sonar Works

Sonar has been around since the 1940s, so if you already know how it works, skip down to read about the relatively new technology of GPS. But, if you've never owned a sonar fish finder, this segment will tell you the underwater basics.

Sonar is an abbreviation for Sound Navigation and Ranging, a technology developed during World War II for tracking enemy submarines. (Lowrance developed the world's *first* transistorized *sportfishing* sonar in 1957.) A sonar consists of a transmitter, transducer, receiver and display. In simple terms, here's how it finds the bottom, or the fish:

The transmitter emits an electrical impulse, which the transducer converts into a sound wave and sends into the water. (The sound frequency can't be heard by humans or fish.) The sound wave strikes an object

(fish, structure, bottom) and bounces back to the transducer, which converts the sound back into an electrical signal.

The receiver amplifies this return signal, or echo, and sends it to the display, where an image of the object appears on the scrolling sonar chart. The sonar's microprocessor calculates the time lapse between the transmitted signal and echo return to determine the distance to the object. The whole process repeats itself several times each second.

Your sonar unit can record a log of the sonar signals that scroll across the screen and save them to the MMC memory card. (These recordings are also called sonar charts or sonar graphs.) You can replay this sonar log in the unit using the Sonar Simulator function, or play it back on a personal computer using our free Sonar Viewer. The viewer is available for download from the Lowrance web site, www.lowrance.com.

You can save several different sonar log files, erase 'em and record new ones, over and over again. The size of your sonar recordings is only limited by the free space available on your MMC.

How Your GPS Works

You'll navigate faster and easier if you understand how this unit scans the sky to tell you where you are on the earth — and, where you're going. (But if you already have a working understanding of GPS receivers and the GPS navigation system, skip on ahead to Section 2, *Installation & Accessories* on page 13. If you're new to GPS, read on, and you can later impress your friends with your new-found knowledge.)

First, think of your unit as a small but powerful computer. (But don't worry — we made the series easy to use, so you don't need to be a computer expert to find your way!) The unit includes a keypad and a screen with menus so you can tell it what to do. The screen also lets the unit show your location on a moving map, as well as point the way to your destination.

This gimbal-mounted unit uses an external antenna/receiver module, which makes the whole system work something like your car radio. But instead of your favorite dance tunes, this receiver tunes in to a couple of dozen GPS satellites circling the earth. (It will also listen in to the WAAS satellites in orbit, but more about that in the upcoming segment introducing you to GPS and WAAS.)

Your unit listens to signals from as many satellites as it can "see" above the horizon, eliminates the weakest signals, then computes its location in relation to those satellites. Once it figures its latitude and longitude, the unit plots that position on the moving map shown on the screen. The whole process takes place several times a second!

The performance doesn't stop there. Stored in the permanent memory of every unit is a basic background map of the *entire* world. We lock it in here at the factory — you can't change or erase this map.

The background map is suitable for many navigation chores, but for maximum accuracy and much more detail, you need our optional map-making software, MapCreate™ 6. Some unit features — such as searching for businesses and addresses — won't work without a custom MapCreate map. There is so much detail in our background map (and even more in MapCreate) that we'll describe their contents and differences in Section 6, *Basic GPS Operations*, on page 91.

Another portion of the unit's onboard memory is devoted to *recording* GPS navigation information, which includes waypoints, event marker icons, trails and routes. This lets you look back the way you came. Think of this data storage like the hard drive memory in a computer or a tape in a cassette tape recorder. You can save several different GPS data files, erase 'em and record new ones, over and over again. Like any computer file, these **GPS Data Files** (file format *.usr) can be shared between other Lowrance GPS or sonar/GPS units and even personal computers.

Your unit has one more thing in common with a personal computer. Just as computers have a floppy disk drive for storing and exchanging files, this unit has a slot for an MMC (MultiMedia Card) or SDC (Secure Digital card) flash memory card. These solid-state memory devices are about the size of a postage stamp, but can hold data ranging from 8 MB to 256 MB in size. (Compare that to a floppy disk's 1.44 MB capacity!) The unit uses all that MMC space for two key GPS purposes. (The MMC is also used to record sonar logs...see page 6.)

First, you can backup your onboard GPS Data Files by copying them to the MMC. Since the MMC is removable (like a floppy disk or a cassette tape), you can store these GPS Data Files on a personal computer equipped with an MMC card reader. (Or store them on a pocketful of MMCs, if you don't have a computer.) Our MapCreate mapping software can save, edit or create its own GPS Data Files, which can be copied to the MMC and then loaded from the MMC into the unit's memory. (**NOTE:** No matter where they come from, GPS Data Files *must* be loaded from the MMC into memory before the unit can use them.)

The other key GPS use for MMCs is storage of special high-detail, custom maps, which you can produce on your computer with our MapCreate software. These MapCreate custom maps contain much greater detail than the basic background map. These **Custom Map Files** (file format *.lcm) can also be shared between other Lowrance GPS or sonar/GPS units and personal computers. (For example, the exact same

MMC, custom map files and GPS data files can be used interchangeably between your gimbal-mounted LCX-104C and the hand-held iFINDER™ GPS receiver.)

The unit automatically reads Custom Map Files directly from the MMC or SDC. To use a custom map, all you need to do is slide an MMC containing a map into the unit.

Introduction to GPS and WAAS

Well, now you know the basics of how the unit does its work. You might be ready to jump ahead to Section 2, *Installation & Accessories*, on page 13, so you can mount your unit and plug in the power. Or you might want to see how our text formatting makes the manual tutorials easy to skim. If that's the case, move on to "How to Use This Manual" on page 10. But, if you want to understand the current state of satellite navigation, look over this segment describing how GPS and its new companion WAAS work together to get you where you're going.

The Global Positioning System (GPS) was launched July 17, 1995 by the United States Department of Defense. It was designed as a 24-hour-a-day, 365-days-a-year, all weather global navigation system for the armed forces of the U.S. and its allies. Civilian use was also available at first, but it was less accurate because the military scrambled the signal somewhat, using a process called Selective Availability (SA.)

GPS proved so useful for civilian navigation that the federal government discontinued SA on May 2, 2000, after the military developed other methods to deny GPS service to enemy forces. Reliable accuracy for civilian users jumped from 100 meters (330 feet) under SA to the present level of 10 to 20 meters (about 30 to 60 feet.)

Twenty-four satellites orbit 10,900 nautical miles above the Earth, passing overhead twice daily. A series of ground stations (with precisely surveyed locations) controls the satellites and monitors their exact locations in the sky. Each satellite broadcasts a low-power signal that identifies the satellite and its position above the earth. Three of these satellites are spares, unused until needed. The rest virtually guarantee that at least four satellites are in view nearly anywhere on Earth at all times.

The system requires signal reception from three satellites in order to determine a position. This is called a 2D fix. It takes four satellites to determine both position and elevation (your height above sea level — also called altitude). This is called a 3D fix.

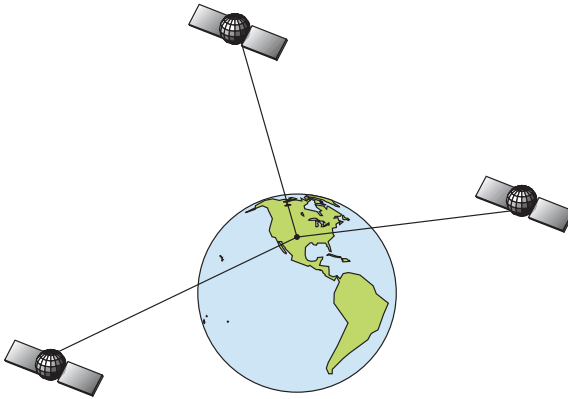

A minimum of three satellites are required to determine a 2D fix.

Remember, the unit must have a clear view of the satellites in order to receive their signals. Unlike radio or television signals, GPS works at very high frequencies. These signals can be easily blocked by trees, buildings, an automobile roof, even your body.

Like most GPS receivers, this unit doesn't have a compass or any other navigation aid built inside. It relies solely on the signals from the satellites to calculate a position. Speed, direction of travel, and distance are all calculated from position information. Therefore, in order for the unit to determine direction of travel, you must be moving and the faster, the better. This is not to say that it won't work at walking or trolling speeds — it will. There will simply be more "wandering" of the data shown on the display.

GPS is plenty accurate for route navigation, but the U.S. Federal Aviation Administration has special needs for aircraft traffic control that go beyond basic GPS. The FAA has a plan under way to boost GPS performance even further with its Wide Area Augmentation System, or WAAS. This GPS add-on will include a time control element that will help airliners fly closer together while avoiding collisions. In addition to carefully spacing airplanes along travel corridors, WAAS will eventually make instrument landings and takeoffs more accurate as it replaces existing aviation navigation systems.

Non-aviators can use WAAS signals to make their GPS navigation even more accurate. Your unit receives both GPS and WAAS signals. However, WAAS has some limits you should know about.

First, the U.S. government has not completed construction of the WAAS system, so it is not yet fully operational. The ground stations are in place, but only a few of the needed WAAS satellites have been launched.

WAAS *can* boost the accuracy of land GPS navigation, but the system is designed for aircraft. The satellites are in a fixed orbit around the Equator, so they appear very low in the sky to someone on the ground in North America. Aircraft and vessels on open water can get consistently good WAAS reception, but terrain, foliage or even large man-made structures frequently block the WAAS signal from ground receivers.

You'll find that using your GPS receiver is both easy and amazingly accurate. It's easily the most accurate method of electronic navigation available to the general public today. Remember, however, that this receiver is only a tool. Always have another method of navigation available, such as a map or chart and a compass.

Also remember that this unit will always show navigation information in the shortest line from your present position to a waypoint, regardless of terrain! It only calculates position, it can't know what's between you and your destination, for example. It's up to you to safely navigate around obstacles, no matter how you're using this product.

How to use this manual: typographical conventions

Many instructions are listed as numbered steps. The keypad and arrow "keystrokes" appear as boldface type. So, if you're in a real hurry (or just need a reminder), you can skim the instructions and pick out what menu command to use by finding the boldface command text. The following paragraphs explain how to interpret the text formatting for those commands and other instructions:

Arrow Keys

The arrow keys control the movement of dotted cross-hair lines on your mapping screen called the cursor. The arrow keys also control a horizontal line depth cursor on the sonar screen. The arrow keys help you move around the menus so you can execute different commands. They are represented by symbols like these, which denote the down arrow key, the up arrow, the left arrow and the right arrow: ↓ ↑ ← →.

Keyboard

The other keys perform a variety of functions. When the text refers to a key to press, the key is shown in bold, sans serif type. For example, the "Enter/Icons" key is shown as **ENT** and the "Menu" key is shown as **MENU**.

Menu Commands

A menu command or a menu option will appear in small capital letters, in a bold sans serif type like this: **ROUTE PLANNING**. These indicate that you are to select this command or option from a menu or take an action of some kind with the menu item. Text that you may need to enter or file names you need to select are show in italic type, such as *trail name*.

Instructions = Menu Sequences

Most functions you perform with this unit are described as a sequence of key strokes and selecting menu commands. We've written them in a condensed manner for quick and easy reading.

For example, instructions for navigating a trail would look like this:

1. From the Map Page, press **MENU | MENU | ↓ to MY TRAILS | ENT**.
2. Press ↓ to *Trail 1* | **ENT** | → | ↓ to **NAVIGATE | ENT**.
3. You are asked to wait while it converts the trail into a route.
4. The wait message disappears and the unit begins showing navigation information along the trail. Now, begin moving and follow your unit's directions.

Translated into complete English, step 1 above would mean: "Start on the Map Page. Press the Menu key twice. Next, repeatedly press (or press and hold) the down arrow key to scroll down the menu and select (highlight) the My Trails menu command. Finally, press the Enter key."

Step 2 would mean: "Press the down arrow key repeatedly to scroll to the trail named Trail 1, and press Enter. Next, press the right arrow key and then the down arrow key to highlight the Navigate command, then press Enter."

Notes

Section 2: Installation & Accessories

Preparations

You can install the sonar and GPS systems in some other order if you prefer, but we recommend this installation sequence:

CAUTION:

You should read over this entire installation section before drilling any holes in your vehicle or vessel!

1. Determine the approximate location for the sonar/GPS unit, so you can plan how and where to route the cables for the antenna, transducer and power. This will help you make sure you have enough cable length for the desired configuration.
2. Determine the approximate location for the transducer and its cable route.
3. Determine the approximate location for the GPS antenna module and its cable route.
4. Determine the location of your battery or other power connection, along with the power cable route.
5. Install the transducer and route the transducer cable to the sonar/GPS unit.
6. Install the GPS antenna and route the antenna cable to the sonar/GPS unit.
7. Install the power cable and route it to the sonar/GPS unit.
8. Mount the sonar/GPS unit.

Transducer Installation

These instructions will help you install your Skimmer[®] transducer on a transom, on a trolling motor or inside a hull. These instructions cover both single- and dual-frequency Skimmer transducers. Please read all instructions before proceeding with any installation.

The smaller single-frequency Skimmers typically use a one-piece, stainless steel mounting bracket. The larger dual-frequency Skimmers typically use a two-piece, plastic mounting bracket. The trolling motor mount uses a one-piece plastic bracket with an adjustable strap.

These are all "kick-up" mounting brackets. They help prevent damage if the transducer strikes an object while the boat is moving. If the transducer does "kick-up," the bracket can easily be pushed back into place without tools.

Read these instructions carefully *before* attempting the installation. Determine which of the mounting positions is right for your boat. Use extreme care if mounting the transducer inside the hull, because once it is epoxied into position, the transducer usually cannot be removed. ***Remember, the transducer installation is the most critical part of a sonar installation.***

Recommended Tools and supplies

If you prefer the option of routing the cable through the transom, you will need a 1" drill bit. A transom mount requires use of a *high quality, marine grade* above- or below-waterline caulking compound. The following installation types also call for these recommended tools and required supplies (supplies are *not* included):

Single-frequency transom installations

Tools include: two adjustable wrenches, drill, #29 (0.136") drill bit, flat-head screwdriver. Supplies: none.

Dual-frequency transom installations

Tools: two adjustable wrenches, drill, #20 (0.161") drill bit, flat-head screwdriver. Supplies: four, 1" long, #12 stainless steel slotted wood screws.

Single-frequency trolling motor installations

Tools: two adjustable wrenches, flat-head screwdriver. Supplies: plastic cable ties.

Shoot-through hull installations

Tools: these will vary depending on your hull's composition. Consult your boat dealer or manufacturer. Supplies: 100 grit sandpaper, good quality epoxy adhesive.

Selecting a Transducer Location

1. The transducer must be placed in a location that has a smooth flow of water at all times. If the transducer is to be mounted inside the hull, then the chosen location must be in the water at all times. If the transducer is not placed in a smooth flow of water, interference caused by bubbles and turbulence will show on the sonar's display in the form of random lines or dots whenever the boat is moving.

NOTE:

Some aluminum boats with strakes or ribs on the outside of the hull create large amounts of turbulence at high speed. These boats typically have large outboard motors capable of propelling the boat at speeds faster than 35 mph. Typically, a good location on aluminum boats is between the ribs closest to the engine.

2. The transducer should be installed with its face pointing straight down, if possible.
3. If the transducer is mounted on the transom, make sure it doesn't interfere with the trailer or hauling of the boat. Also, don't mount it closer than approximately one foot from the engine's lower unit. This will prevent cavitation (bubble) interference with propeller operation.
4. If possible, route the transducer cable away from other wiring on the boat. Electrical noise from engine wiring, bilge pumps and aerators can be displayed on the sonar's screen. Use caution when routing the transducer cable around these wires.

CAUTION: Clamp the transducer cable to transom near the transducer. This will help prevent the transducer from entering the boat if it is knocked off at high speed.

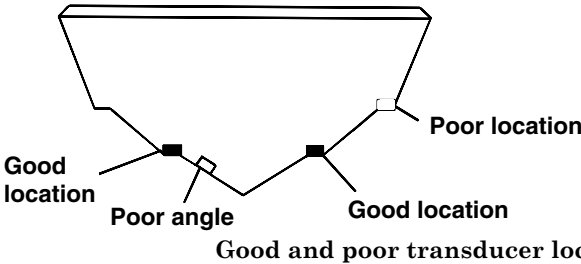
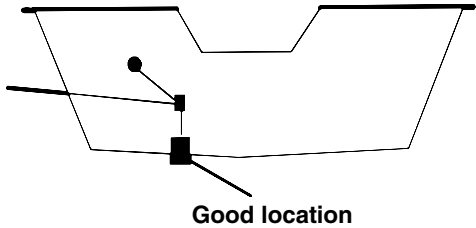

Good and poor transducer locations.

How low should you go?

For most situations, you should install your Skimmer transducer so that its centerline is level with the bottom of the boat hull. This will usually give you the best combination of smooth water flow and protection from bangs and bumps.

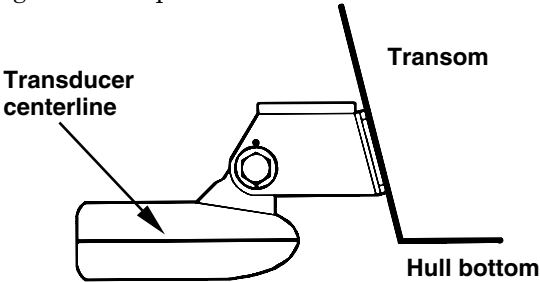

Align transducer centerline with hull bottom.

However, there are times when you may need to adjust the transducer slightly higher or lower. (The slots in the mounting brackets allow you to loosen the screws and slide the transducer up or down.) If you frequently lose bottom signal lock while running at high speed, the transducer may be coming out of the water as you cross waves or wakes. Move the transducer a little lower to help prevent this.

If you cruise or fish around lots of structure and cover, your transducer may be frequently kicking up from object strikes. If you wish, you may move the transducer a little higher for more protection.

There are two extremes you should avoid. Never let the edge of the mounting bracket extend below the bottom of the hull. Never let the bottom – the face – of the transducer rise above the bottom of the hull.

Shoot-thru-hull vs. Transom Mounting

Typically, shoot-thru-hull installations give excellent high speed operation and good to excellent depth capability. There is no possibility of damage from floating objects. It can't be knocked off when docking or loading on the trailer.

However, the shoot-thru-hull installation does have its drawbacks. First, some loss of sensitivity does occur, even on the best hulls. This varies from hull to hull, even from different installations on the same hull. This is caused by differences in hull lay-up and construction.

Second, the transducer angle cannot be adjusted for the best fish arches. This can be a problem on some hulls that sit with the bow high when at rest or at slow trolling speeds. Follow the procedure listed in the shoot-thru-hull installation section at the end of this lesson to determine if you can satisfactorily shoot through the hull.

TRANSOM TRANSDUCER ASSEMBLY AND MOUNTING

The best way to install these transducers is to loosely assemble all of the parts first, place the transducer's bracket against the transom and see if you can move the transducer so that it's parallel with the ground.

The following instructions sometimes vary depending on the mounting bracket that came with your transducer. Single-frequency Skimmers come with a one-piece stainless steel bracket, while dual-frequency Skimmers come with a two-piece plastic mounting bracket. Use the set of instructions that fits your model.

1. Assembling the bracket.

A. One-piece bracket: Press the two small plastic ratchets into the sides of the metal bracket as shown in the following illustration. Notice there are letters molded into each ratchet. Place each ratchet into the

bracket with the letter "A" aligned with the dot stamped into the metal bracket. This position sets the transducer's coarse angle adjustment for a 14° transom. Most outboard and stern-drive transoms have a 14° angle.

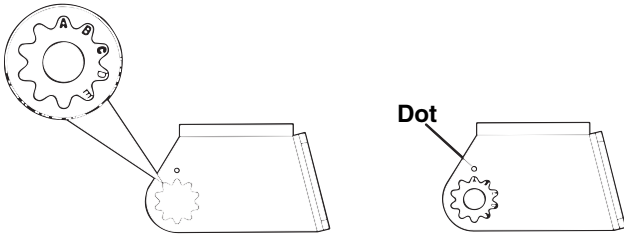

Align plastic ratchets in bracket.

B. Two-piece bracket: Locate the four plastic ratchets in the transducer's hardware package. Press two ratchets into the sides of the plastic bracket and two on either side of the transducer as shown in the following illustrations. Notice there are letters molded into each ratchet.

Place the ratchets into the bracket with the letter "A" aligned with the alignment mark molded into the bracket. Place the ratchets onto the transducer with the letter "A" aligned with the 12 o'clock position on the transducer stem. These positions set the transducer's coarse angle adjustment for a 14° transom. Most outboard and stern-drive transoms have a 14° angle.

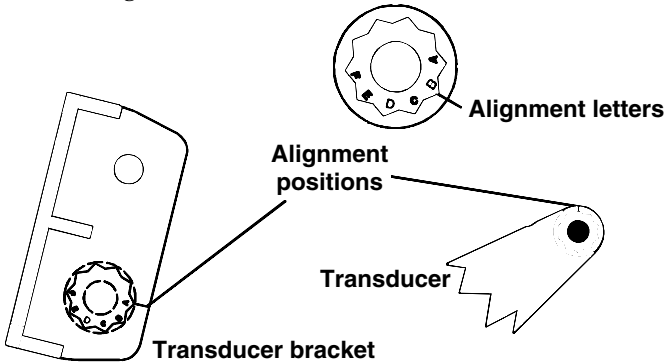

Insert and align ratchets.

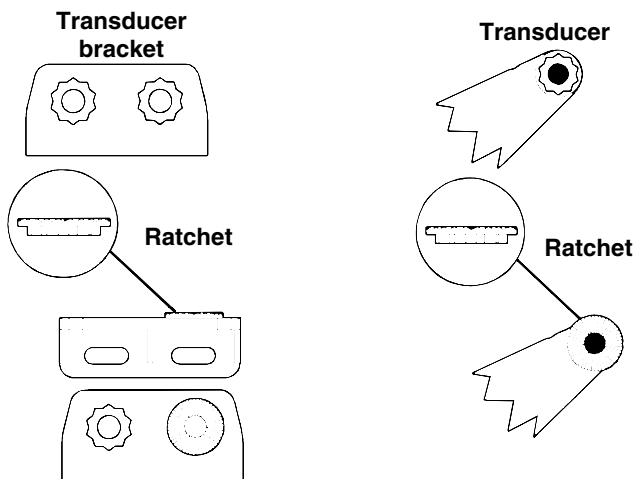

Add ratchets to bracket and transducer.

2. Aligning the transducer on the transom.

A. One-piece bracket: Slide the transducer between the two ratchets. Temporarily slide the bolt through the transducer assembly and hold it against the transom. Looking at the transducer from the side, check to see if it will adjust so that its face is parallel to the ground. If it does, then the "A" position is correct for your hull.

If the transducer's face isn't parallel with the ground, remove the transducer and ratchets from the bracket. Place the ratchets into the holes in the bracket with the letter "B" aligned with the dot stamped in the bracket.

Reassemble the transducer and bracket and place them against the transom. Again, check to see if you can move the transducer so it's parallel with the ground. If you can, then go to step 3A. If it doesn't, repeat step 2A, but use a different alignment letter until you can place the transducer on the transom correctly.

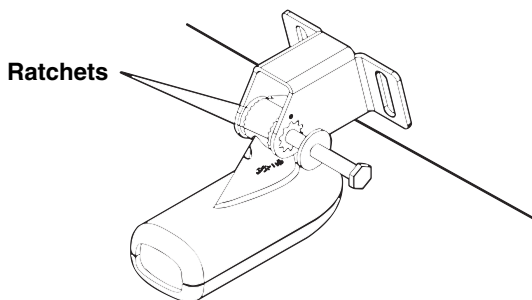

Insert bolt and check transducer position on transom.

B. Two-piece bracket: Assemble the transducer and bracket as shown in the following figure. Temporarily slide the bolt through the transducer assembly but don't tighten the nut at this time. Hold the assembled transducer and bracket against the transom. Looking at the transducer from the side, check to see if it will adjust so that its face is parallel to the ground. If it does, then the "A" positions are correct for your hull.

If the transducer's face isn't parallel with the ground, remove and disassemble the transducer and ratchets. Place the ratchets into the bracket holes with the letter "B" aligned with the bracket alignment mark. Place them on the transducer aligned with the 12 o'clock position on the transducer stem.

Reassemble the transducer and bracket and place them against the transom. Again, check to see if you can move the transducer so it's parallel with the ground. If you can, then go to step 3B. If it doesn't, repeat step 2B, but use a different alignment letter until you can place the transducer on the transom correctly.

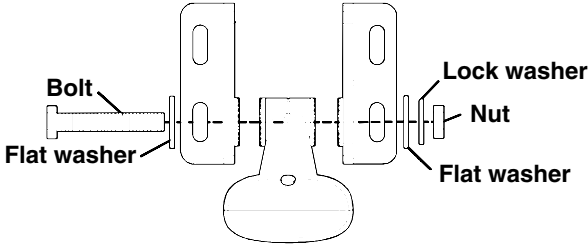

Assemble transducer and bracket.

3. Assembling the transducer.

A. One-piece bracket: Once you determine the correct position for the ratchets, assemble the transducer as shown in the following figure. Don't tighten the lock nut at this time.

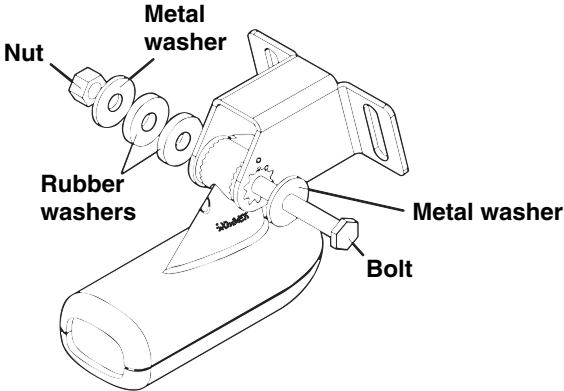

Assemble transducer and bracket.

B. Two-piece bracket: Once you determine the correct position for the ratchets, assemble the transducer as shown in the figure in step 2B. Don't tighten the lock nut at this time.

4. Drilling mounting holes.

Hold the transducer and bracket assembly against the transom. The transducer should be roughly parallel to the ground. The transducer's centerline should be in line with the bottom of the hull. Don't let the bracket extend below the hull!

Mark the center of each slot for the mounting screw pilot holes. You will drill one hole in the center of each slot.

Drill the holes. For the one-piece bracket, use the #29 bit (for the #10 screws). For the two-piece bracket, use the #20 bit (for the #12 screws).

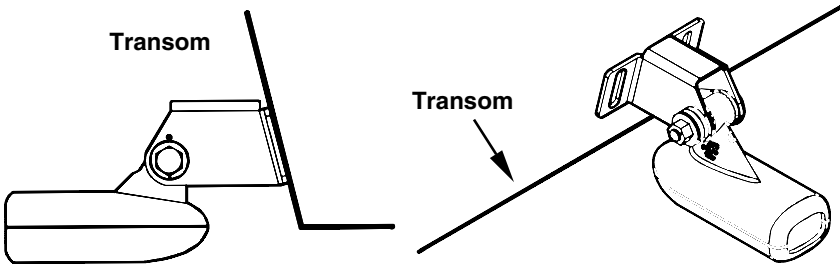

Position transducer mount on transom and mark mounting holes.
Side view shown at left and seen from above at right.

5. Attaching transducer to transom.

A. One-piece bracket: Remove the transducer from the bracket and re-assemble it with the cable passing through the bracket over the bolt as shown in the following figures.

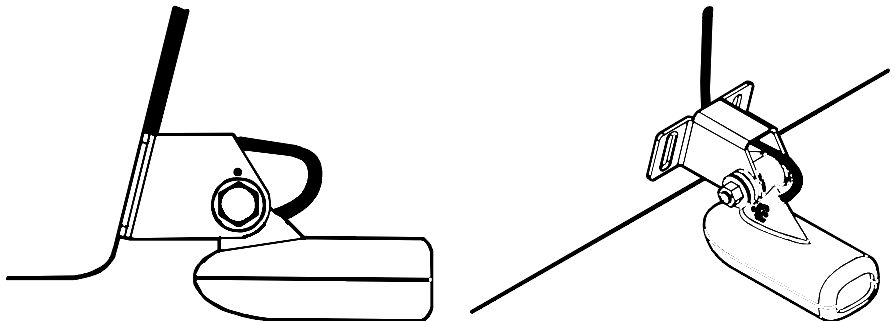

For single-frequency Skimmer, route cable over bolt and through bracket. Side view shown at left and seen from above at right.

Both bracket types: Attach the transducer to the transom. Slide the transducer up or down until it's aligned properly with the bottom of the hull as shown in the preceding and following figures. Tighten the bracket's mounting screws, sealing them with the caulking compound.

Adjust the transducer so that it's parallel to the ground and tighten the nut until it touches the outer washer, then add 1/4 turn. *Don't over tighten the lock nut!* If you do, the transducer won't "kick-up" if it strikes an object in the water.

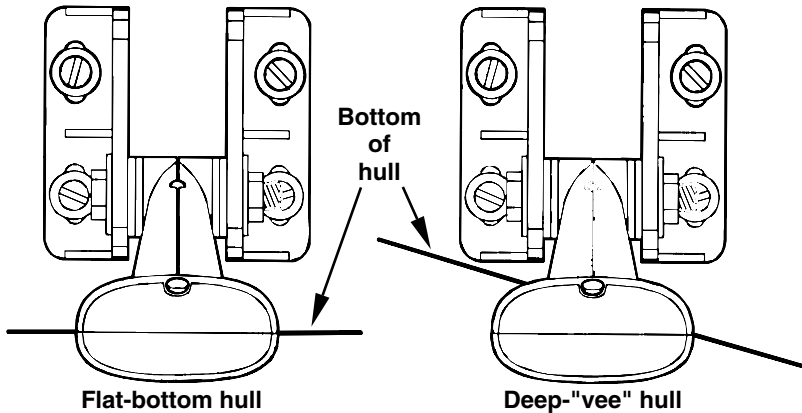

Align transducer centerline with hull bottom and attach transducer to transom. Rear view of dual-frequency Skimmer shown.

6. Route the transducer cable through or over the transom to the sonar unit. Make sure to leave some slack in the cable at the transducer. If possible, route the transducer cable away from other wiring on the boat. Electrical noise from the engine's wiring, bilge pumps, VHF radio wires and cables, and aerators can be picked up by the sonar. Use caution when routing the transducer cable around these wires.

WARNING:

Clamp the transducer cable to the transom close to the transducer. This can prevent the transducer from entering the boat if it is knocked off at high speed.

If you need to drill a hole in the transom to pass the connector through, the required hole size be 1".

CAUTION:

If you drill a hole in the transom for the cable, make sure it is located above the waterline. After installation, be sure to seal the hole with the same marine grade above- or below-waterline sealant used for the mounting screws.

7. Make a test run to determine the results. If the bottom is lost at high speed, or if noise appears on the display, try sliding the transducer bracket down. This puts the transducer deeper into the water, hopefully below the turbulence causing the noise. Don't allow the transducer bracket to go below the bottom of the hull!

TROLLING MOTOR BRACKET INSTALLATION
(single-frequency only)

1. Attach the optional TMB-S bracket to the transducer as shown in the following figure, using the hardware supplied with the transducer. (Note: The internal tooth washer is supplied with the TMB-S.)

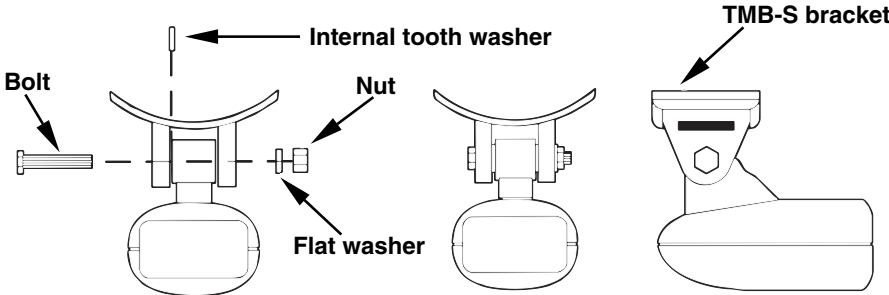

Attach motor mounting bracket to transducer.

2. Slide the adjustable strap supplied with the TMB-S through the slot in the transducer bracket and wrap it around the trolling motor. Position the transducer to aim straight down when the motor is in the water. Tighten the strap securely.
3. Route the transducer cable alongside the trolling motor shaft. Use plastic ties (not included) to attach the transducer cable to the trolling motor shaft. Make sure there is enough slack in the cable for the motor to turn freely. Route the cable to the sonar unit and the transducer is ready for use.

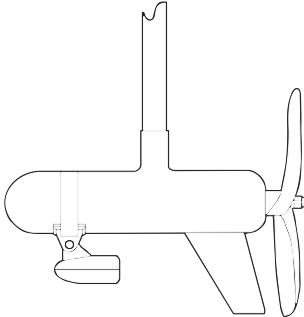

Transducer mounted on trolling motor, side view.

TRANSDUCER ORIENTATION AND FISH ARCHES

If you do not get good fish arches on your display, it could be because the transducer is not parallel with the ground when the boat is at rest in the water or at slow trolling speeds.

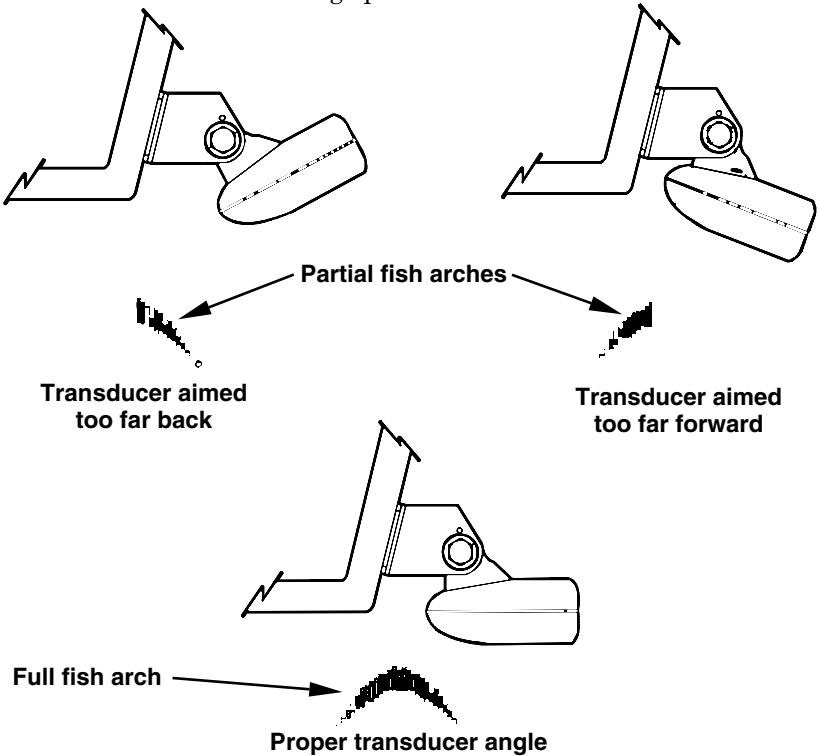

Transducer angles and their effects on fish arches.

If the arch slopes up – but not back down – then the front of the transducer is too high and needs to be lowered. If only the back half of the arch is printed, then the nose of the transducer is angled too far down and needs to be raised.

NOTE:

Periodically wash the transducer's face with soap and water to remove any oil film. Oil and dirt on the face will reduce the sensitivity or may even prevent operation.

SHOOT-THRU-HULL PREPARATION

The transducer installation inside a fiberglass hull must be in an area that does not have air bubbles in the resin or separated fiberglass layers. The sonar signal must pass through solid fiberglass. A successful

transducer installation can be made on hulls with flotation materials (such as plywood, balsa wood or foam) between layers of fiberglass if the material is removed from the chosen area.

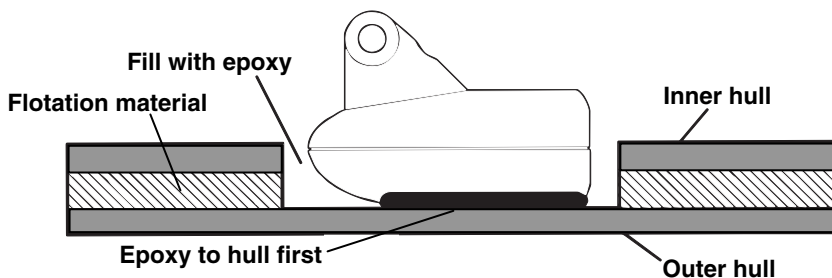

Epoxy the transducer to a solid portion of the hull.

For example, some (but not all) manufacturers use a layer of fiberglass, then a core of balsa wood, finishing with an outer layer of fiberglass. Removing the inner layer of fiberglass and the balsa wood core exposes the outer layer of fiberglass. The transducer can then be epoxied directly to the outer layer of fiberglass. After the epoxy cures, the hull is watertight and structurally sound. Remember, the sonar signal must pass through solid fiberglass. Any air bubbles in the fiberglass or the epoxy will reduce or eliminate the sonar signals.

WARNING:

Do not remove any material from your inner hull unless you know the hull's composition. Careless grinding or cutting on your hull can result in damage that could sink your boat. Contact your boat dealer or manufacturer to confirm your hull specifications.

To choose the proper location for thru-hull mounting, anchor the boat in 60 feet of water. Add a little water to the sump of the boat. Plug the transducer into the sonar unit, turn it on, then hold the transducer over the side of the boat. Adjust the sensitivity and range controls until a second bottom echo is seen on the display. (You will need to turn off both automatic and ASP™.) Don't touch the controls once they've been set.

Next, take the transducer out of the water and place it in the water in the sump of the boat. Observe the sonar signal to see if there is a noticeable decrease in sensitivity. The second bottom signal may disappear and the bottom signal may decrease in intensity.

Move the transducer around to find the best location. If the sensitivity control must be increased greatly to compensate, then the transducer should be mounted on the outside of the hull. If not, then mark the lo-

caution that shot through the hull the best and follow the instructions on the following pages for a shoot-thru-hull mounting.

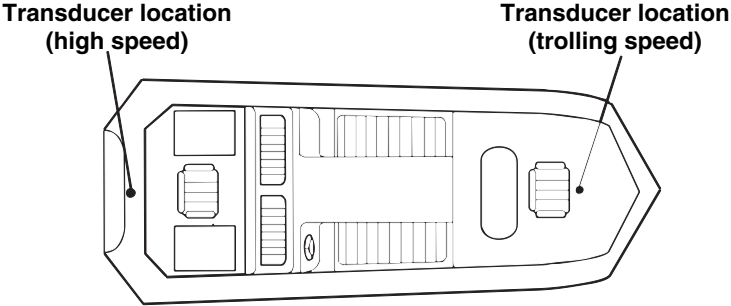

Shoot-thru-hull transducer locations for high speed or trolling speed operation.

Shoot-thru-hull Installation

1. Make sure the area is clean, dry and free of oil or grease, then sand both the inside surface of the hull and the face of the transducer with 100 grit sandpaper. The surface of the hull must be flat so the entire transducer face is in contact with the hull prior to bonding.

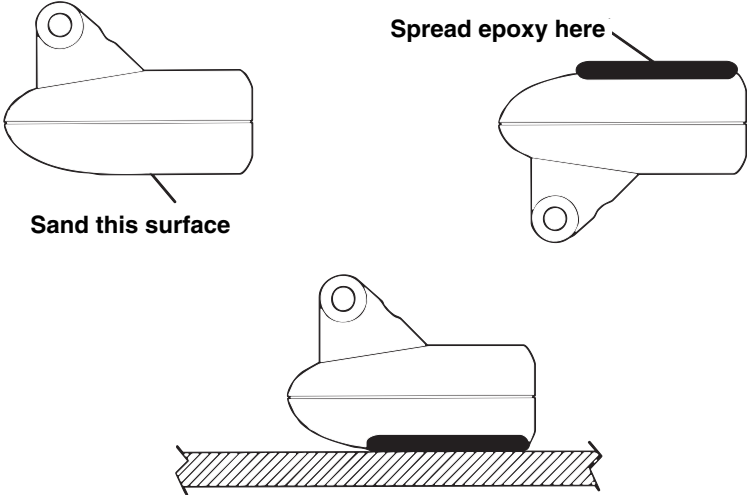

Epoxy transducer to hull.

2. Follow the instructions on the epoxy package and mix it thoroughly. Do not mix it too fast, because it will cause bubbles to form in the epoxy. Apply a small amount on the face of the transducer as shown above, then spread a small amount onto the sanded area on the hull.

Place the transducer into the epoxy, twisting and turning it to force any air bubbles out from under the transducer face. The face of the transducer should be parallel with the hull, with a minimum amount of epoxy between the hull and transducer. After the epoxy dries, route the cable to the sonar unit.

Speed/Temperature Sensors

This unit accepts up to three temperature sensors which can monitor surface water, live well, air and virtually any other temperature. If you want to use more than one temperature sensor or a speed sensor, you must purchase the optional MY-4X adapter cable. You also need to be careful when purchasing the temperature sensors, because each temperature sensor has its own fixed electronic "address." The sensors are labeled "Water," "T-2" (or Temp-2) and "T-3" (or Temp-3).

The first "Water" temperature sensor is built into the transducer. This is the sensor that measures surface water temperature. If you want two (or more) temperature readings from other locations, you'll need to use the proper sensors. For example, you can't use two additional T-3 sensors. The sensors that fit this unit are:

- TS-1X This sensor will over-ride the temperature sensor built into the transducer and over-ride the temperature sensor in a ST-TGY combination sensor. (This sensor is not recommended.)
- TS-2X One sensor for "T-2" temperature display.
- TS-3X One sensor for "T-3" temperature display.
- SP-X One speed sensor for "Speed" display.
- ST-TGY This combination sensor will provide speed and temperature readings, but the temperature reading will be displayed as the "Water" temperature because it will over-ride the temperature sensor in the transducer. (This sensor is not recommended.)

See the wiring diagram on the following page for temperature and speed sensor combinations.

Sensor Chart

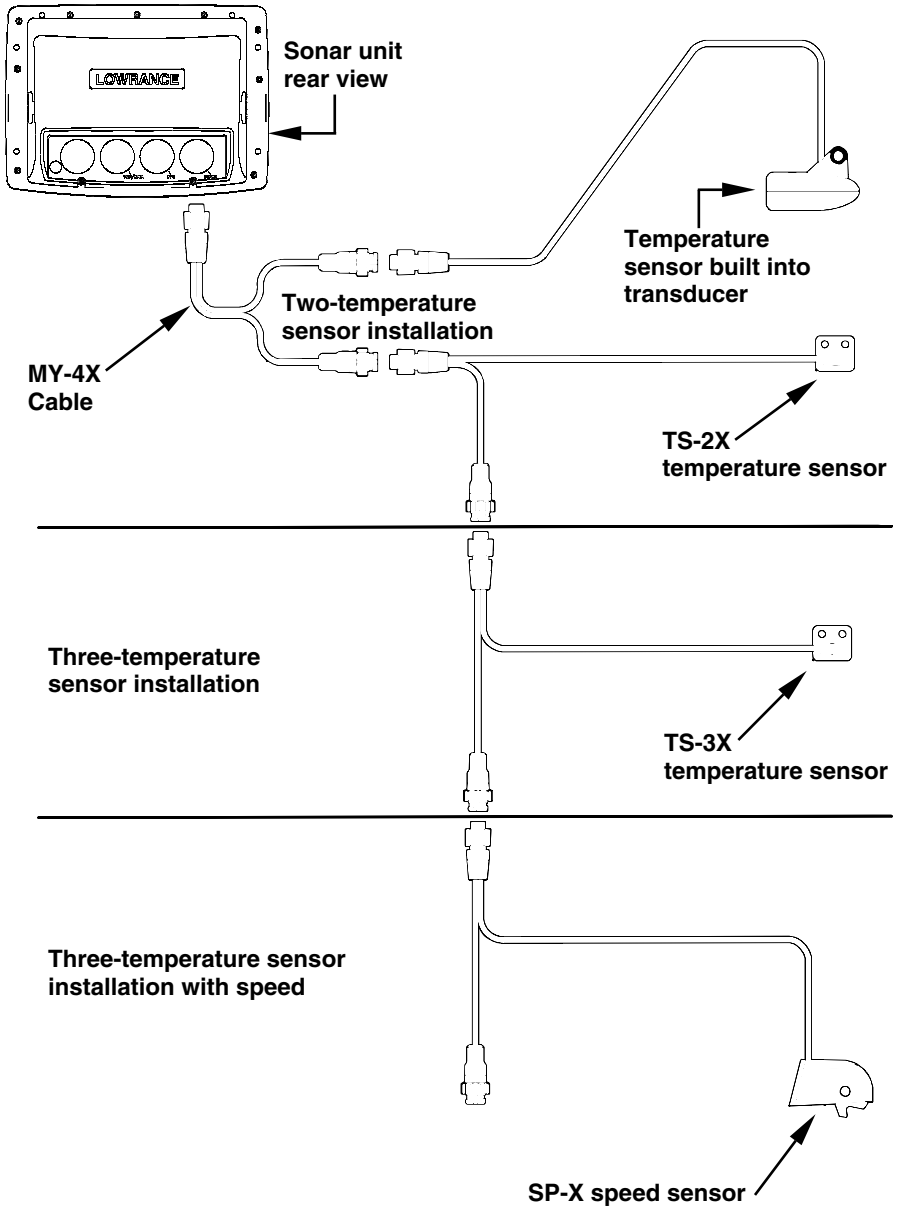

Optional Speed Sensor Installation

This unit can display speed and distance traveled; the feature requires a speed sensor which may or may not come packaged with your unit. (If you wish to purchase an optional additional sensor for your unit, refer to the accessory ordering information inside the back cover of this manual.) The following instructions describe how to install the speed sensor.

Recommended tools for this job include: drill, 7/8" drill bit, 1/8" drill bit for pilot holes, screwdriver. Required supplies for this job include: four #8 stainless steel wood screws (3/4" long), *high quality, marine grade* above- or below-waterline caulking compound.

First find a location on the boat's transom where the water flow is smoothest. Don't mount the sensor behind strakes or ribs. These will disturb the water flow to the speed sensor. Make sure the sensor will remain in the water when the boat is on plane. Also make sure the location doesn't interfere with the boat's trailer. Typically, the sensor is mounted about one foot to the side of the transom's centerline.

Once you've determined the proper location for the unit, place the sensor on the transom. The bottom of the bracket should be flush with the hull's bottom. Using the sensor as a template, mark the hull for the screws' pilot holes. Drill four 1/8" holes, one in each end of the slots.

Mount the sensor to the hull using #8 stainless steel wood screws (not included). Use a *high quality, marine grade* above- or below-waterline caulking compound to seal the screws. Make sure the sensor is flush with the bottom of the hull and tighten the screws.

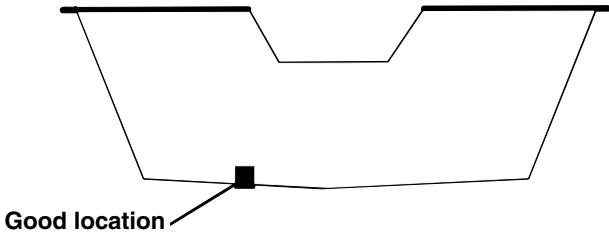

Stern view showing good location for mounting sensor on transom.

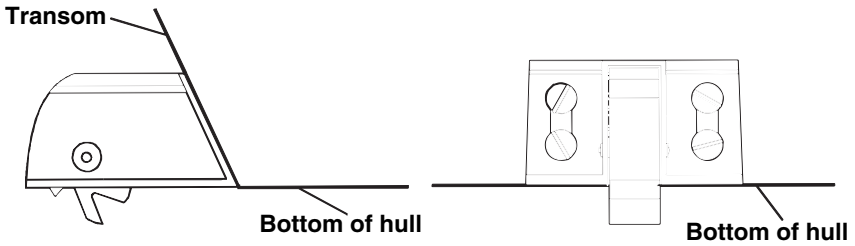

**Speed sensor mounting configuration:
side view (left) and rear view (right.)**

If the base of the transom has a radius, fill the gap between the transom and the sensor with the caulking compound. This will help ensure a smooth water flow.

Route the sensor's cable through or over the transom to the sonar unit. If you need to drill a hole in the transom to pass the connector through, the required hole size is 7/8".

CAUTION:

If you drill a hole in the transom for the cable, make sure it is located above the waterline. After installation, be sure to seal the hole with the same marine grade above- or below-waterline sealant used for the screws.

The sensor is now ready for use. Connect the sensor to the in-line connector on the MY-4X adapter cable. If you have any questions concerning the installation of the sensor, please contact your local boat dealer.

GPS Antenna/Receiver Module

This unit's package includes the LGC-12w GPS module. This device contains the unit's external antenna and receiver for GPS and WAAS signals. The antenna/receiver module comes with a 25-foot extension cable. This module can be mounted on a flat surface or pole, or a magnet is included for temporary mounting on any ferrous surface. (The LGC-12s GPS module sold with earlier Lowrance equipment will work with your unit, but it will not receive WAAS signals.)

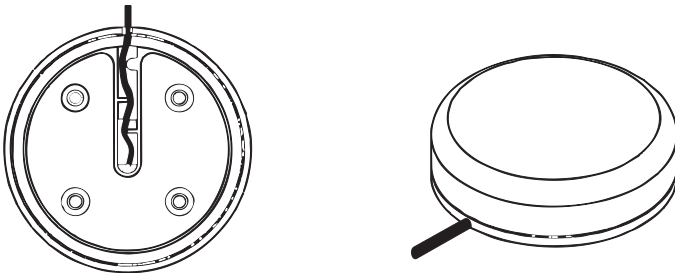

LGC-12 Module, bottom view (left) and top view (right).

You need to select an antenna installation location that has a clear, unobstructed view of the sky. After the module is installed, route the cable to the unit, plug it in the center socket on the back and your system is ready to use. See the module's instruction sheet, publication part number 988-0147-39, for complete installation directions.

In an automobile, you may achieve good results by simply placing the external antenna on the top of the dash, at the base of the windshield. A piece of the rubber non-skid shelf liner material available in recreational vehicle supply stores will help hold the antenna in place. This may not work well if you have a cab-over design pickup truck camper or motor home. If dashboard reception is poor, simply relocate the antenna module elsewhere on the vehicle for a clearer view of the sky.

Power Connections

The unit works from a 12-volt battery system. For the best results, attach the power cable directly to the battery. You can attach the power cable to an accessory or power buss, however you may have problems with electrical interference. Therefore, it's safer to go ahead and attach the power cable directly to the battery.

If possible, keep the power cable away from other boat or vehicle wiring, especially the engine's wires. This will provide the best isolation from electrical noise. If the cable is not long enough, splice #18 gauge wire onto it. The power cable has two wires, red and black. Red is the positive lead, black is negative or ground. Make sure to attach the in-line fuse holder to the red lead *as close to the power source as possible*.

For example, if you have to extend the power cable to the battery or power buss, attach one end of the fuse holder directly to the battery or power buss. This will protect both the unit and the power cable in the event of a short. It uses a 6-amp fuse.

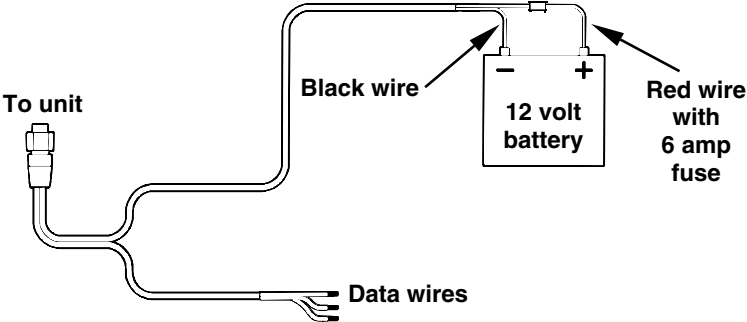

**Power connections for this sonar/GPS unit.
External speaker wires are not shown.**

CAUTION:

Do not use this product without a 6-amp fuse wired into the power cable! Failure to use a 6-amp fuse will void your warranty.

This unit has reverse polarity protection. No damage will occur if the power wires are reversed. However, the unit will not work until the wires are attached correctly.

An optional 8-foot, CA-4 external power cable with a cigarette lighter adapter is available from Lowrance.

NMEA/DGPS Cable Connections

NMEA is a standard communications format for marine electronic equipment. For example, an autopilot can connect to the NMEA interface on this unit and receive positioning information. The unit can exchange information with any device that transmits or receives NMEA 0183 data.

DGPS is an acronym for the Differential Global Positioning System. DGPS supplements and boosts the accuracy of basic GPS. DGPS was developed by the U.S. Coast Guard, which is responsible for the system's operation in the United States. Since its creation, DGPS has become the international maritime standard for marine navigation.

The most popular DGPS system relies on a grid of ground-based transmitters that send correction signals to DGPS receivers. These in turn, connect to the GPS receiver (such as the LCX-104C). Lowrance offers an optional DGPS receiver for your unit.

See the following diagrams for general wiring connections. Read your other product's owner's manual for more wiring information.

NMEA/DGPS Wiring

To exchange NMEA or DGPS data, the unit has two NMEA 0183 version 2.0 communication ports. Com port one (Com-1) can be used to receive NMEA format GPS data or DGPS data. Com-1 can also transmit NMEA format GPS data to another device. Com-2 is for NMEA output only.

The three wires for the com port are combined with the two power wires and the speaker wires to form the power/data cable (see the drawing on page 33). Com-1 uses the yellow wire to transmit, the orange wire to receive and the shield wire for signal ground. Com-2 uses the blue wire for transmit.

Communication Port Wiring Diagrams



Com-1 wiring to receive DGPS position information from a DGPS receiver.

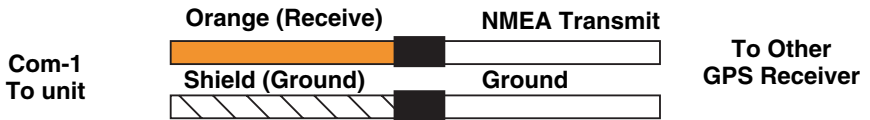

Com-1 wiring to receive NMEA position information from some other GPS receiver.

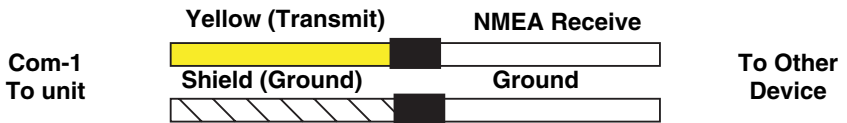

Com-1 wiring to transmit NMEA position information to another NMEA-compatible device.



Com-2 wiring to transmit NMEA position information to another NMEA-compatible device.

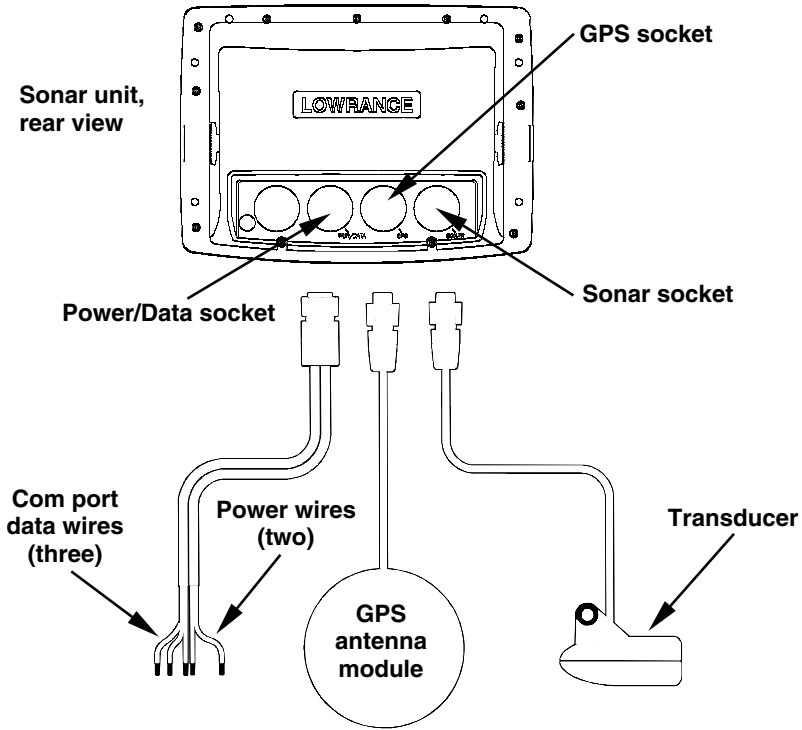

Cable connections.

Note: External speaker wires in power/data cable not shown.

Mounting the Unit: Bracket or In-Dash

You can install the unit on the top of a dash with the supplied gimbal bracket. It can also be installed in the dash. For an in-dash mount, consult the factory customer service department. Service contact information is inside the back cover of this manual.

Bracket Installation

Mount the unit in any convenient location, provided there is clearance behind the unit when it's tilted for the best viewing angle. You should also make sure there is enough room behind the unit to attach the power, transducer and GPS antenna/receiver module cables. (A drawing on the next page shows the dimensions of a gimbal-mounted unit.)

Holes in the bracket's base allow wood screw or through-bolt mounting. You may need to place a piece of plywood on the back side of thin fiberglass panels to reinforce the panel and secure the mounting hardware.

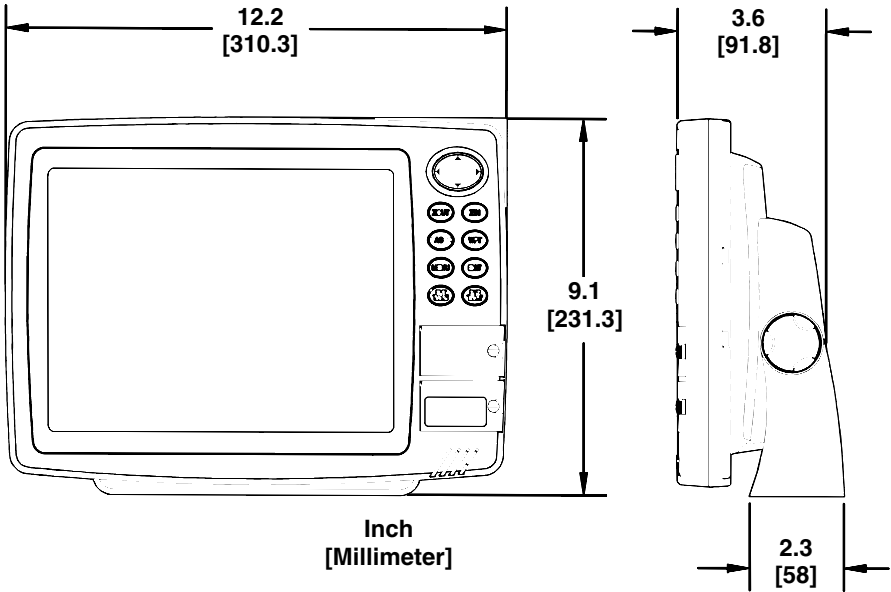

Front view (left) and side view (right) showing dimensions of the sonar/GPS unit when mounted on gimbal bracket.

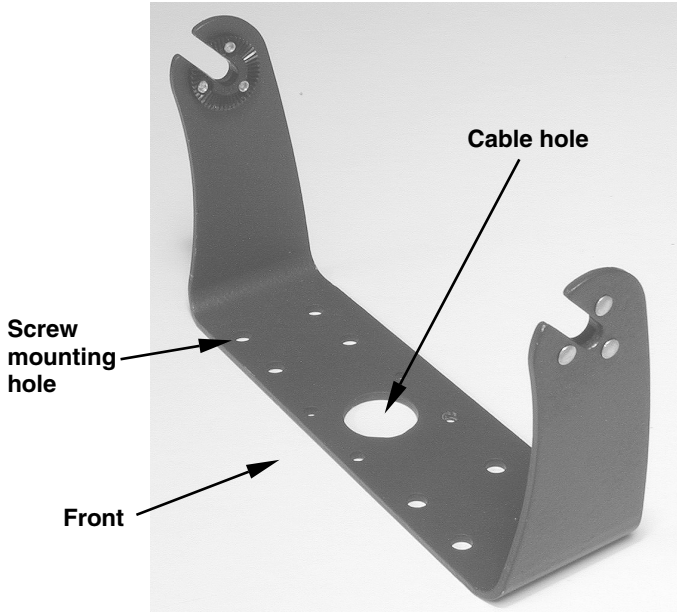

Install the gimbal bracket. Orient the bracket so the arms slope toward the front of your unit.

Once a location is determined, use the bracket as a template and mark the mounting holes and the hole for the cables. Drill a 1-inch (25.4 mm) hole in the dash for the power, transducer and antenna cables. Screw the bracket to the mounting surface.

To pass all connectors through the 1" hole, first pass the transducer connector *up* through the hole from under the dash, followed by any accessory cables. Next, pass the power cable's bare-wire end *down* through the hole from the top.

If you wish, you can fill in the hole around the cables with a good marine caulking compound. Be sure to leave enough slack in the cables to allow tilting the unit.

Attach the unit to the gimbal bracket using the supplied gimbal knobs and washers, attach the cables and the unit is ready to use.

MMC or SDC Memory Card Installation

Your unit uses MultiMedia Cards to store information, such as sonar logs, custom maps, waypoints, trails and other GPS data. The unit can also use Secure Digital Cards (SD card or SDC) to store data. The unit can use up to two cards at the same time; an MMC and an SDC can be used together at the same time.

NOTE:

Throughout this manual, we will use the term MMC, but just remember that your unit can use an MMC *or* SDC to store data.

Both of these solid-state flash memory devices are about the size of a postage stamp. An SD card is slightly thicker than an MMC. As this manual went to press, MMCs were available in storage capacities of 8 MB, 16 MB, 32 MB and 64 MB. SD cards were available in capacities of 8 MB, 16 MB, 32 MB, 64 MB, 128 MB and 256 MB.

Additional MMC cards are available from LEI Extras; see ordering information inside the back cover of this manual. MMCs and SD cards are also available at many camera and consumer electronics stores.

The two MMC slots are located in compartments on the front of the case. The water-proof compartment doors are located at the lower right corner. The following figure shows a close-up of one compartment with the door opened.



Memory card compartment with a 16 MB MMC card installed.

To remove an MMC

1. Open the card compartment door by unscrewing the thumb screw. The screw should only be finger tight. If it was over-tightened, use a thumbnail, a coin or a screwdriver to open the door.
2. Use a thumbnail or fingernail to grab the groove in the bottom of the MMC. See the figure above for the groove location.
3. Drag the MMC from the slot.

To add an MMC or SDC

1. Open the card compartment door.
2. Grasp the bottom of the MMC and push the top of the card into the slot. Once the card is started, use your fingernails to slide it the rest of the way to the left, until it is firmly seated in the slot.
3. Close the compartment door and fasten the thumb screw finger tight.

Other Accessories

Screen Cleaning Kit

Your unit's display screen is equipped with a special anti-glare filter that improves readability in a wide range of lighting conditions. A bottle of filter cleaning fluid is included with your unit. Additional bottles of cleaner may be purchased from your dealer or LEI Extras, the accessory source for Lowrance equipment. Accessory ordering information is on the inside back cover of this manual.

WARNING:

Improperly cleaning your unit's screen can result in damage to the anti-glare filter. This type of damage is not covered by the warranty. To protect the screen and

its anti-glare properties, always use the special cleaner available from your dealer or LEI Extras.

To remove fingerprints, water spots, dust or other grime from the screen, hold the bottle about 6 inches (15 cm) from the screen and spray. Wipe immediately with a clean, dry, lint-free cloth.

MMC and MapCreate

Other available accessories include MMC cards, MMC card readers and MapCreate™ 6 custom mapping software for your computer. MMC card readers are available in USB and parallel port versions. This unit ships with the MapCreate accessory pack, which includes the software, one USB card reader and one 16 MB MMC. See the MapCreate manual and the card reader instruction sheet for installation information.

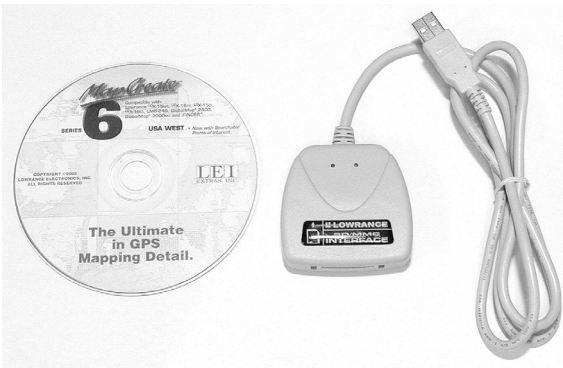

MapCreate™ 6 CD-ROM, left; MMC card reader for USB ports, right.

Switch Boxes

Two switch boxes are available for this unit. The SB-7X transducer switch box switches two transducers to one sonar unit. The SB-8X transducer switch box switches two sonar units to one transducer.

If these accessories are not available from your dealer, see the accessory ordering information on the inside back cover of this manual. Visit our web site for a complete listing of all the available accessories for your unit.

External Speaker

Your unit can play sounds to an external speaker. This feature can be convenient any time you are away from the unit – especially in a larger boat – but still want to hear its alarms. You might install a small speaker at the stern of your boat so you won't miss a dangerous Shallow Alarm while fishing, or put one in your galley so you can hear the GPS Arrival Alarm.

You can purchase an external speaker at your nearest audio electronics store. The unit is designed to work with most speakers, but make sure to buy one that meets these minimum requirements:

- Minimum 8-ohm resistance
- Minimum 5-watt power

In your vessel or vehicle, mount the speaker wherever you want to hear your unit's sounds. (Follow the speaker's installation instructions).

Next, connect the speaker to your unit. The external audio wires are the labeled red and black wires in the power/data cable. The speaker's input cable should have two exposed wires: a positive and a negative (ground). Connect the speaker's positive wire to the unit's red speaker wire, and the speaker's negative (ground) wire to the unit's black speaker wire.

The unit should automatically begin to play any active sounds through the attached speaker.

Face Cover

Your unit comes with a white protective cover that snaps on and off the front of the unit. When the unit is in storage, the cover protects the screen from damage that can result from long-term exposure to the sun's ultraviolet rays. This cover is intended for use when your unit and the vehicle it's mounted in are idle.

WARNING:

When the unit is mounted in an unprotected area, such as an open boat cockpit, the protective face cover must be removed when the vehicle is moving at high speed. This includes towing a boat on a trailer at highway speeds. Otherwise, wind blast can pop off the cover.

Now that you have your unit installed, move on to Sec. 3, *Basic Sonar Operations*. There, we'll present a series of step-by-step tutorials to teach you the basics of your sonar operation.

NOTE:

When you first turn the unit on, the Map Page appears. If you'd rather start learning about GPS operation first, turn over to Sec. 6, *Basic GPS Operations*. (Remember, you don't need to read this manual from cover-to-cover to get going. We designed it so you can skip around to the section *you* want to read.)

Section 3:

Basic Sonar Operation

This section addresses the unit's *most basic* sonar operations. The instructions presented in Sec. 3 follow a chronological order. Sec. 4, *Sonar Options & Other Features*, will discuss other more advanced functions and utilities. Material in Sec. 4 is arranged in alphabetical order.

Before you turn on the unit, it's a good idea to learn about the different keys, the Main Menu, the four Page screens and how they all work together. BUT, if you just can't wait to get on the water, turn to the one-page *Quick Reference* on page 47.

Keyboard

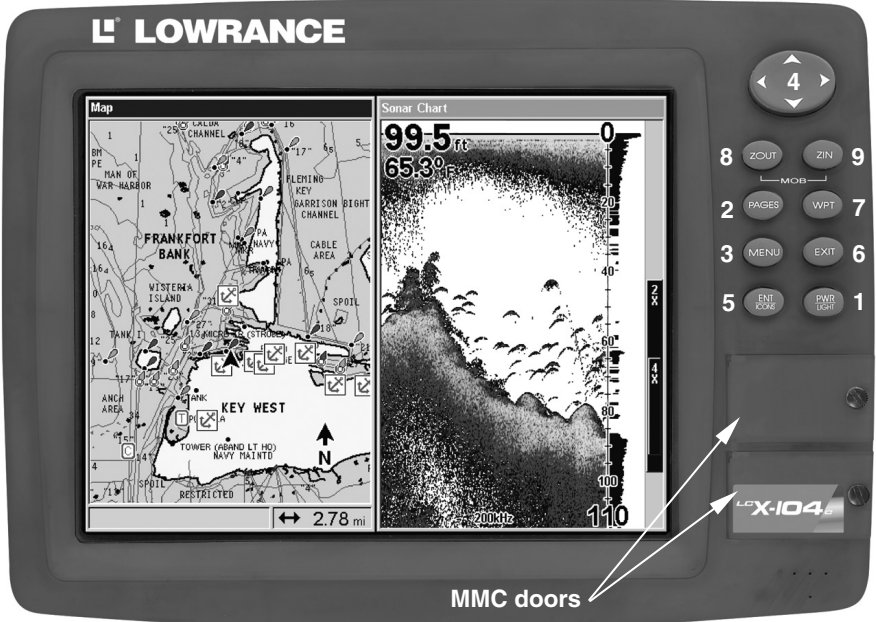

LCX-104C sonar/GPS unit, front view, showing sonar screen, keyboard and access doors for the MMC compartment.

1. **PWR/LIGHT** (Power & Light) – The PWR key turns the unit on and off and activates the backlight.
2. **PAGES** – Pressing this and the ← → arrow keys switches the unit between the four different page screens. (Satellite Status Page, Navigation Page, Map Page and Sonar Page.) Each page represents one of the unit's major operation modes.

3. **MENU** – Press this key to show the menus and submenus, which allow you to select a command or adjust a feature. This also accesses search functions for streets, intersections, addresses and highway exits.

4. **ARROW KEYS** – These keys are used to navigate through the menus, make menu selections, move the map and sonar chart cursors and enter data.

5. **ENT/ICONS** (Enter & Icons) – This key allows you to save data, accept values or execute menu commands. It is also used to create event marker icons.

6. **EXIT** – The Exit key lets you return to the previous screen, clear data or erase a menu.

7. **WPT** – (Waypoint) The Waypoint key is used to save and recall waypoints, search for waypoints and access the waypoint list. It also launches the Point-of-Interest (POI) search menus and is involved in some navigation functions.

8. **ZOUT** – (Zoom Out) – This key lets you zoom the screen out. On the Sonar Page, this key returns you to a full sonar chart display, showing the entire water column from surface to bottom. On the Map Page, this lets you see a larger geographic area on the map. Less detail is seen as you zoom out.

9. **ZIN** – (Zoom In) – This key lets you zoom the screen in. On the Sonar Page, this key enlarges fish signals and bottom detail. On the Map Page, zooming in lets you see greater detail in a smaller geographic area on the map.

Power/lights on and off

To turn on the unit, press **PWR**. As the unit powers up, the Map Page is displayed first. To switch to the Sonar Page, press **PAGES** |→| **EXIT**.

To turn on the backlight, press **PWR** again. The unit has three backlight levels to select from. Repeatedly pressing **PWR** will cycle through the backlight settings and turn off the backlight.

Turn off the unit by pressing and holding the **PWR** key for 3 seconds.

Main Menu

The unit has a Main Menu, which contains some function commands and some setup option commands. The instructions in this section will deal only with sonar functions, the basic commands that make the unit show sonar signals on your screen. This unit will work fine right out of the box with the factory default settings. But, if you want to learn

about the various sonar options, see Sec. 4, *Sonar Options & Other Features*. (For general system setup and GPS options, see Sec. 8, *System Setup and GPS Setup Options*.)

You can access the Main Menu from any of the four Page screens by pressing **MENU | MENU**. To clear the menu screen and return to the page display, press **EXIT**. (Remember, our text style for "**MENU | MENU**" means "press the Menu key twice." See a full explanation of our instruction text formatting on page 10, *Instructions = Menu Sequences*.)

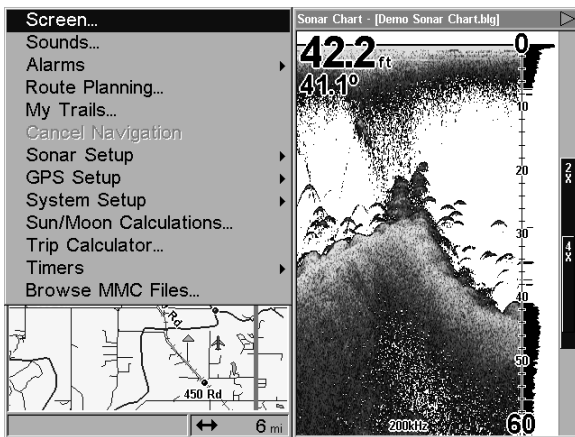

Main Menu.

The Main Menu commands and their functions are:

Screen command: changes the contrast or brightness of the display screen.

Sounds command: enables or disables the sounds for key strokes and alarms and sets the alarm style.

Alarms command: turns GPS alarms on or off and changes alarm thresholds.

Route Planning command: used to plan, view or navigate a route.

My Trails command: shows, creates and deletes plot trails. Also used to navigate or backtrack a trail.

Cancel Navigation command: turns off the various navigation commands. Used to stop navigating after you have reached your destination waypoint, Point of Interest or map cursor location; or after you reach the end of a route or trail.

Sonar Setup command: sets various sonar options.

GPS Setup command: sets various GPS receiver options.

System Setup command: sets general configuration options.

Sun/Moon Calculations command: finds the rising and setting time of the sun and the moon.

Trip Calculator command: shows trip status and statistics.

Timers command: controls the up timer, down timer and alarm clock settings.

Browse MMC Files command: this allows you to view the installed MMC card and the files it contains.

Pages

The unit has four Page displays that represent the four major operating modes. They are the Satellite Status Page, the Navigation Page, the Map Page and Sonar Page. They are accessed by pressing the **PAGES** key, then using → or ← to select a Page. (Clear the Pages Menu by pressing **EXIT**.)

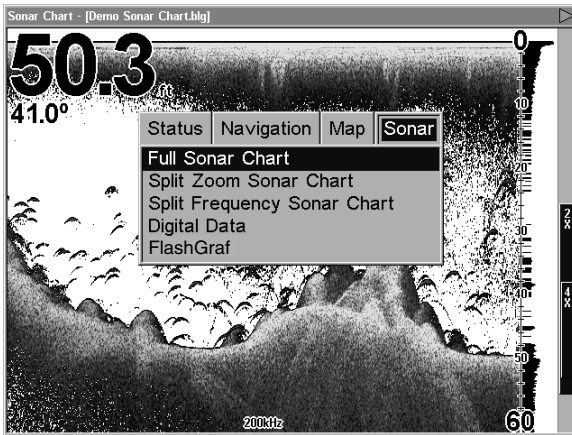

Pages Menu, showing some Sonar display options.

Satellite Status Page

The Satellite Status Page provides detailed information on the status of the unit's satellite lock-on and position acquisition. To get to the Satellite Status Page: Press the **PAGES** key, then use → or ← to select **STATUS**. (Clear the Pages Menu by pressing **EXIT**.)

This page represents a GPS function, so it is discussed in much greater detail in Sec. 6.

No matter what Page you are on, a flashing current position indicator/question mark symbol and flashing GPS data displays indicate that satellite lock has been lost and there is no position confirmed.

WARNING:

Do not begin navigating with this unit until the numbers have stopped flashing!

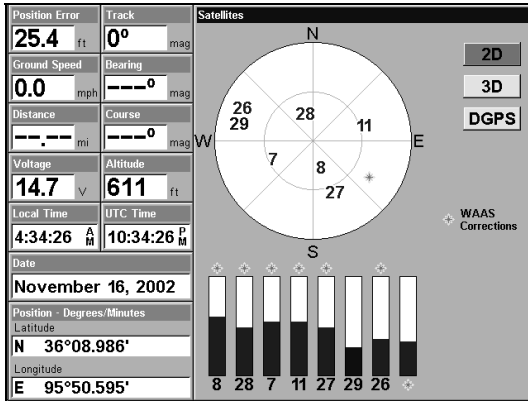

Satellite Status Page showing satellite lock-on with a 3D position acquired (latitude, longitude and altitude), including WAAS reception.

Navigation Page

This screen has a compass rose that not only shows your direction of travel, but also the direction to a recalled waypoint. To get to the Navigation Page: Press **PAGES** | → or ← to **NAVIGATION** | **EXIT**.

This page represents a GPS function, so it is discussed in much greater detail in Sec. 6.

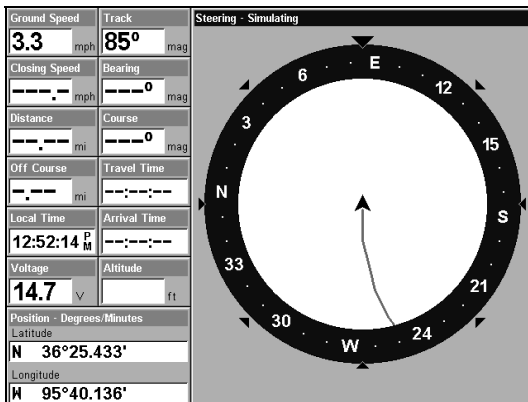

Navigation Page, recording a trail, traveling east.

Map Page

The Map Page screens show your course and track from a "bird's-eye" view, on a moving map. By default, this unit shows the map with north

always at the top of the screen. The arrow in the center of the screen is your present position. It points in the direction you're traveling.

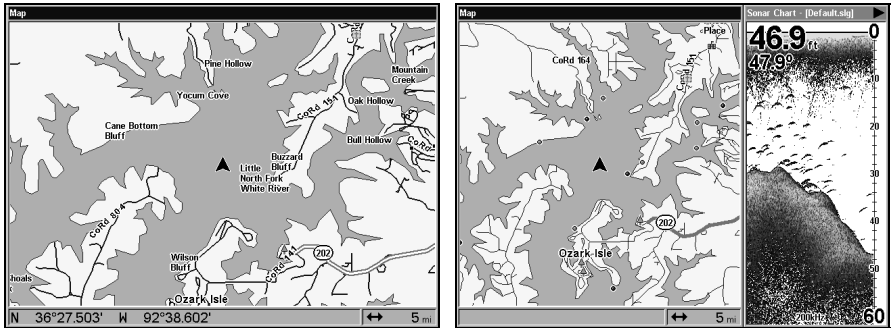

Map Page, showing position on Bull Shoals Lake, Arkansas. At left is the full map option. At right, map with sonar option.

Map Page is also the default screen that appears when you turn on the unit. To get to the Map Page from another page: Press **PAGES** | → or ← to **MAP** | **EXIT**.

You can display a split screen showing both the Map and Sonar pages at the same time. This feature is discussed in Sec. 4, *Sonar Options & Other Features*.

The Map Page represents a GPS function, so it is discussed in much greater detail in Sec. 6.

Sonar Page

The Sonar Page displays the sonar chart. This is a "cross-section" view of the water column beneath the boat. The chart moves across the screen, displaying sonar signal echoes that represent fish, structure and the bottom.

To get to the Sonar Page: Press the **PAGES** key, then use → or ← to select **SONAR**. (Clear the Pages Menu by pressing **EXIT**.) The Pages Menu also offers five chart display options under the Sonar Page category. To access them, press **PAGES** | ← or → to **SONAR** | ↓ to *Option Name* | **EXIT**.

The Sonar Page also has its own menu, which is used for some advanced functions and for setting various options. (Sonar Options and other features are discussed in Sec. 4.) To Access the Sonar Page menu, from the Sonar Page press **MENU**.

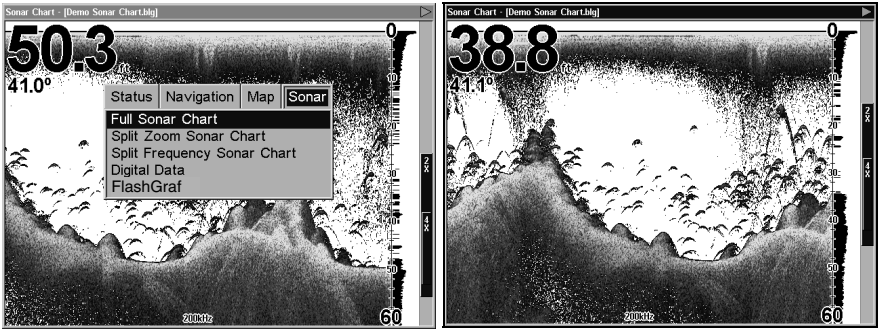

At left, Pages Menu, showing sonar chart display option commands.
 At right, Sonar Page in full sonar chart display mode.

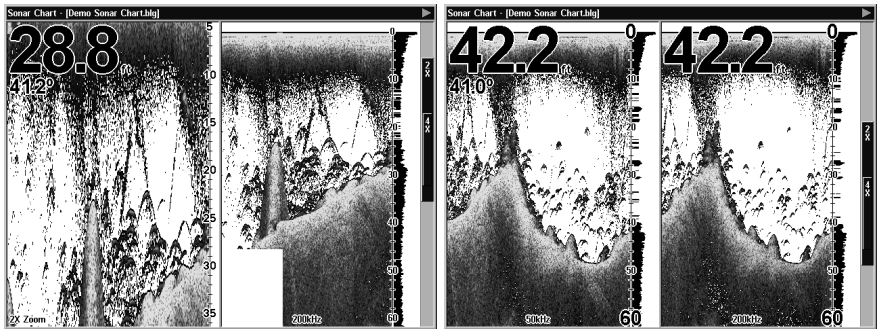

Sonar chart display options (from left) split zoom and split frequency.

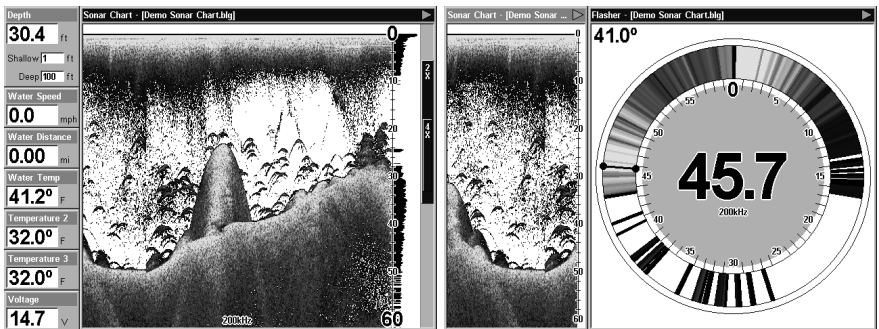

Sonar chart display options (from left) digital data and FlashGraf™ .

Tip:

You can adjust the horizontal window size on pages with two major windows, such as FlashGraf. Read about the *Resize Windows* command on page 102.

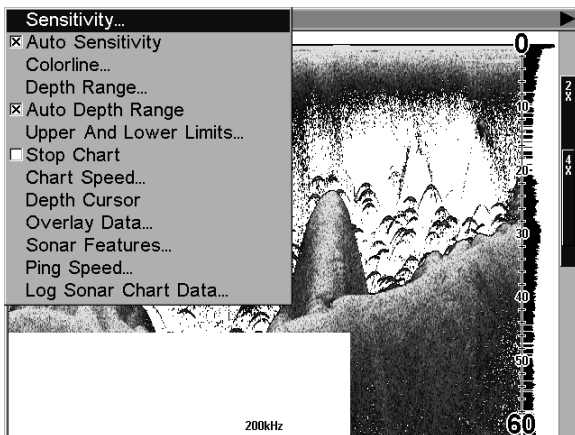

Sonar Page Menu. Most of these functions are discussed in Sec. 4.

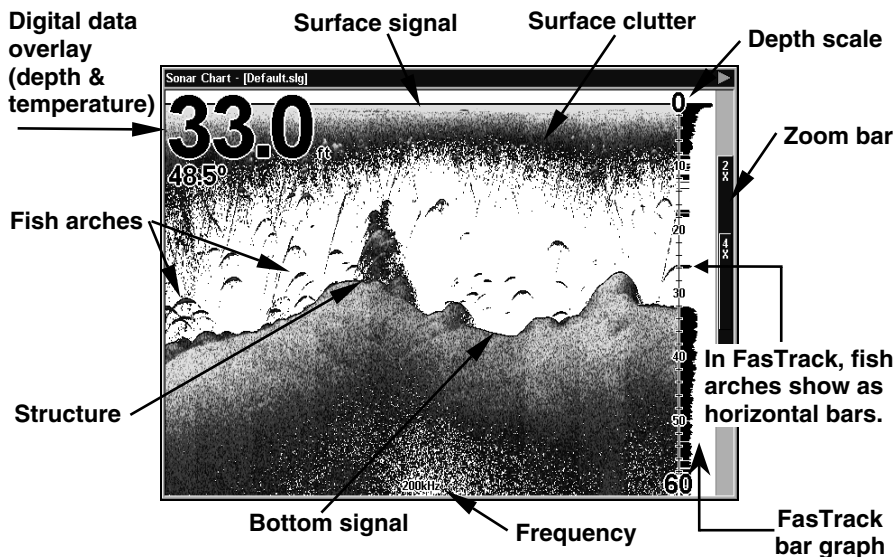

Sonar Page, showing full sonar chart mode.

You can customize how the Sonar Page displays its pictures and other data in many ways. Your unit also includes several special sonar features and options that can help you better interpret the underwater scene.

We'll discuss all of those features and options in Sec. 4, but to show you how easy the unit is to operate, the following page contains a simplified, 10-step quick reference that will cover most fish finding situations. The quick reference describes how your unit will operate with all the sonar features in their automatic modes, which are set at the factory.

LCX-104C Sonar Quick Reference

1. Mount the transducer, antenna and unit. Connect the unit to electric power and the transducer. (If GPS operation is desired, connect GPS antenna, too.) Make sure the MMC is in. (See complete installation details beginning on page 13.)

2. Launch your boat.

3. To turn on the unit, press and release **PWR** key.

4. Opening screen displays Map Page. Rotate through the four main Page screens (Map Page, Satellite Status Page, Navigation Page, Sonar Page) by pressing **PAGES** |← or → to select *Page Name* |**EXIT**. Switch Pages to display Sonar Page.

5. If GPS data is desired, wait while unit locates satellites and calculates current position. When the unit acquires position, a tone sounds and a position acquired message appears.

6. With position acquired (if desired), head for your fishing grounds. Your unit will automatically display digital depth and surface water temperature in the top left corner of the screen.

The auto settings will track the bottom, displaying it in the lower portion of the screen. The full sonar chart will scroll from right to left, showing you what's under the boat as you cruise across the water. You can change the display by:

Zoom in to enlarge the chart for more detail: press **ZIN**.

Zoom out to return to full chart mode: press **ZOUT**.

7. Watch the display for the appearance of fish arches. When you see arches, you've found fish! Stop the boat and get your lure or bait into the water at the depth indicated on the sonar chart.

8. Gauge the fish depth by visually comparing the fish arches with the depth scale on the right side of the screen, or get a more accurate measure with the Depth Cursor. Press **MENU** |↓ to **DEPTH CURSOR** |**ENT**. Press ↓ to align the cursor line with the fish arch. The exact depth appears in a box at the right end of the cursor line. To clear the cursor, press **EXIT**.

9. If you are drifting at a very low speed or anchored, you are not moving fast enough for a fish to return the tell-tale fish arch signal. As you drift over a fish, or as a fish swims through the transducer's signal cone, the fish echo will appear as a straight line suspended between the surface and the bottom.

10. To turn off the unit, press and hold **PWR** key for three seconds.

Sonar Operations

As you can see from the quick reference on the previous page, basic operation is pretty easy, right out of the box. If you are a sonar novice, try operating the unit with the factory defaults until you get a feel for how it's working.

As you're learning the basics, there is one setting you might want to tinker with from time to time — Sensitivity.

Sensitivity controls the unit's ability to pick up echoes. If you want to see more detail, try increasing the sensitivity, a little at a time. There are situations when too much clutter appears on the screen. Decreasing the sensitivity can reduce the clutter and show the strongest fish echoes, if fish are present. As you change the sensitivity setting, you can see the difference on the chart as it scrolls.

Fig. 1

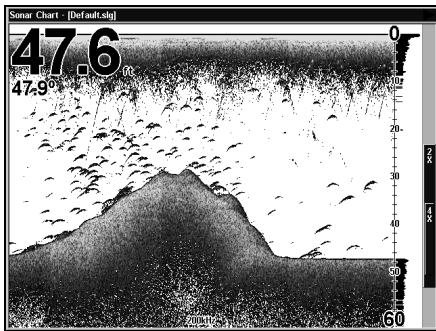

Fig. 2

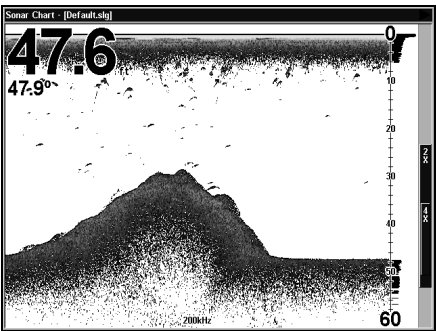

Fig. 3

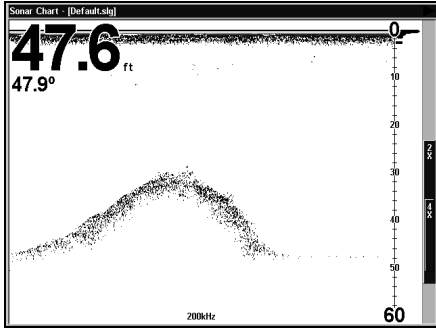

Fig. 4



These figures show results of different sensitivity levels on the same location. Fig. 1: Sensitivity at 88 percent, determined by Auto Sensitivity. Typical of full auto mode. Fig. 2: Sensitivity set at 75 percent. Fig. 3: Sensitivity set at 50 percent. Fig. 4: Sensitivity set at 100 percent.

You can change the sensitivity level whether you are in Auto Sensitivity mode or Manual Sensitivity mode. The adjustment method works the same in both modes, but it gives you slightly different results.

Adjusting sensitivity in Auto Sensitivity Mode is similar to manually adjusting a car's speed with the accelerator pedal while cruise control is on. You can tell the car to run faster, but when you let off the gas the cruise control *automatically* keeps you from running slower than the minimum speed setting. In this unit, auto mode will let you increase sensitivity to 100 percent, but the unit will *limit* your *minimum* setting. This prevents you from turning sensitivity down too low to allow automatic bottom tracking. When you change the setting with auto turned on, the unit will continue to track the bottom and make minor adjustments to the sensitivity level, with a bias toward the setting you selected.

Adjusting sensitivity in Manual Sensitivity Mode is similar to driving a car without cruise control — you have *complete* manual control of the car's speed. In this unit, manual mode allows you to set sensitivity at 100 percent (maximum) or zero percent (minimum.) Depending on water conditions, the bottom signal may completely disappear from the screen when you reduce sensitivity to about 50 percent or less!

Try adjusting sensitivity in both auto and manual modes to see how they work.

To adjust sensitivity:

1. Press **MENU | ENT**.
2. The Sensitivity Control Bar appears. Press ↓ to decrease sensitivity; press ↑ to increase sensitivity. When it's set at the desired level, press **EXIT**. (When you reach the maximum or minimum limit, a tone sounds.)

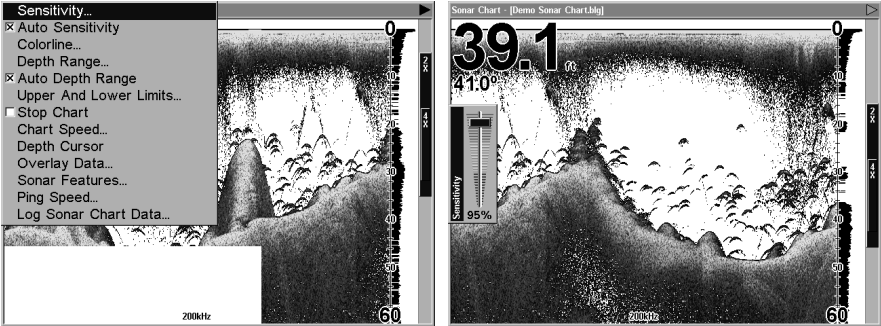

At left, Sonar Menu with Sensitivity command selected. At right, the Sensitivity Control Bar.

NOTE:

If you want to change the sensitivity in Manual Mode, first turn off Auto Sensitivity: from the Sonar Page, press **MENU | ↓** to **AUTO SENSITIVITY | ENT | ↑** to **SENSITIVITY | ENT**. Press ↓ or ↑ to pick a different sensitivity setting. When it's set at the desired level, press **EXIT**.

Important Tip:

While you are experimenting and learning, it's possible to scramble the settings so that the sonar picture disappears from your screen. If that happens, remember that it's easy to switch back to full automatic operation by simply restoring the factory auto settings. Here's how:

To Restore Factory Settings

1. Press **MENU | MENU | ↓** to **SYSTEM SETUP | ENT | ↓** to **RESET OPTIONS | ENT**.
2. The unit asks if you want to reset all the options. Press **←** to **YES | ENT**. All options are reset, and the unit reverts back to the Map Page at the 4000 mile zoom range. (Any recorded sonar logs or GPS data will be unchanged.)

Fish Symbols vs. Full Sonar Chart

You may have noticed in the quick reference that we used fish arches in full sonar chart mode for our example, and not the popular Fish I.D.[™] fish symbol feature. Here's why.

Fish I.D. *is* an easier way for a sonar novice to recognize a fishy signal return when he sees it. However, locating fish by symbol *only* has some limitations.

Your sonar unit's microprocessor is remarkably powerful, but it can be fooled. Some of the echoes *calculated* to be fish could be tree limbs or turtles! *To see what's under your boat in maximum detail, we recommend you turn off Fish I.D. and begin learning to interpret fish arches.*

Fish I.D. is most handy when you're in another part of the boat or performing some task that prevents you from watching the sonar screen. Then, you can turn on Fish I.D. and the audible fish alarm. When that lunker swims under your boat, you'll hear it!

Fish I.D. can also be useful when you want to screen out some of the sonar detail gathered by your unit. For example, in one case fisherman in San Francisco Bay saw clouds of clutter in the water but no fish arches. When a down rigger was pulled up, it brought up several small jellyfish. The fisherman switched their Lowrance sonar to Fish I.D., which screened out the schools of jellyfish and clearly showed the game fish there as fish symbols.

Other Free Training Aids

The sonar options section discusses Fish I.D., fish alarms and other features in greater detail. If you or a friend has Internet access, you can also learn more about interpreting what you see on your sonar screen. Visit our web site, **WWW.LOWRANCE.COM**. Be sure to check out the free

Sonar Tutorial, which includes animated illustrations and more pictures of actual sonar returns, all described in detail. There's even a "printer friendly" version of the tutorial available on our web site...it makes a great supplement to this operation manual!

You can also download a free copy of our Sonar Viewer software. This PC-based software application plays back any sonar chart log recorded with a Lowrance sonar product. Features include:

- Adjustable range, zoom, sensitivity, color line, noise rejection, surface clarity, etc. of the recorded file.
- Color interpretation of sonar signals can be user defined.
- Operates like a Windows Multimedia Player with forward, reverse, pause, fast forward, fast reverse, and scroll buttons.
- Adjustments update the entire record displayed
- Can print in full color.
- Window can dynamically be sized on your monitor.
- Mouse cursor shows GPS position, depth and sounding number anywhere on the visible record.

For the ultimate training aid, be sure to download the free emulator software for your unit. Aside from being just plain fun, this program can help you learn both basic and advanced operations without burning boat fuel! Lowrance is the first sonar manufacturer to provide this type of training tool for customers.

This PC application simulates the actual sonar/GPS unit on your computer. You can run it from your computer keyboard or use your mouse to press the virtual keys. Easy download and installation instructions are available on our web site.

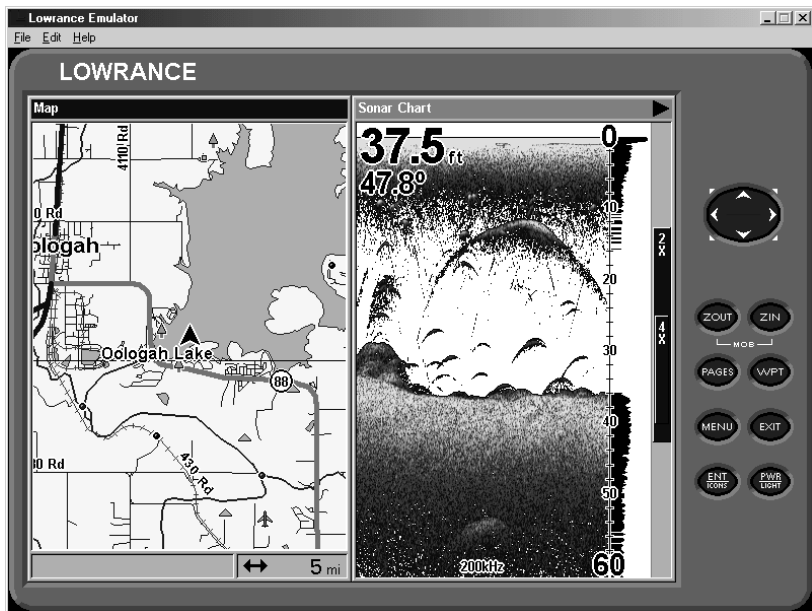

Free training emulator is available for your unit on our web site.

The emulator works exactly like your real sonar/GPS unit. Using the Sonar Simulator and GPS Simulator features, it allows you to play back sonar logs, run GPS routes and trails, even create real waypoints you can use in the field! You can even take snapshots of the Sonar Chart and print them or e-mail them to friends.

Section 4:

Sonar Options & Other Features

Material in this section is arranged in alphabetical order.

ASP™ (Advanced Signal Processing)

The ASP™ feature is a noise rejection system built into the sonar unit that constantly evaluates the effects of boat speed, water conditions and interference. This automatic feature gives you the best display possible under most conditions.

The ASP feature is an effective tool in combating noise. In sonar terms, noise is any undesired signal. It is caused by electrical and mechanical sources such as bilge pumps, engine ignition systems and wiring, air bubbles passing over the face of the transducer, even vibration from the engine. In all cases, noise can produce unwanted marks on the display.

The ASP feature has four settings — Off, Low, Medium and High. If you have high noise levels, try using the "High" ASP setting. However, if you are having trouble with noise, we suggest that you take steps to find the interference source and fix it, rather than continually using the unit with the high ASP setting.

There are times when you may want to turn the ASP feature off. This allows you to view all incoming echoes before they are processed by the ASP feature.

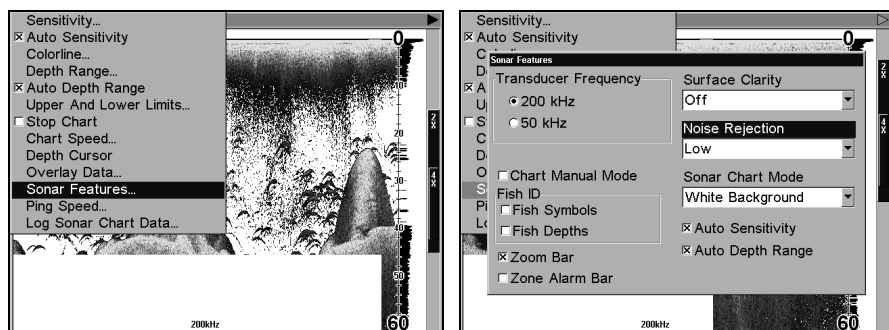

At left, Sonar Menu with Sonar Features selected. In the Sonar Features menu, Noise Rejection is selected with ASP in the default low setting.

To change the ASP level:

1. From the Sonar Page, press **MENU** | ↓ to **SONAR FEATURES** | **ENT**.
2. Press → ↓ or ↓ to **NOISE REJECTION** | **ENT**.
3. Press ↓ or ↑ to select a setting, then press **ENT**.
4. To return to the previous page, press **EXIT** | **EXIT**.

Alarms

This unit has three different types of sonar alarms. The first is the Fish Alarm. It sounds when the Fish I.D.™ feature determines that an echo is a fish.

Another alarm is the Zone Alarm, which consists of a bar on the side of the screen. Any echo on the chart that appears inside this bar triggers this alarm.

The last alarm is the Depth Alarm, which has both a Shallow and a Deep setting. Only the bottom signal will trigger this alarm. This is useful as an anchor watch, a shallow water alert or for navigation.

Depth Alarms

The depth alarms sound a tone when the bottom signal goes shallower than the shallow alarm's setting or deeper than the deep alarm's setting. For example, if you set the shallow alarm to 10 feet, the alarm will sound a tone if the bottom signal is less than 10 feet. It will continue to sound until the bottom goes deeper than 10 feet.

The deep alarm works just the opposite. It sounds a warning tone if the bottom depth goes deeper than the alarm's setting. Both depth alarms work only off the digital bottom depth signals. No other targets will trip these alarms. These alarms can be used at the same time or individually.

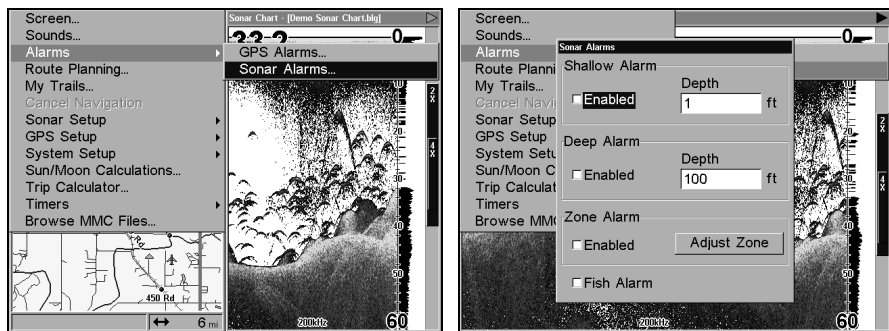

At left, Main Menu and Sonar Alarms command.

At right, the Sonar Alarms menu.

To adjust and turn on the shallow alarm:

1. Press **MENU | MENU | ↓** to **ALARMS | ENT | ↓** to **SONAR ALARMS | ENT**.
2. Press **→** to **SHALLOW ALARM DEPTH | ENT**.
3. Press **↑** or **↓** to change the first number, then press **→** to move the cursor to the next number and repeat until the depth is correct, then press **ENT**.

4. Press ← to **SHALLOW ALARM ENABLED** | ENT | EXIT | EXIT | EXIT.

5. To turn off the alarm, press **MENU** | **MENU** | ↓ to **ALARMS** | ENT | ↓ to **SONAR ALARMS** | ENT | ENT | EXIT | EXIT | EXIT.

To switch to a different depth setting, open the Sonar Alarms menu and repeat the instructions in step 3 above.

To adjust and turn on the deep alarm:

1. Press **MENU** | **MENU** | ↓ to **ALARMS** | ENT | ↓ to **SONAR ALARMS** | ENT.

2. Press ↓ to **DEEP ALARM ENABLED** | → to **DEEP ALARM DEPTH** | ENT.

3. Press ↑ or ↓ to change the first number, then press → to move the cursor to the next number and repeat until the depth is correct, then press **ENT**.

4. Press ← to **DEEP ALARM ENABLED** | ENT | EXIT | EXIT | EXIT.

5. To turn off the alarm, press **MENU** | **MENU** | ↓ to **ALARMS** | ENT | ↓ to **SONAR ALARMS** | ENT | ↓ to **DEEP ALARM ENABLED** | ENT | EXIT | EXIT | EXIT.

To switch to a different depth setting, open the Sonar Alarms menu and repeat the instructions in step 3 above.

Zone Alarm

The zone alarm is triggered when any echo passes inside the zone alarm bar, shown on the right side of the screen.

To adjust and turn on the zone alarm:

1. Press **MENU** | **MENU** | ↓ to **ALARMS** | ENT | ↓ to **SONAR ALARMS** | ENT.

2. Press ↓ to **ZONE ALARM ENABLED** | → to **ADJUST ZONE** | ENT.

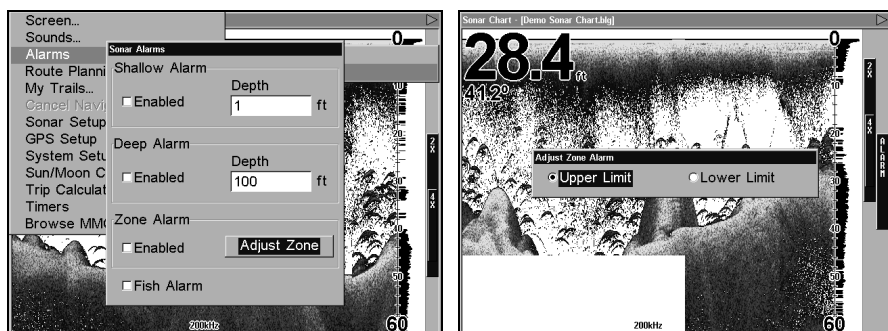

At left, Sonar Alarms menu, with Adjust Zone command selected.

At right, Adjust Zone Alarm selection box, with Upper Limit selected.

3. To set the upper boundary for the Zone Alarm, use ← or → to select **UPPER**, then press ↑ or ↓ to move the top of the bar to the desired depth.

4. To set the lower boundary for the Zone Alarm, use ← or → to select **LOWER**, then press ↑ or ↓ to move the bottom of the bar to the desired depth.

5. Press **EXIT** | ← to **ZONE ALARM ENABLED** | **ENT** | **EXIT** | **EXIT** | **EXIT**. Now, any echo — fish, bottom, structure — within the zone alarm's depth range will trigger the zone alarm.

6. To turn off the alarm, press **MENU** | **MENU** | ↓ to **ALARMS** | **ENT** | ↓ to **SONAR ALARMS** | **ENT** | ↓ to **ZONE ALARM ENABLED** | **ENT** | **EXIT** | **EXIT** | **EXIT**.

To switch to a different depth setting, open the Sonar Alarms menu and repeat the instructions in steps 3 and 4 above.

Fish Alarm

Use the fish alarm for a distinctive audible alarm when fish or other suspended objects are detected by the Fish I.D.™ feature (Fish I.D. must be turned on for the Fish Alarm to work). A different tone sounds for each fish symbol size shown on the display.

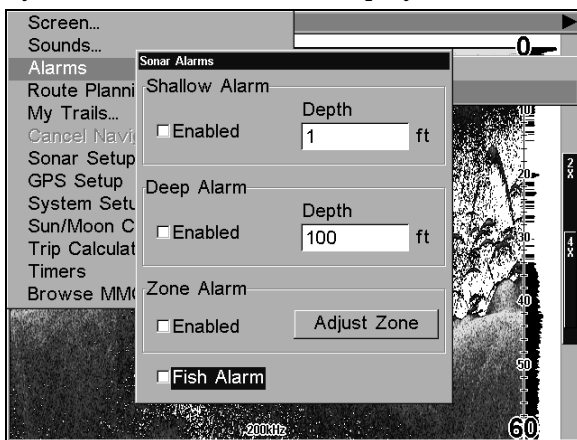

Sonar Alarms menu with Fish Alarm selected. The check box to the left is blank, indicating the alarm is turned off.

To turn the fish alarm on:

1. Press **MENU** | **MENU** | ↓ to **ALARMS** | **ENT** | ↓ to **SONAR ALARMS** | **ENT**.
2. Press ↓ to **FISH ALARM** | **ENT** | **EXIT** | **EXIT** | **EXIT**.
3. To turn off the alarm, press **MENU** | **MENU** | ↓ to **ALARMS** | **ENT** | ↓ to **SONAR ALARMS** | **ENT** | ↓ to **FISH ALARM** | **ENT** | **EXIT** | **EXIT** | **EXIT**.

Calibrate Speed

The speed sensor can be calibrated to compensate for inaccuracies. Before you change the setting, first calculate the percentage that the speed is off. You will enter this percentage in a moment.

For example, if you figure the sensor is reading 10 percent faster than actual speed, you will enter - 10 in the calibration window. If the sensor is reading 5 percent slower than true speed, you will enter + 5 in the window.

A good way to gauge your speed sensor's performance is to compare its reading with the ground speed measured by your unit's GPS functions. When you make a run to compare GPS ground speed to speed sensor speed, perform your test in relatively calm water free of current, if possible. (Unless, of course, you are taking the current speed into consideration when making your calculation.) After you have a correction figure, here's how to enter it:

1. Press **MENU|MENU|↓** to **SONAR SETUP|ENT|↓** to **CALIBRATE WATER SPEED|ENT**.
2. Enter the number you calculated earlier: press **↑** or **↓** to change the first character (+ or -), then press **→** to move the cursor to the next number and repeat until the percentage is correct, then press **EXIT**.

Chart Speed

The rate that echoes scroll across the screen is called the chart speed. The default is maximum; we recommend that you leave the speed set there for virtually all fishing conditions.

However, you might consider experimenting with chart speed when you are stationary or drifting very slowly. You may sometimes achieve better images as you slow down the chart speed to match how fast you are moving across the bottom.

If you are at anchor, ice fishing or fishing from a dock, experiment with a chart speed around 50 percent. If you are drifting slowly, try a chart speed around 75 percent. When you are stationary and a fish swims through the sonar signal cone, the image appears on the screen as a long line instead of a fish arch. Reducing the chart speed may result in a shorter line that more closely resembles a regular fish return.

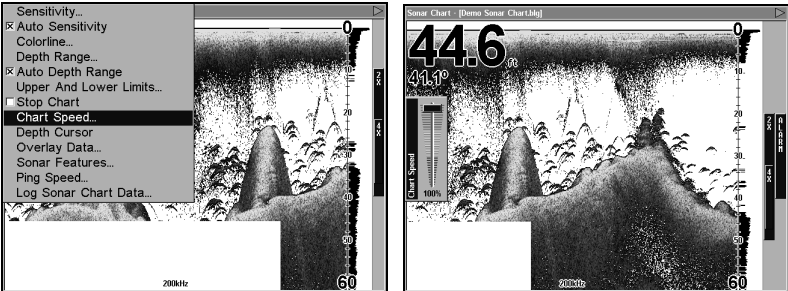

At left, Sonar Page menu with Chart Speed command selected.
At right, Chart Speed Control Bar.

If you do experiment with chart speed, remember to reset it to maximum when you resume trolling or moving across the water at higher speed. To change chart speed:

1. From the Sonar Page, press **MENU** | ↓ to **CHART SPEED** | **ENT**.
2. The Chart Speed Control Bar appears. Press ↓ to decrease chart speed; press ↑ to increase chart speed.
3. When it's set at the desired level, press **EXIT**.

ColorLine™

ColorLine lets you distinguish between strong and weak echoes. It "paints" a brighter color on targets that are stronger than a preset value. This allows you to tell the difference between a hard and soft bottom. For example, a soft, muddy or weedy bottom returns a weaker signal which is shown with a narrow, colored line (dark blue tinged with red or a little yellow.) Since fish are among the weakest echoes, they show up mostly as blue arches. A hard bottom or other relatively hard target returns a strong signal which causes a wider brightly colored line (reddish yellow to bright yellow.)

If you have two signals of equal size, one with red to yellow color and the other without, then the target with brighter color (yellow) is the stronger signal. This helps distinguish weeds from trees on the bottom, or fish from structure.

ColorLine is adjustable. Experiment with your unit to find the ColorLine setting that's best for you.

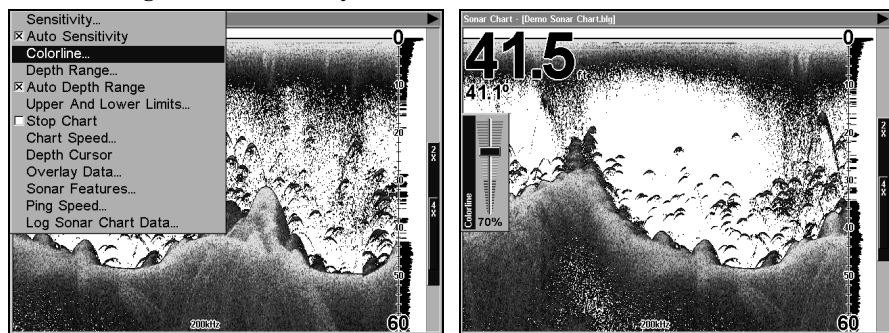

At left, Sonar Page menu with ColorLine command selected.
At right, the ColorLine control bar.

To adjust the ColorLine level:

1. From the Sonar Page, press **MENU** | ↓ to **COLORLINE** | **ENT**.
2. The ColorLine Control Bar appears. Press ↓ to decrease ColorLine; press ↑ to increase Colorline.
3. When it's set at the desired level, press **EXIT**.

Fig. 1A

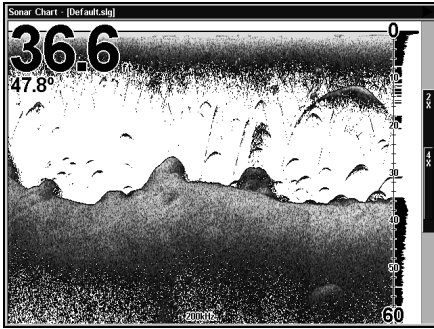

Fig. 2A

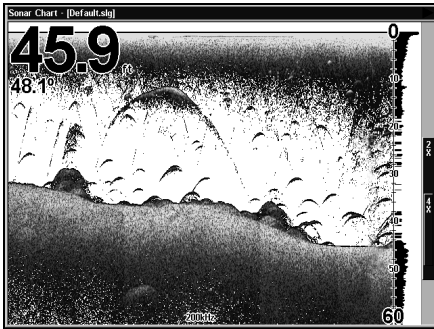

Fig. 3A

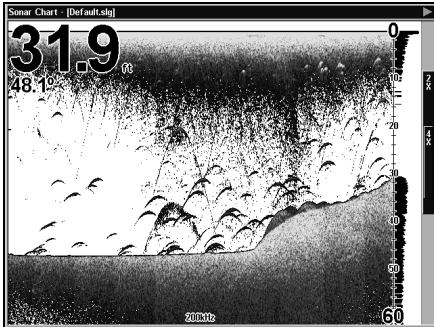

Fig. 1B

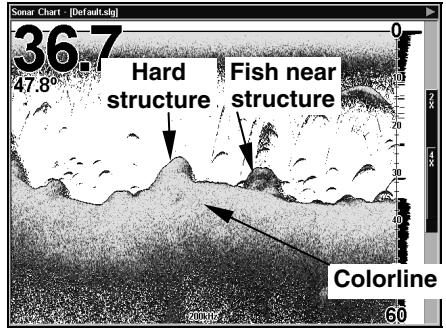

Fig. 2B

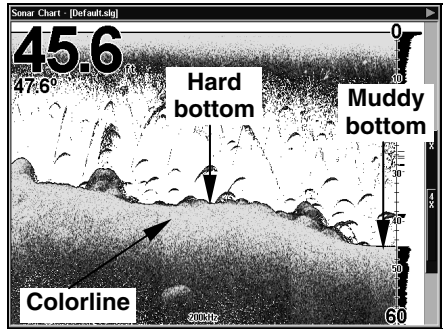
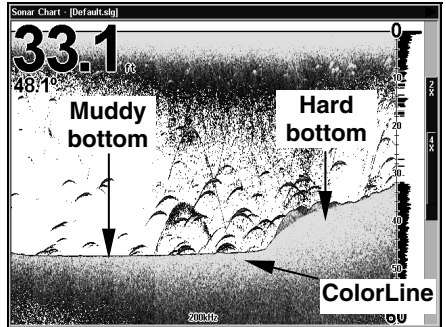

Fig. 3B



This series of figures shows how different ColorLine settings can reveal more information. The "A" figures to the left show locations with ColorLine set at the factory level of 70 percent. At right, the "B" figures show the same locations with ColorLine increased to 84 percent. In Figure 1B, no fish are near the left structure, but the right structure shows fish holding next to the structure. Notice in figures 2B and 3B how ColorLine displays a hard, rocky bottom (the drop-offs) with a wider yellow line. (The yellow is gray in this black and white illustration.) The muddier bottom below those drop-offs appears as a narrower yellow line.

Depth Cursor

The depth cursor consists of a horizontal line with a digital depth box on the right side. The numbers inside the box show the depth of the cursor.

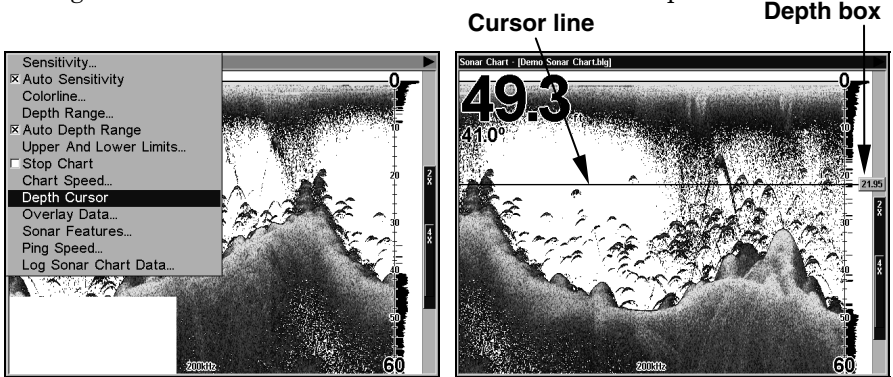

At left, Sonar Page menu with Depth Cursor command selected. At right, sonar chart with the depth cursor active. The line indicates the large fish is 21.95 feet deep.

The cursor can be moved to any location on the screen, letting you pinpoint the depth of a target.

1. From the Sonar Page, press **MENU** | ↓ to **DEPTH CURSOR** | **ENT**.
2. The depth cursor appears. Press ↓ to lower the cursor line; press ↑ to raise the cursor line.
3. To clear the depth cursor, press **EXIT**.

Depth Range - Automatic

When turned on for the first time, the bottom signal is automatically placed in the lower half of the screen. This is called Auto Ranging and is part of the automatic function. However, depending upon the bottom depth and the current range, you can change the range to a different depth. To do this:

1. From the Sonar Page, press **MENU** | ↓ to **DEPTH RANGE** | **ENT**.

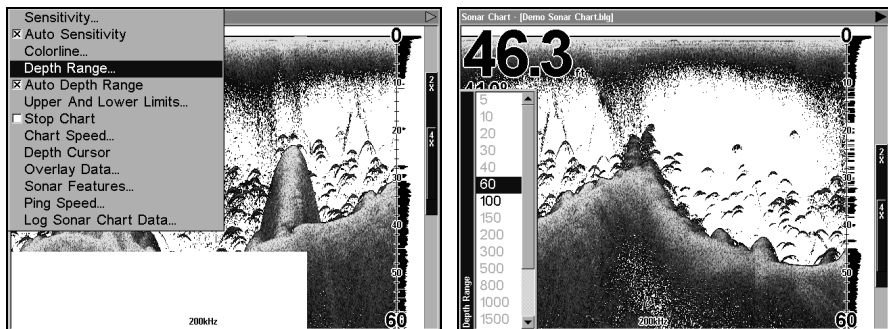

At left, Sonar Page menu with Depth Range command selected. At right, the Depth Range Control Scale.

2. The Depth Range Control Scale appears. Press \uparrow or \downarrow to select a different depth range. A black bar highlights the selected range. Range numbers in gray cannot be selected.

3. When the new range is selected, press **EXIT** to clear the menu.

Depth Range - Manual

You have complete control over the range when the unit is in the manual mode. There are 16 depth ranges, from 5 feet to 4,000 feet.

To switch to Manual Depth Range:

1. First, turn off automatic depth range. From the Sonar Page, press **MENU** | \downarrow to **AUTO DEPTH RANGE** | **ENT**.
2. Press \uparrow to **DEPTH RANGE** | **ENT** and the Depth Range Control Scale appears.
3. Press \downarrow or \uparrow to select a different depth range. A horizontal black bar highlights the selected range.
4. When the new range is selected, press **EXIT** to clear the menu.

To turn Auto Depth Range on again:

From the Sonar Page, press **MENU** | \downarrow to **AUTO DEPTH RANGE** | **ENT** | **EXIT**.

NOTE:

The sonar's depth capability depends on the transducer installation, water and bottom conditions, and other factors.

Depth Range - Upper and Lower Limits

Virtually any segment of the water column can be displayed by using the upper and lower limit feature. This lets you pick the shallow and deep depth range limits that are shown on the screen, provided there is at least 10 feet between the upper and lower limit you select. For example, a range from 12 feet to 34 feet could be used.

Changing the upper and lower limits gives you far greater control over the depth range. This feature lets you "zoom in" the display in almost unlimited combinations. Nearly any segment of the water column, from the surface to the bottom can be shown. This enlarges the sonar targets to best suit your fishing needs and water conditions.

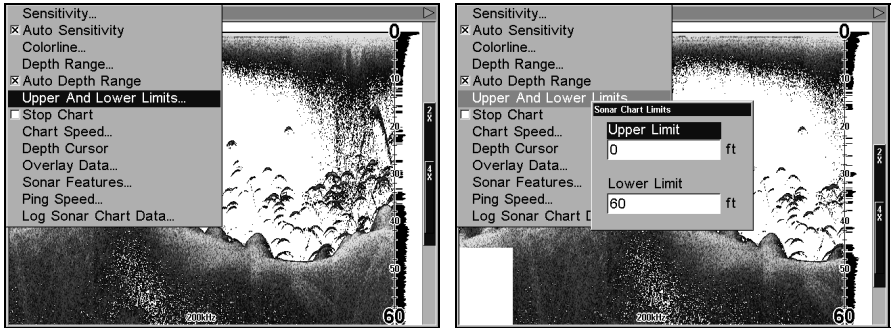

At left, Sonar Page Menu with Upper and Lower Limits command selected. At right, Sonar Chart Limits menu, with Upper Limit selected.

To change the upper and lower limits:

1. From the Sonar Page, press **MENU** | ↓ to **UPPER AND LOWER LIMITS** | **ENT**. The Sonar Chart Limits menu appears, with Upper Limit selected.
2. To set the upper limit, press **ENT**. Press ↑ or ↓ to change the first number, then press → to move the cursor to the next number and repeat until the depth is correct, then press **EXIT**.
3. To set the lower limit, press ↓ to **LOWER LIMIT** | **ENT**. Press ↑ or ↓ to change the first number, then press → to move the cursor to the next number and repeat until the depth is correct, then press **EXIT** | **EXIT** | **EXIT**.

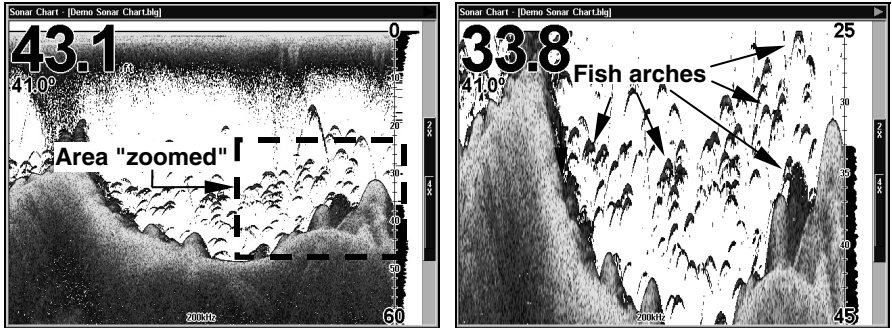

Normal display, in auto depth range mode, left. At right, display "zoomed" with Upper and Lower Limits focusing on the portion of the water column from 25 feet to 45 feet deep. In the "zoomed" image, note the target definition at the right, showing two fish holding just off the structure.

To turn off upper and lower limits:

From the Sonar Page, press **MENU** | ↓ to **AUTO DEPTH RANGE** | **ENT** | **EXIT**.

FasTrack™

This feature automatically converts all echoes to short horizontal lines on the display's far right side. The graph on the rest of the screen continues to operate normally. FasTrack gives you a rapid update of conditions directly under the boat. This makes it useful for ice fishing, or when you're fishing at anchor. When the boat is not moving, fish signals are long, drawn out lines on a normal chart display. FasTrack converts the graph to a vertical bar graph that, with practice, makes a useful addition to fishing at a stationary location.

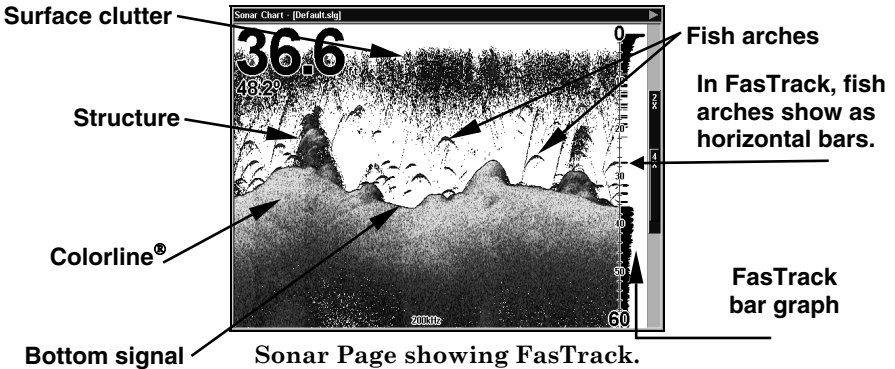

Fish I.D.™ (Fish Symbols & Depths)

The Fish I.D. feature identifies targets that meet certain conditions as fish. The microcomputer analyzes all echoes and eliminates surface clutter, thermoclines, and other signals that are undesirable. In most instances, remaining targets are fish. The Fish I.D. feature displays fish symbols on the screen in place of the actual fish echoes.

There are several fish symbol sizes. These are used to designate the relative size between targets. In other words, Fish I.D. displays a small fish symbol when it thinks a target is a small fish, a medium fish symbol on a larger target and so on.

The sonar's microcomputer is sophisticated, but it can be fooled. It can't distinguish between fish and other suspended objects such as trotlines, turtles, submerged floats, air bubbles, etc. Individual tree limbs extending outwards from a group of limbs is the hardest object for the Fish I.D. feature to distinguish from fish.

You may see fish symbols on the screen when actually, there are no fish. The reverse is also true. The illustrations on the next page show how Fish I.D. can actually *miss* fish that *are* present.

Does that mean Fish I.D. is broken? No — the feature is simply interpreting sonar returns in a specific way to help take some of the work out of reading the screen. Remember: Fish I.D. is one of the many tools we provide so you can analyze your sonar returns for maximum fish finding information. This and other features can help you successfully "see" beneath the boat under varied water and fishing conditions. So, practice with the unit in both the Fish I.D. mode and without to become more familiar with the feature. The default for Fish I.D. is off.

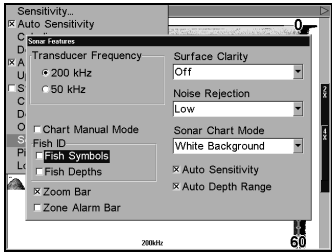

Sonar Features menu with Fish I.D. Symbols selected.

Fig. 1 A

Fig. 1 B

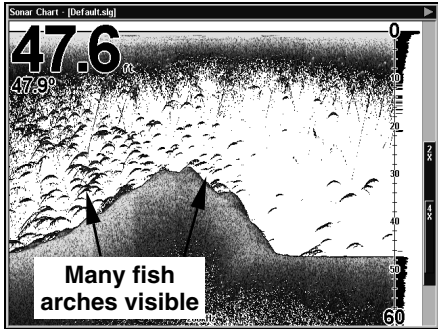

Fig. 2 A

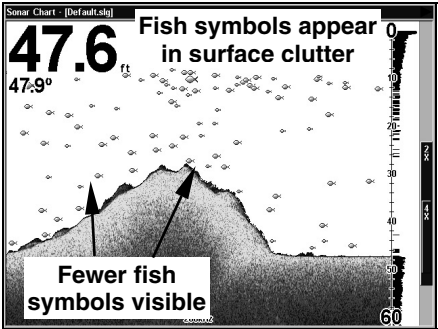
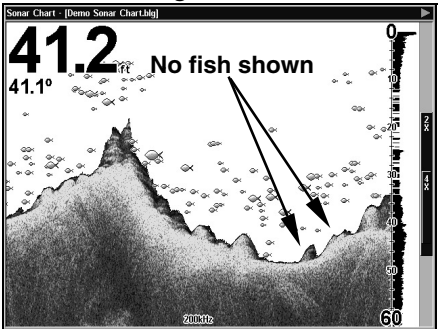
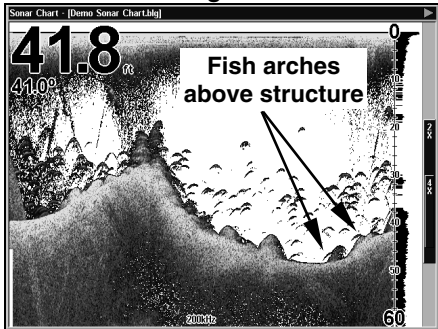

Fig. 2 B



At left, figures 1A and 2A show Sonar Page in normal chart mode. At right, figures 1B and 2B show the same underwater scene with Fish I.D. turned on. Note how arches are replaced with symbols.

To turn the Fish I.D. feature on:

1. From the Sonar Page, press **MENU** | **↓** to **SONAR FEATURES** | **ENT**.
2. Press **→** | **↓** or **→** to **FISH ID SYMBOLS** | **ENT** | **EXIT** | **EXIT**.

To turn off Fish I.D., repeat the instructions in step 1.

FishTrack™

The FishTrack feature shows the depth of a fish symbol when it appears on the display. This lets you accurately gauge the depth of targets. This feature is available only when the Fish I.D. feature is on. The default setting for FishTrack is off.

To turn on FishTrack:

(Note: These instructions will turn on FishTrack *and* Fish I.D. at the same time.)

1. From the Sonar Page, press **MENU** | **↓** to **SONAR FEATURES** | **ENT**.
2. Press **→** | **↓** to **FISH ID DEPTHS** | **ENT** | **EXIT** | **EXIT**.

To turn off FishTrack, repeat the instructions in step 1. Turning off FishTrack in this manner will not turn off Fish I.D. symbols.

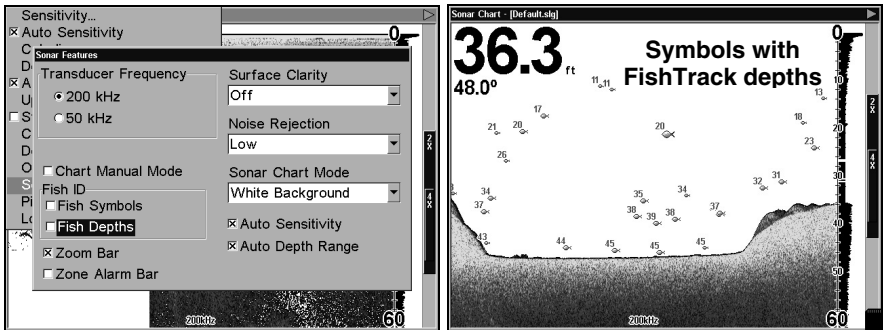

At left, Sonar Features menu with Fish I.D. Depths selected. When the check box to the left is checked, the feature is on. At right, Sonar Page showing Fish I.D. symbols and FishTrack depths turned on.

Frequency (Change Transducer Frequency) (Dual-Frequency Transducers only)

A dual-frequency transducer operates with both 200 kHz and 50 kHz. The 200 kHz frequency has a 12° cone angle and the 50 kHz frequency has a 35° cone angle.

The default frequency is 200 kHz, which is best for use in shallow water (about 300 feet or less). This frequency is the best choice for about 80 percent of the fresh and salt water sport fishing applications. When you get into very deep salt water, 300 to 500 feet or deeper, the 50 kHz frequency is the best choice.

The 200 kHz transducer will give you better detail and definition, but less depth penetration. The 50 kHz transducer will give you greater depth penetration, but a little less detail and less definition. (Remember, all sonar units typically read deeper in fresh water than in salt water.)

There is a common exception to these rules of thumb. Some fishermen on freshwater lakes (or the ocean) using downriggers like to see them on the sonar. In many of those cases, you'll see a 50 kHz transducer frequency in use because the wider cone angle lets them watch the bait.

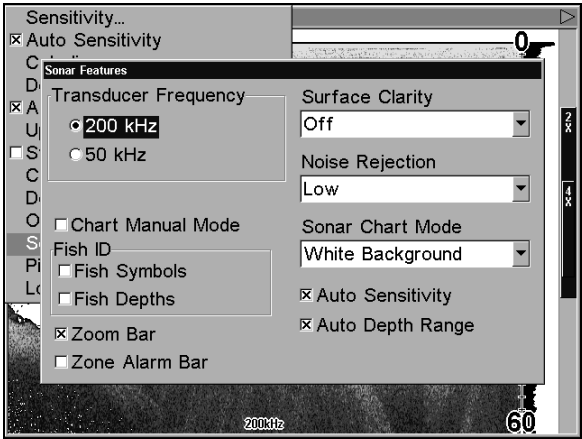

Sonar Features menu with a frequency of 200 kHz selected.

To change the frequency setting to 50 kHz:

- 1. From the Sonar Page, press **MENU** | ↓ to **SONAR FEATURES** | **ENT**.
- 2. Press ↓ to **50 kHz** | **ENT**.
- 3. Press **EXIT** | **EXIT** to clear the menu.

To change the frequency setting to 200 kHz:

- 1. From the Sonar Page, press **MENU** | ↓ to **SONAR FEATURES** | **ENT** | **ENT**.
- 2. Press **EXIT** | **EXIT** to clear the menu.

HyperScroll™

See the entry on Ping Speed, which controls the HyperScroll feature.

Log Sonar Chart Data

If you have an MMC installed in the unit, the sonar data shown on the screen can be saved to the MMC. This can be played back at any time. (To play a recorded sonar chart log, see the entry in this section for So-

nar Simulator.) If you have a personal computer and Internet access, visit our web site, www.lowrance.com, and download the free Sonar Viewer and the emulator for your unit. These programs will allow you to replay sonar logs on your personal computer.

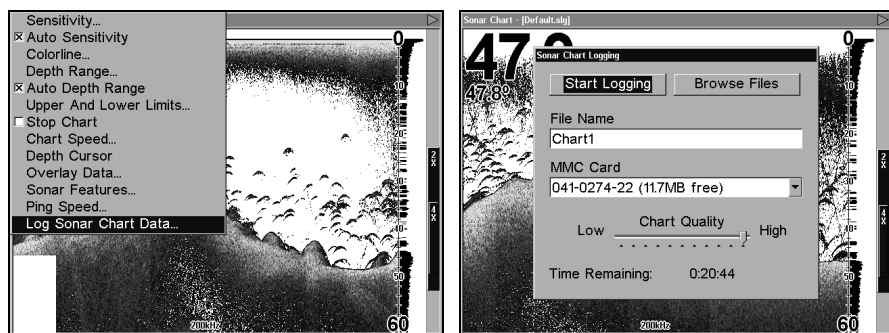

At left, the Sonar Page menu with the Log Sonar Chart Data command selected. At right, Sonar Chart Logging menu, with the Start Logging command selected. The menu says the MMC has 11.7 MB of free space, which will record the scrolling chart for 20 minutes and 44 seconds.

To record or log chart data:

1. Press **MENU** | ↓ to **LOG SONAR CHART DATA** | **ENT**.
2. To record data using the default settings, press **ENT**. The menu clears and the Sonar Page title bar shows the name of the file you are recording. Warning messages will appear as recording time begins to run out.

NOTE:

You can change any of the settings by using the cursor arrows to highlight different commands. Select **FILE NAME** if you want to change the name. Select **CHART QUALITY** if you want to lower the file quality and record for a longer period of time. After you've changed the settings, select **START LOGGING**.

Noise Rejection

See the entry on Advanced Signal Processing in this section.

Overlay Data

To change the digital data shown on top of the Sonar Page or the Map Page:

First, press **PAGES**, use → or ← to select a *Page Name*, then press **EXIT**.

To select data for display:

1. From the Map or Sonar page, press **MENU** | ↓ to **OVERLAY DATA** | **ENT**.
2. Press ↓ or ↑ to select *Data Type* | **ENT**.

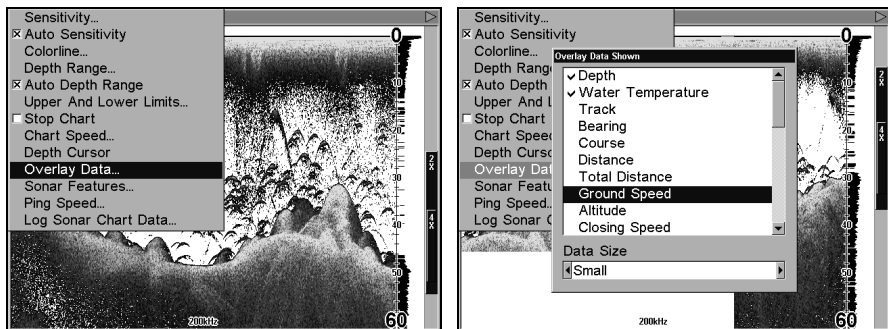

Overlay Data command on the Sonar Menu, at left. Overlay Data Shown selection menu, right. In this example, we scrolled down the data list to highlight "Ground Speed."

When selected, the data type shifts to the top of the data list and a check mark appears beside the data type. (If you wish, you may now use ↓ or ↑ to select other Data Types for display.)

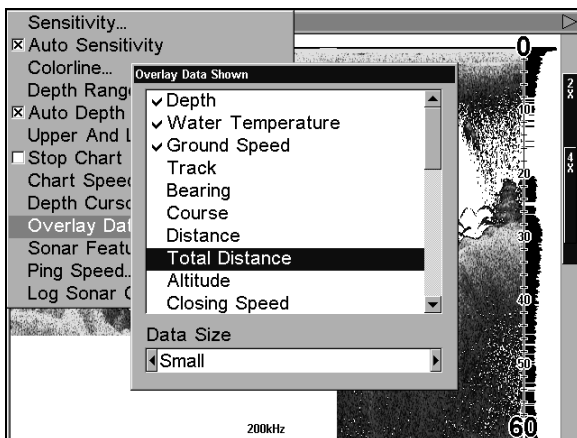

Data list showing "Ground Speed" selected to display on Sonar Page.

3. To return to the previous page, press **EXIT | EXIT**.

To turn off displayed data:

1. From the Map or Sonar page, press **MENU | ↓** to **OVERLAY DATA | ENT**.
2. Press ↓ or ↑ to select *Data Type* | **ENT**. The selected data type disappears from the top of the list and reverts to its previous, unchecked position. (If you wish, you may now use ↓ or ↑ to select other Data Types to turn off.)
3. To return to the previous page, press **EXIT | EXIT**.

To change displayed data font size:

1. From the Map or Sonar page, press **MENU | ↓** to **OVERLAY DATA | ENT**.

2. Press ↓ or ↑ to select *Data Type* | press → or ← to *Data Size* | **EXIT**.

The selected data type will be displayed in the new size. (To change the font size for another Data Type, press **ENT** and repeat these steps, beginning with step two above.)

3. To return to the previous page, press **EXIT**.

Tip:

If you wish, you can change the displayed data font size when you select a data type:

1. From the Map or Sonar page, press **MENU** | ↓ to **OVERLAY DATA** | **ENT**.

2. Press ↓ or ↑ to select *Data Type* | press → or ← to select *Data Size* | **ENT**.

The data will be shown in the new font size. To return to the previous page, press **EXIT** | **EXIT**.

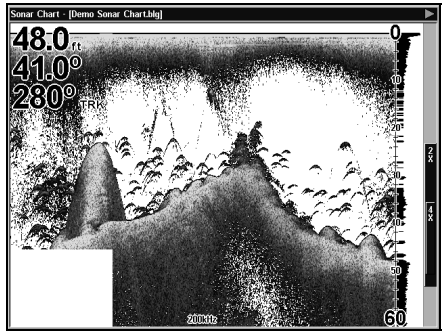
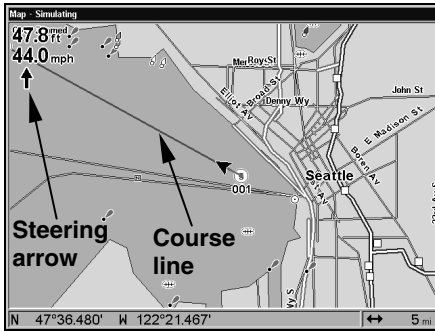

At left, Map Page showing boat cruising Puget Sound, Washington, with Overlay Data turned on. This example shows Depth, Ground Speed and the Steering Arrow. Note that the Steering Arrow always points directly to the destination you are navigating toward. In this case, the boater is headed on a northwesterly course of 280°. Since the helmsman is on course, the Steering Arrow is pointing straight ahead. If the helmsman veered off course, the arrow would show which direction to steer to get back on course toward the destination. At right, Sonar Page with Overlay Data turned on. This example shows Depth, Ground Speed and the Track the boat is following.

Ping Speed & HyperScroll™

Ping Speed controls the rate at which the transmitter and transducer broadcast sonar sound waves — pings — into the water. The unit has a default ping speed of 50 percent. At normal boating speeds, this automatically provides enough return echoes to refresh the screen and scroll the chart at maximum chart speed.

However, when you are running at high speeds, or just want the fastest possible screen update, you may want to use the HyperScroll™ feature. When you change the Ping Speed to any setting greater than 50 percent, the unit automatically enters HyperScroll mode.

These faster ping rates allow you to maintain a high-detail picture on the screen, and the screen refresh rate and chart scroll speed can keep pace with the boat as it moves quickly over the bottom terrain.

When using HyperScroll, you may also need to manually decrease the sensitivity for optimum performance. Depending on water depth and other conditions, HyperScroll may cause a second bottom echo to return to the transducer during the next ping cycle, or sounding. This can result in a large amount of clutter appearing on the screen. If this occurs, just decrease the sensitivity to a level that eliminates the clutter. When you turn HyperScroll off, you can return to your original sensitivity level.

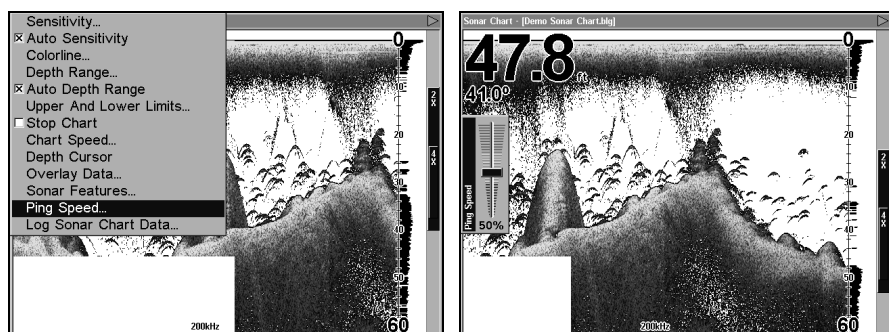

At left, Sonar Menu with Ping Speed command selected.
Ping Speed Control Bar, right, at default setting.

To change Ping Speed:

1. From the Sonar Page, press **MENU** | **↓** to **PING SPEED** | **ENT**.
2. The Ping Speed Control Bar appears. Press **↑** to increase ping speed; press **↓** to decrease ping speed. When it's set at the desired level, press **EXIT**.

To adjust Sensitivity:

1. From the Sonar Page, press **MENU** | **ENT**.
2. The Sensitivity Control Bar appears. Press **↓** to decrease sensitivity; press **↑** to increase sensitivity. When it's set at the desired level, press **EXIT**. (When you reach the maximum or minimum limit, a tone sounds.)

To turn off HyperScroll:

1. From the Sonar Page, press **MENU** | **↓** to **PING SPEED** | **ENT**.
2. The Ping Speed Control Bar appears. Press **↓** to decrease ping speed to 50 percent. When it's set at the desired level, press **EXIT**.

When you boost ping speed and switch into HyperScroll, the width of the FasTrack bar graph display doubles in width at the right side of the screen. This allows you to better see the virtually instantaneous sonar returns, just as you would on a flasher sonar unit. For more information on FasTrack, see its entry in this section.

Reset Options

This command is used to reset all features, options and settings to their original factory defaults. This is useful when you have changed several settings and want to return the unit to basic automatic operation.

1. Press **MENU | MENU | ↓** to **SYSTEM SETUP | ENT | ↓** to **RESET OPTIONS | ENT**.
2. Press **←** to **YES | ENT**.
3. All the menus are cleared and the unit reverts to the Map Page at the 4000 mile zoom range, just as if you had turned it on for the first time. All options have been returned to the factory settings.

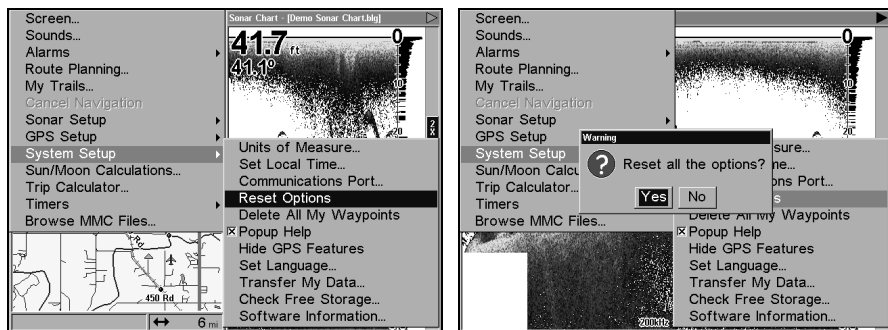

At left, System Setup menu with Reset Options command selected. At right, the Reset Options dialog box, with "Yes" selected.

NOTE:

Reset Options does *not* erase any waypoints, routes, plot trails, or sonar logs.

Reset Water Distance

The sonar chart's Digital Data display option includes a window that shows distance traveled, called Water Distance ("W Distance"). This information is calculated from an optional water speed sensor, not the GPS. The Water Distance window can be reset to zero using the Reset Water Distance command.

Press **MENU | MENU | ↓** to **SONAR SETUP | ENT | ↓** to **RESET WATER DISTANCE | ENT**. The menus are cleared and the water distance is reset to 0.00.

Set Keel Offset

This unit measures water depth from the face of the transducer. Since the transducer is installed below the water surface, the distance displayed by the digital depth, chart depth scale, chart cursor or fish symbols is *not* the exact water depth. If the transducer is 1 foot below the surface, and the screen shows the water depth as 30 feet, then the actual depth is 31 feet.

On sailboats or other large vessels with deep drafts, the distance between the transducer installation and the keel or lower engine unit can be several feet. In those cases, an inexact depth reading could result in grounding or striking underwater structure. The Keel Offset feature eliminates the need for the navigator to mentally calculate how much water is under his keel.

Keel Offset lets you calibrate the digital depth: chart depth scale, chart cursor depth and fish symbol depth displayed on the screen. To calibrate the depth indicators, first measure the distance from the face of the transducer to the lowest part of the boat. In this example, we will use 3.5 feet. This will be entered as a *negative* 3.5 feet, which makes the depth indicators perform as if the transducer's lower in the water than it really is.

1. Press **MENU | MENU | ↓** to **SET KEEL OFFSET | ENT.**
2. The Keel Offset dialog box appears. Press ↓ to change the plus (+) sign to a minus (-) sign.
3. Press → to the first number, then press ↑ to change the number to 3
4. Press → to the second number, then press ↑ to change the number to 5, then press **EXIT**. The depth indicators now accurately show the depth of water beneath the keel.

NOTE:

If knowing the exact depth of water beneath the keel is less important, you can calibrate the depth indicators so that they show the actual water depth from surface to bottom. To do this, first measure the distance from the face of the transducer up to the surface (the water line on the boat). In this example, we will use 1.5 feet. This will be entered as a *positive* 1.5 feet, which makes the depth indicators perform as if the transducer's higher in the water than it really is.

1. Press **MENU | MENU | ↓** to **SET KEEL OFFSET | ENT.**
2. The Keel Offset dialog box appears with a plus (+) sign at the front of the box.

3. Press → to the first number, then press ↑ to change the number to 1.
4. Press → to the second number, then press ↑ to change the number to 5, then press **EXIT**. The depth indicators now accurately show the water depth from surface to bottom.

Sensitivity & Auto Sensitivity

The sensitivity controls the ability of the unit to pick up echoes. Sensitivity can be adjusted, because water conditions vary greatly. A low sensitivity level (from zero to 50 percent) excludes much of the bottom information, fish signals, and other target information.

High sensitivity levels let you see this detail, but it can also clutter the screen with many undesired signals. Typically, the best sensitivity level shows a good solid bottom signal with Grayline and some surface clutter.

Automatic Sensitivity

The default sensitivity mode is automatic. The unit bases the sensitivity level on water depth and conditions. When the unit is in the automatic mode, sensitivity is automatically adjusted to keep a solid bottom signal displayed, plus a little more power. This gives it the capability to show fish and other detail.

However, situations occur when it becomes necessary to increase or decrease the sensitivity. This typically happens when you wish to see more detail, so an increase in sensitivity is indicated. Or, wave action and boat wakes can create enough tiny air bubbles to clutter much of the water column. In that case, a decrease in sensitivity is indicated to reduce some of the clutter.

The control bar used to adjust sensitivity up or down is the same whether the unit is in the automatic or manual mode. In automatic you can adjust sensitivity up to 100 percent but the unit will limit your *minimum* setting. In auto, the unit will continue to make small adjustments, allowing for the setting you selected.

In manual mode, you have *complete* control over sensitivity, with the ability to set it anywhere from zero to 100 percent. Once you select a level in manual, the unit will continue to use that exact sensitivity setting until you change it or revert to auto mode.

To adjust sensitivity in auto mode:

1. Press **MENU | ENT**.
2. The Sensitivity Control Bar appears. Press ↓ to decrease sensitivity; press ↑ to increase sensitivity. When it's set at the desired level, press **EXIT**. (When you reach the maximum or minimum limit, a tone sounds.)

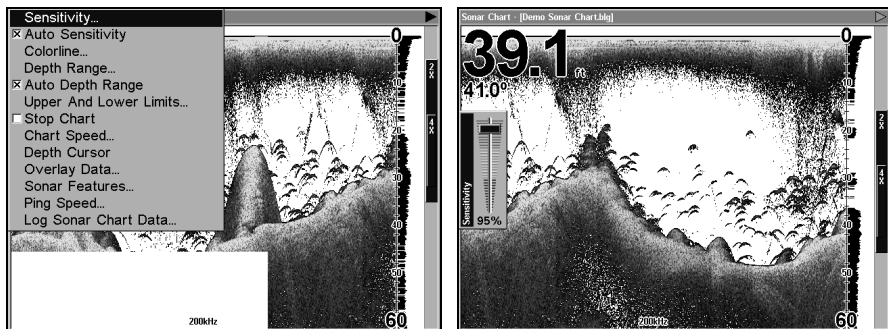

At left, Sonar Menu with Sensitivity command selected.

At right, the Sensitivity Control Bar.

To adjust sensitivity in manual mode:

1. First, turn off Auto Sensitivity: from the Sonar Page, press **MENU** | ↓ to **AUTO SENSITIVITY** | **ENT**.
2. Press ↑ to **SENSITIVITY** | **ENT** and the Sensitivity Control Bar appears. Press ↓ or ↑ to pick a different sensitivity setting. When it's set at the desired level, press **EXIT**.

To turn Auto Sensitivity back on:

From the Sonar Page, press **MENU** | ↓ to **AUTO SENSITIVITY** | **ENT** | **EXIT**.

NOTE:

To return to the original factory setting for Auto Sensitivity, see the entry in this section on Reset Options. If sensitivity is in manual mode, the Reset Options command will switch back to Auto and reset the factory setting at the same time.

Tip:

For quicker sensitivity adjustments, try leaving the Sensitivity Control Bar on the screen as the chart scrolls. You can see the changes on the screen as you press the up or down arrows. This is handy when there's a lot of clutter in the water, and you are matching the sensitivity to rapidly changing water conditions.

Sonar Color Mode

The default color scheme for the sonar chart is white background, but we offer other variations to suit your viewing preferences. You can select the chart to be displayed in grayscale, reverse grayscale, blue background, or bottom color tracking.

To change the chart mode color scheme:

1. From the Sonar Page, press **MENU** | ↓ to **SONAR FEATURES** | **ENT**.
- 2.. Press → | ↓ to **SONAR COLOR MODE** | **ENT**.

3. Press ↓ or ↑ to *Mode Name* | **ENT**.

4. Press **EXIT** | **EXIT** to return to the Sonar Page.

Sonar Page & Sonar Chart Display Options

The Pages Menu offers five chart display options for units with dual-frequency transducers and four options for units with single-frequency transducers. To access them, press **PAGES** | ← or → to **SONAR** | ↓ to *Option Name* | **EXIT**.

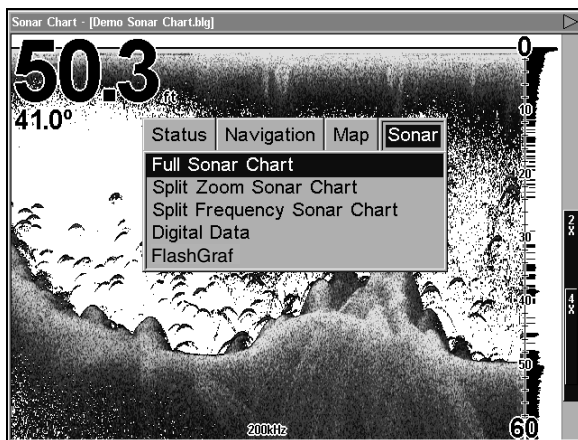

Pages Menu, showing sonar chart display options.

Full Sonar Chart

This is the default mode used when the unit is turned on for the first time or when it's reset to the factory defaults.

The bottom signal scrolls across the screen from right to left. Depth scales on the right side of the screen aid in determining the depth of targets. The line at the top of the screen represents the surface. The bottom depth and surface temperature (if equipped with a temperature sensor or a transducer with a temp sensor built in) show at the top left corner of the screen.

The FasTrack™ display shows just to the right of the scale. This changes all echoes into short horizontal bars, replicating a flasher sonar. The zoom bar on the far right shows the area that's zoomed when the zoom is in use. (See the Zoom section for more information.)

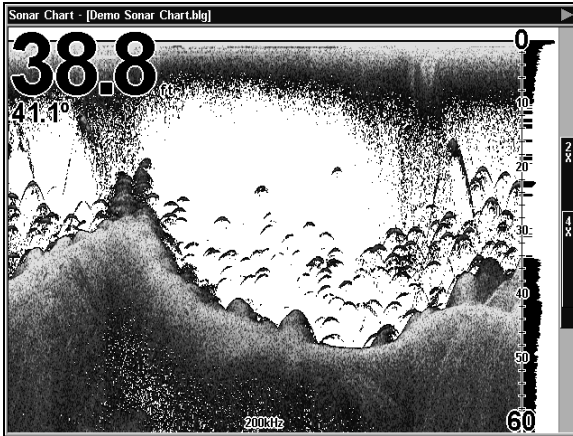

Full Sonar Chart. The Overlay Data (depth and water temperature) are each set to a different text size.

Split Zoom Sonar Chart

A split chart shows the underwater world from the surface to the bottom on the right side of the screen. The left side shows an enlarged version of the right side. The zoom range shows at the bottom left corner of the screen.

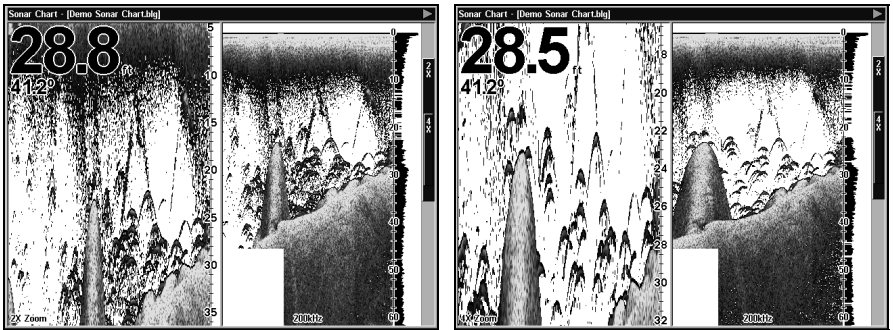

Split Zoom Sonar Chart. Image at left shows the left window zoomed to 2X. The right image shows the left window zoomed to 4X. The depth overlay data is set to the default large text size; the water temperature is set to the small text size.

Split Frequency Sonar Chart (Dual-Frequency Transducers only)

This page shows sonar data from the 50 kHz transducer element on the left side of the screen and data from the 200 kHz transducer on the right side. All other functions and features are the same as the Full Chart page.

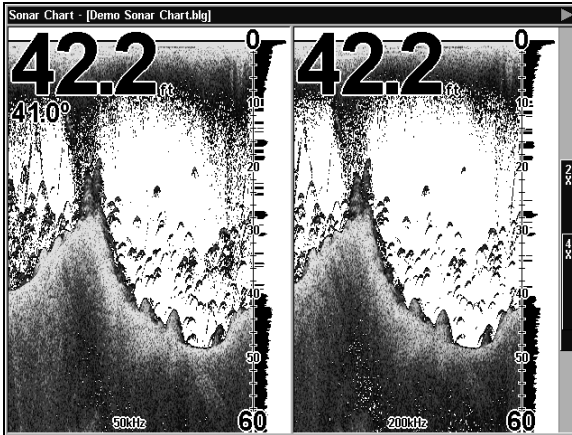

Split Frequency Sonar Chart page, with 50 kHz view at left and 200 kHz view at right.

You can adjust the sensitivity in each window.

To adjust sensitivity in auto mode:

1. Press **MENU | ENT**.
2. The unit asks which you wish to adjust. Press **←** or **→** to select the one you want | **ENT**.
3. The Sensitivity Control Bar appears. Press **↓** to decrease sensitivity; press **↑** to increase sensitivity. When it's set at the desired level, press **EXIT**. (When you reach the maximum or minimum limit, a tone sounds.)

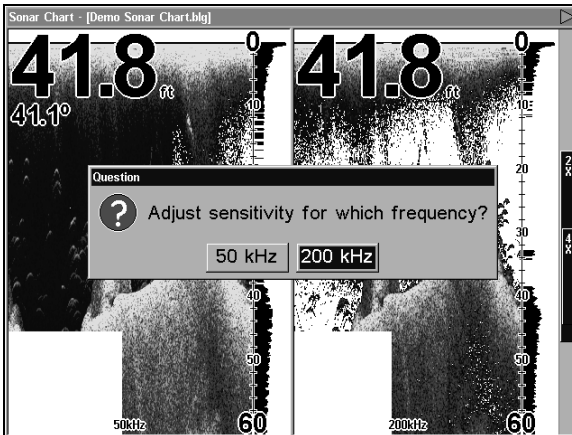

The Split Frequency Sonar Chart page allows you to adjust sensitivity separately for each window.

Digital Data/Chart

This mode shows the chart on the right side of the screen. The left side has seven large digital boxes or windows containing: Water Depth; Water Speed (from an optional speed sensor); Water Distance (distance traveled or logged, it also requires a speed sensor); Surface Water Temperature; Temperature #2 and #3 and the unit's Voltage. (**Note:** Temperature #2 requires an additional optional temperature sensor.) It also shows your current settings for the shallow and deep alarms.

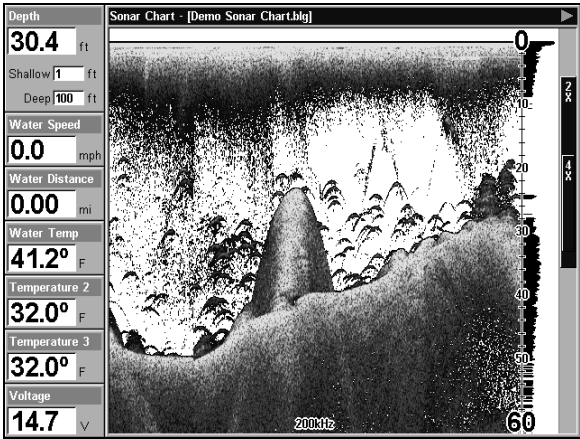

Digital Data/Chart

Customizing the Digital Data/Chart Screen

The Digital Data/Chart screen can be customized to show digital data different from the defaults first shown. To customize this screen:

1. From the Sonar Page (in Digital Data mode), press **MENU** | ↓ to **CUSTOMIZE** | **ENT**.

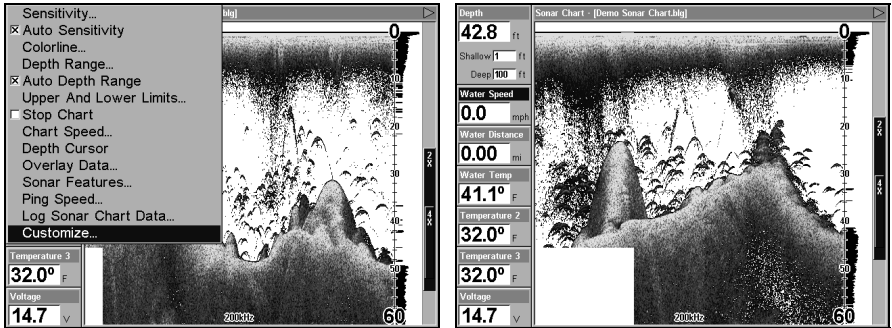

The Customize command on the Sonar Page menu.

2. The Water Speed window title bar flashes, indicating the window contents can be changed. Press **ENT**|**↑** or **↓** to select *data type* |**ENT** |**EXIT**.

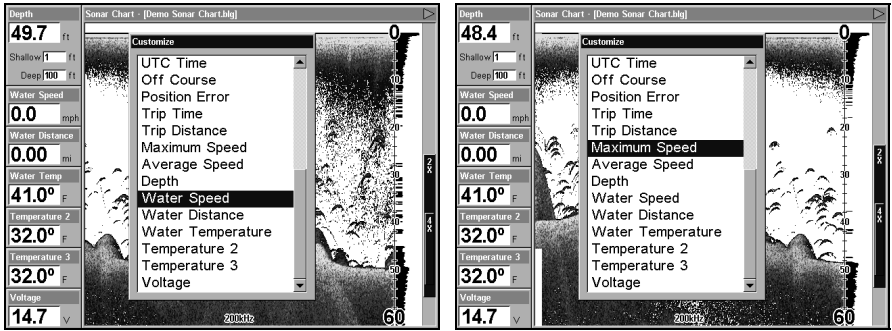

Options List for customizing Digital Data windows. At left, the list first appears with Water Speed selected. At right, Maximum Speed has been picked to replace Water Speed in the top digital data window.

Tip:

You can customize other digital data windows before returning to the Sonar Page. After changing the first window by selecting the Data Type and pressing Enter, use the **↓** key to select another window to change. When the selected window title bar flashes, press **ENT**|**↑** or **↓** to select *data type* |**ENT**. Repeat these steps until you're finished customizing, then press **EXIT** to return to the Sonar Page.

FlashGraf™

The FlashGraf sonar page option represents a flasher style sonar combined with a scrolling chart. A circular dial shows all returning echoes at a high screen refresh rate.

It uses the Colorline feature to show weaker targets as lighter colors. The bottom depth is also shown as a black bar across the outer circle. You can adjust the size of the chart and the flasher windows by using the Resize Window command, which is described on page 102.

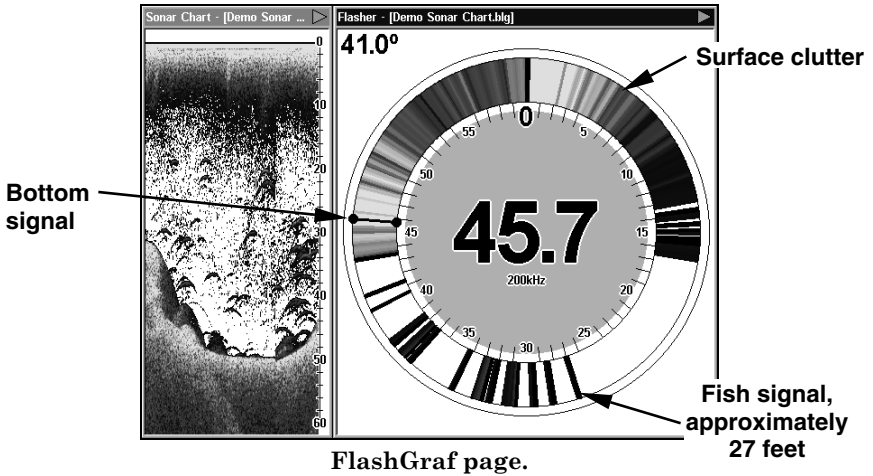

Map With Sonar Split Screen

There is a page mode that splits the screen in half, with the map on the left and the sonar on the right. This screen option can be found on the Pages Menu under the Map Page category.

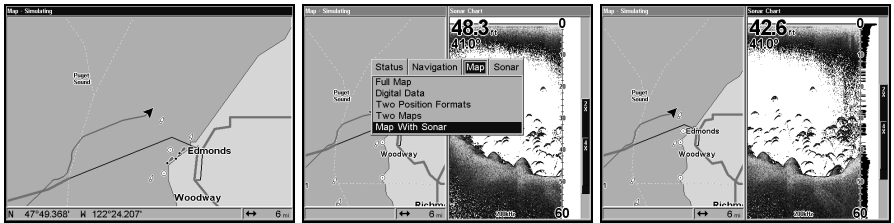

Map With Sonar split screen option. At far left, the full Map Page is shown. The Pages Menu with the Map option list is shown in the center. At right, the Map With Sonar split screen is shown.

When this screen is activated, you need to specify which side the Menu, Zoom In and Zoom Out keys correspond to. To do this, press **PAGES | PAGES**. The window with the black title bar at the top of the screen is the active window. To switch back, just press **PAGES | PAGES** again.

Sonar Simulator

This unit has a built-in simulator that lets you run it as if you were on the water. All sonar features and functions are useable. When in simulator mode, you will see the chart file name in the Sonar Page title bar and a play symbol will flash on and off at the right end of the title bar. To use the simulator:

1. From the Sonar Page, press **MENU | MENU | ↓** to **SONAR SETUP | ENT | ↓** to **SONAR SIMULATOR | ENT**.

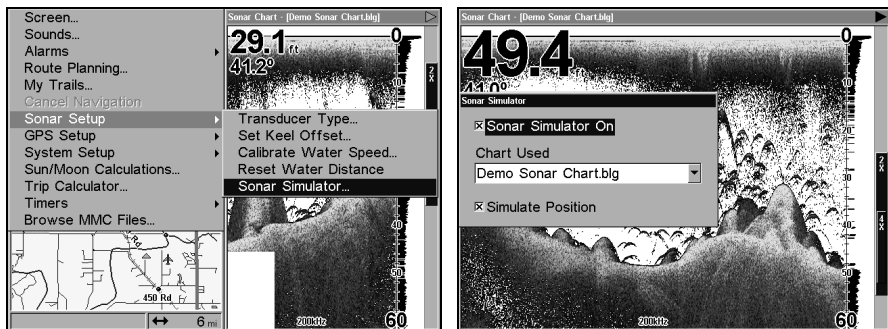

At left, Main Menu with Sonar Setup command selected. Center, sub-menu with Sonar Simulator command selected. At right, Sonar Simulator menu, with simulator turned on (checkbox is checked).

NOTE:

With Simulate Position checked, the simulator will also automatically run the GPS simulator (if GPS data was recorded with the sonar log).

2. To use the default sonar chart log stored in the unit, press **ENT | EXIT**. The recorded chart begins scrolling across the screen, just as if you were on the water.
3. Turn off Sonar Simulator by pressing **MENU | MENU | ↓** to **SONAR SETUP | ENT | ↓** to **SONAR SIMULATOR | ENT | ENT | EXIT**.

Title bar with chart file name

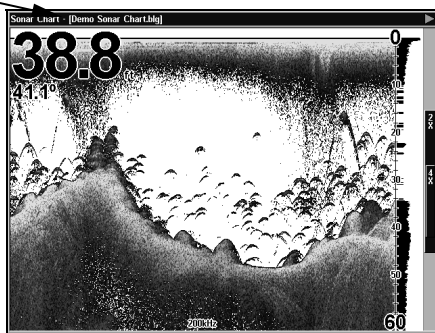

"Play" symbol flashing

Sonar Page, playing a recorded sonar chart in Sonar Simulator mode.

Tip:

The Sonar Simulator can use sonar charts that you or a friend have recorded (logged) on an MMC card. (To see how, read the entry in this section on Log Sonar Chart Data.) To play back your own sonar chart, make sure the MMC containing the chart is installed, then:

1. Press **MENU | MENU | ↓** to **SONAR SETUP | ENT | ↓** to **SONAR SIMULATOR | ENT**.
2. Press **↓** to **CHART USED | ENT**.
3. Press **↓** or **↑** to select *chart name* | **ENT | ↑** to **SONAR SIMULATOR ON | ENT | EXIT**.

While you're in the Sonar Simulator menu, don't forget to check Simulate Position if you want to run the sonar and GPS simulators simultaneously. As you review sonar logs, you can create waypoints to mark sites you want to return to.

While the simulator is running, you can switch from one chart log to another by opening the Sonar Simulator menu and using the instructions in step 2 to select a different chart.

Tip:

There's more than one way to play a recorded sonar chart. You can also turn on the simulator from the MMC files list. Here's how:

1. Press **MENU | MENU | ↓** to **BROWSE MMC FILES | ENT | ENT**.
2. Press **↓** or **↑** to *chart name* | **ENT | ↓** to **PLAY | ENT | EXIT**.

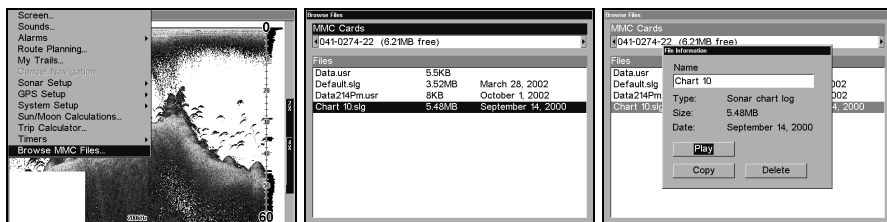

Menu sequence for playing a sonar chart log from the MMC File List.

NOTE:

For some great practice, try running the Sonar Simulator and the GPS Simulator at the same time. This will really give you a feel for how the unit will work in the field.

NOTE:

If you turn on your unit before attaching a transducer, it may enter a demo mode. The words "demo mode" flash on the bottom of the screen and a sonar chart plays much like the simulator. Unlike the simulator, the demo mode is for demonstration only, and will automatically stop as soon as you turn on the unit with a transducer attached. The simulator will continue to function normally.

Stop Chart

If you are running multiple units on a boat or using this unit in a car, there are times when you may want to turn off the sonar. This command turns off the sonar and stops the chart from scrolling. Sonar restarts automatically each time you turn on your unit.

Press **MENU** | ↓ to **STOP CHART** | **ENT** | **EXIT**.

To turn on sonar and start the chart scrolling again, repeat the above step.

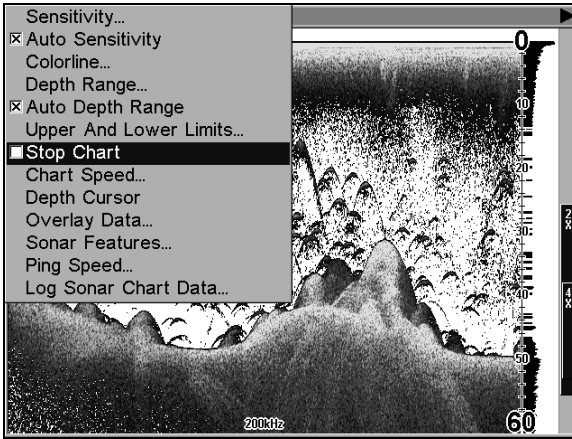

Sonar Menu with Stop Chart command selected. The box is unchecked, indicating that the chart is scrolling across the screen.

Surface Clarity

The markings extending downward from the zero line on the chart are called "surface clutter." These markings are caused by wave action, boat wakes, temperature inversion and more.

The surface clarity control reduces or eliminates surface clutter signals from the display. It does this by changing the sensitivity of the receiver, decreasing it near the surface and gradually increasing it as the depth increases.

There are three levels of surface clarity available: low, medium, or high. It can also be turned off. The default level is off.

To adjust the Surface Clarity level:

1. From the Sonar Page, press **MENU** | ↓ to **SONAR FEATURES** | **ENT**.

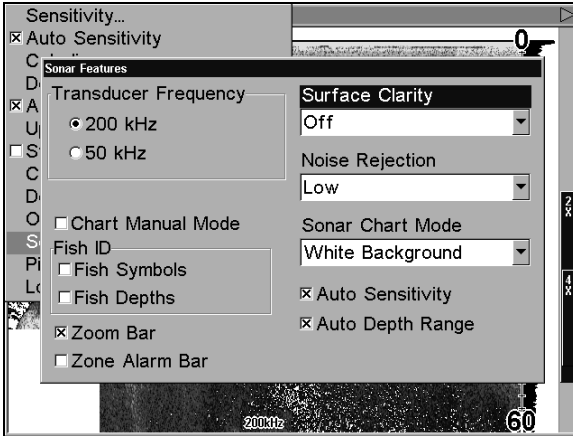

Sonar Features menu with Surface Clarity selected.

2. Press → to **SURFACE CLARITY** | ENT.
3. Press ↓ or ↑ to select *clarity level* | EXIT | EXIT | EXIT.

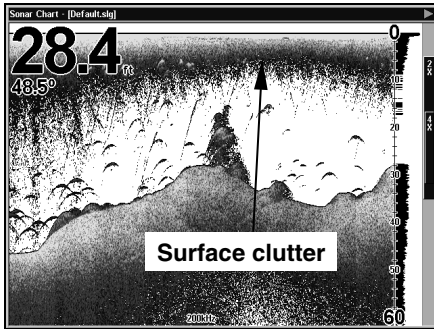

In the illustration at left, Surface Clarity is turned off. The right view shows Surface Clarity set at High.

Upper and Lower Limits

See the entry in this section for Depth Range - Upper and Lower Limits

Zoom & Zoom Bar

"Zooming" the display is a common, fast and easy method used to enlarge small detail, fish signals and the bottom with its associated structure. This unit lets you zoom the display quickly and easily by pressing the Zoom In key, **ZIN**.

Pressing **ZIN** once doubles the size (2X) of all echoes on the screen. Pressing it again quadruples the size (4X). The zoom bar on the far right side of the screen shows which echoes will be displayed on the screen when the **ZIN** key is pressed.

For example, pressing the **ZIN** key once will enable a 2X zoom which will show all echoes that are between the top and bottom of the 2X zoom bar. Pressing the key again will give a 4X zoom and only the echoes between the top and bottom of the 4X bar will show on the screen.

Press the Zoom Out key, **ZOUT**, to return the display to the normal mode.

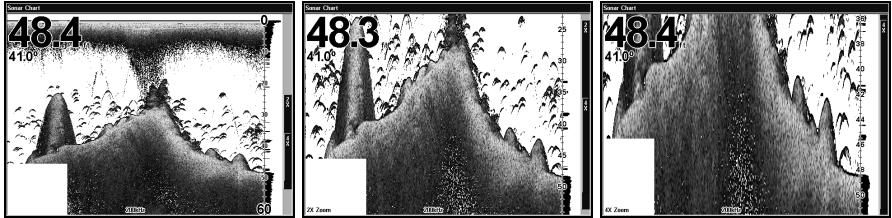

At left, Sonar Page, normal view. Center, same view zoomed to 2X.
Right, same view zoomed to 4X

Zoom Pan

Your unit has the handy ability to quickly zoom in on any portion of the water column with just the touch of an arrow key. The Zoom Pan feature lets you rapidly move the zoomed area up and down to different depths. By "pointing" your zoom at different portions of the chart as it scrolls, you can get a good, close-up look at structure or cover below you.

To use Zoom Pan, switch to a manual depth Range setting (see page 61) and turn on 2X or 4X Zoom. Then, simply press \uparrow or \downarrow to pan up and down the water column.

Notes

Section 5:

Sonar Troubleshooting

If your unit is not working, or if you need technical help, please use the following troubleshooting section before contacting the factory customer service department. It may save you the trouble of returning your unit for repair. For contact information, refer to the last page, just inside the back cover of this manual.

Unit won't turn on:

1. Check the power cable's connection at the unit. Also check the wiring.
2. Make certain the power cable is wired properly. The red wire connects to the positive battery terminal, black to negative or ground.
3. Check the fuse.
4. Measure the battery voltage at the unit's power connector. It should be at least 11 volts. If it isn't, the wiring to the unit is defective, the battery terminals or wiring on the terminals are corroded, or the battery needs charging.

Unit operates only in demo mode:

The transducer or antenna module has not yet been connected or has been disconnected. To leave demo mode, make sure that either the transducer or the antenna is securely connected before turning the unit on.

Unit freezes, locks up, or operates erratically:

1. Electrical noise from the boat's motor, trolling motor, or an accessory may be interfering with the sonar unit. Rerouting the power and transducer cables away from other electrical wiring on the boat may help. Route the sonar unit's power cable directly to the battery instead of through a fuse block or ignition switch
2. Inspect the transducer cable for breaks, cuts, or pinched wires.
3. Check both the transducer and power connectors. Make certain both are securely plugged in to the unit.

Weak bottom echo, digital readings erratic, or no fish signals:

1. Make certain the transducer is pointing straight down. Clean the face of the transducer. Oil, dirt and fuel can cause a film to form on the transducer, reducing its effectiveness. If the transducer is mounted inside the hull, be sure it is shooting through only one layer of fiberglass and that it is securely bonded to the hull. Do NOT use RTV silicone rubber adhesive or Marine-Tex™ epoxy.
2. Electrical noise from the boat's motor can interfere with the sonar.

This causes the sonar to automatically increase its Discrimination or noise rejection feature. This can cause the unit to eliminate weaker signals such as fish or even structure from the display.

3. The water may be deeper than the sonar's ability to find the bottom. If the sonar can't find the bottom signal while it's in the automatic mode, the digital sonar display will flash continuously. It may change the range to limits far greater than the water you are in. If this happens, place the unit in the manual mode, then change the range to a realistic one, (for example, 0-100 feet) and increase the sensitivity. As you move into shallower water, a bottom signal should appear.

4. Check the battery voltage. If the voltage drops, the unit's transmitter power also drops, reducing its ability to find the bottom or targets.

Bottom echo disappears at high speeds or erratic digital reading or weak bottom echo while boat is moving

1. The transducer may be in turbulent water. It must be mounted in a smooth flow of water in order for the sonar to work at all boat speeds. Air bubbles in the water disrupt the sonar signals, interfering with its ability to find the bottom or other targets. The technical term for this is cavitation.

2. Electrical noise from the boat's motor can interfere with the sonar. This causes the sonar to automatically increase its Discrimination or noise rejection feature. This can cause the unit to eliminate weaker signals such as fish or even structure from the display. Try using resistor spark plugs or routing the sonar unit's power and transducer cables away from other electrical wiring on the boat.

No fish arches when the Fish I.D. feature is off:

1. Make certain the transducer is pointing straight down. This is the most common problem if a partial arch is displayed.

2. The sensitivity may not be high enough. In order for the unit to display a fish arch, it has to be able to receive the fish's echo from the time it enters the cone until it leaves. If the sensitivity is not high enough, the unit shows the fish only when it is in the center of the cone.

3. Use the Zoom feature. It is much easier to display fish arches when zoomed in on a small range of water than a large one. For example, you will have much better luck seeing fish arches with a 30 to 60 foot range than a 0 to 60 foot range. This enlarges the targets, allowing the display to show much more detail.

4. The boat must be moving at a slow trolling speed to see fish arches. If the boat is motionless, fish stay in the cone, showing on the screen as straight horizontal lines.

NOISE

A major cause of sonar problems is electrical noise. This usually appears on the sonar's display as random patterns of dots or lines. In severe cases, it can completely cover the screen with black dots, or cause the unit to operate erratically, or not at all.

To eliminate or minimize the effects of electrical noise, first try to determine the cause. With the boat at rest in the water, the first thing you should do is turn all electrical equipment on the boat off. Make sure the engine is also off. Turn your sonar on, then turn off Noise Reject [also known as the ASP feature (Advanced Signal Processing)]. Sensitivity should be set at 90-95 percent. There should be a steady bottom signal on the display. Now turn on each piece of electrical equipment on the boat and view the effect on the sonar's display. For example, turn on the bilge pump and view the sonar display for noise. If no noise is present, turn the pump off, then turn on the VHF radio and transmit. Keep doing this until all electrical equipment has been turned on, their effect on the sonar display noted, then turned off.

If you find noise interference from an electrical instrument, trolling motor, pump, or radio, try to isolate the problem. You can usually reroute the sonar unit's power cable and transducer cable away from the wiring that is causing the interference. VHF radio antenna cables radiate noise when transmitting, so be certain to keep the sonar's wires away from it. You may need to route the sonar unit's power cable directly to the battery to isolate it from other wiring on the boat.

If no noise displays on the sonar unit from electrical equipment, then make certain everything except the sonar unit is turned off, then start the engine. Increase the RPM with the gearshift in neutral. If noise appears on the display, the problem could be one of three things; spark plugs, alternator, or tachometer wiring. Try using resistor spark plugs, alternator filters, or routing the sonar unit's power cable away from engine wiring. Again, routing the power cable directly to the battery helps eliminate noise problems. Make certain to use the in-line fuse supplied with the unit when wiring the power cable to the battery.

When no noise appears on the sonar unit after all of the above tests, then the noise source is probably cavitation. Many novices or persons with limited experience make hasty sonar installations which function perfectly in shallow water, or when the boat is at rest. In nearly all cases, the cause of the malfunction will be the location and/or angle of the transducer. The face of the transducer must be placed in a location that has a smooth flow of water at all boat speeds. Read your transducer owner's manual for the best mounting position.

Notes

Section 6: Basic GPS Operations

This section addresses the unit's *most basic* GPS operations. The tutorials presented in Sec. 6 follow a chronological order. Sec. 7, *Advanced GPS Operations*, will discuss other more advanced functions and utilities. Material in Sec. 7 is arranged in alphabetical order.

Before you turn on the Unit and find where you are, it's a good idea to learn about the different keys, the four Page screens and how they all work together. BUT, if you just can't wait to get outside, turn to the one-page **Quick Reference** on page 103.

Keyboard

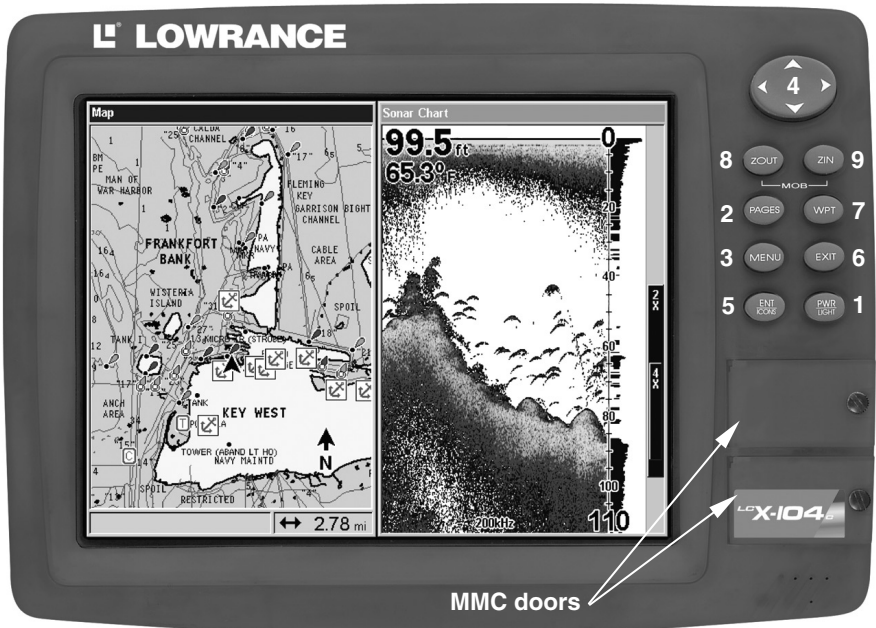

LCX-104C sonar/GPS unit, front view, showing sonar screen, keyboard and access doors for the MMC compartment.

1. **PWR/LIGHT** (Power & Light) – The PWR key turns the unit on and off and activates the backlight.
2. **PAGES** – Pressing this and the ← → arrow keys (4) switches the unit between the four different page screens. (Satellite Status Page, Navigation Page, Map Page and Sonar Page.) Each page represents one of the unit's major operation modes.

3. **MENU** – Press this key to show the menus and submenus, which allow you to select a command or adjust a feature. This also accesses search functions for streets, intersections, addresses and highway exits.

4. **ARROW KEYS** – These keys are used to navigate through the menus, make menu selections, move the map cursor and sonar chart cursor and enter data.

5. **ENT/ICONS** (Enter & Icons) – This key allows you to save data, accept values or execute menu commands. It is also used to create event marker icons.

6. **EXIT** – The Exit key lets you return to the previous screen, clear data or erase a menu.

7. **WPT** – (Waypoint) The Waypoint key is used to save and recall waypoints, search for waypoints and access the waypoint list. It also launches the Point-of-Interest (POI) search menus and is involved in some navigation functions.

8. **ZOUT** – (Zoom Out) – This key lets you zoom the screen out. On the Sonar Page, this key returns you to a full sonar chart display, showing the entire water column from surface to bottom. On the Map Page, this lets you see a larger geographic area on the map. Less detail is seen as you zoom out.

9. **ZIN** – (Zoom In) – This key lets you zoom the screen in. On the Sonar Page, this key enlarges fish signals and bottom detail. On the Map Page, zooming in lets you see greater detail in a smaller geographic area on the map.

Power/lights on and off

To turn on the unit, press **PWR**. As the unit powers up, the Map Page is displayed first. (To switch to another page, press **PAGES** |← or → to *Page Name* | **EXIT**.)

To turn on the backlight, press **PWR** again. The unit has three backlight levels to select from. Repeatedly pressing **PWR** will cycle through the backlight settings and turn off the backlight.

Turn off the unit by pressing and holding the **PWR** key for 3 seconds.

Main Menu

The Unit has a Main Menu, which contains some function commands and some setup option commands. The tutorial lessons in this section will deal only with functions, the basic commands that make the Unit do something. The unit will work fine for these lessons right out of the

box with the factory default settings. But, if you want to learn about the various options, see Sec. 8, *System Setup and GPS Setup Options*.

You can access the Main Menu from any of the four Page screens by pressing **MENU | MENU**. To clear the menu screen and return to the page display, press **EXIT**.

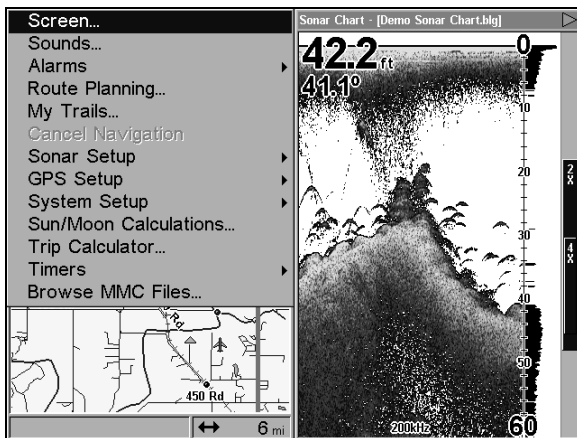

Main Menu.

The Main Menu commands and their functions are:

Screen command: changes the contrast or brightness of the display screen.

Sounds command: enables or disables the sounds for key strokes and alarms and sets the alarm style.

Alarms command: turns GPS or sonar alarms on or off and changes alarm thresholds.

Route Planning command: used to plan, view or navigate a route.

My Trails command: shows, hides, creates and deletes plot trails. Also used to navigate or backtrack a trail.

Cancel Navigation command: turns off the various navigation commands. Used to stop navigating after you have reached your destination waypoint, Point of Interest or map cursor location; or after you reach the end of a route or trail.

Sonar Setup command: sets various sonar options.

GPS Setup command: sets various GPS receiver options.

System Setup command: sets general configuration options.

Sun/Moon Calculations command: finds the rising and setting time

of the sun and the moon.

Trip Calculator command: shows trip status and statistics.

Timers command: controls the up timer, down timer and alarm clock settings.

Browse MMC Files command: this allows you to view the installed MMC card and the files it contains.

Pages

The unit has four Page displays that represent the four major operating modes. They are the Satellite Status Page, the Navigation Page, Map Page and the Sonar Page. They are accessed by pressing the **PAGES** key, then using \rightarrow or \leftarrow to select a Page. (Clear the Pages Menu by pressing **EXIT**.)

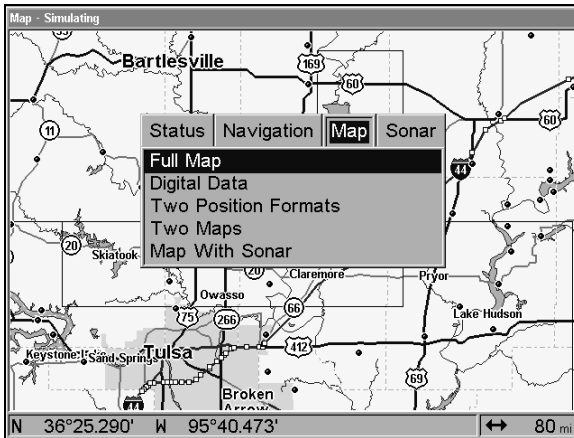

Pages Menu, showing some Map display options.

Sonar Page

The Sonar Page displays the sonar chart, a view of the water column from the surface to the bottom. The chart scrolls across the screen from right to left, displaying signal echoes that represent fish, structure and the bottom. The Sonar Page is discussed in detail in Sec. 3. To get to the Sonar Page: Press the **PAGES** key, then use \rightarrow or \leftarrow to select **SONAR**. (Clear the Pages Menu by pressing **EXIT**.)

Satellite Status Page

The Satellite Status Page, shown, provides detailed information on the status of the Unit's satellite lock-on and position acquisition. To get to the Satellite Status Page: Press the **PAGES** key, then use \rightarrow or \leftarrow to select **STATUS**. (Clear the Pages Menu by pressing **EXIT**.)

No matter what Page you are on, a flashing current position indicator/question mark symbol and flashing GPS data displays indicate that satellite lock has been lost and there is no position confirmed. The Satellite Status Page shows you the quality and accuracy of the current satellite lock-on and position calculation.

WARNING:

Do not begin navigating with this unit until the numbers have stopped flashing!

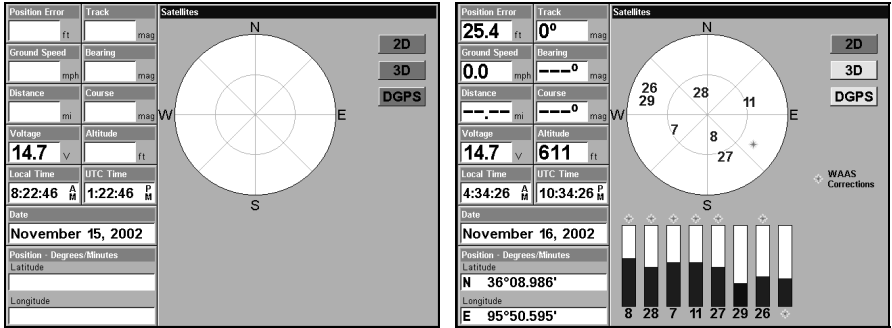

Satellite Status Page. Left view indicates unit has not locked on to any satellites and does not have a fix on its position. Right view shows satellite lock-on with a 3D position acquired (latitude, longitude and altitude), and WAAS reception.

This screen shows a graphical view of the satellites that are in view. Each satellite is shown on the circular chart relative to your position. The point in the center of the chart is directly overhead. The small inner ring represents 45° above the horizon and the large ring represents the horizon. North is at the top of the screen. You can use this to see which satellites are obstructed by obstacles in your immediate area if the unit is facing north.

The GPS receiver is tracking satellites that are in light blue. The receiver hasn't locked onto a satellite if the number is dark blue, therefore it isn't being used to solve the position.

Beneath the circular graph are the bar graphs, one for each satellite in view. Since the unit has twelve channels, it can dedicate one channel per visible satellite. The taller the bar on the graph, the better the unit is receiving the signals from the satellite.

The "Estimated Position Error" (horizontal position error) shown in the upper left corner of the screen is the expected error from a benchmark location. In other words, if the EPE shows 50 feet, then the position shown by the unit is estimated to be within 50 feet of the actual location. This also gives you an indicator of the fix quality the unit cur-

rently has. The smaller the position error number, the better (and more accurate) the fix is. If the position error flashes dashes, then the unit hasn't locked onto the satellites, and the number shown isn't valid.

The Satellite Status Page has its own menu, which is used for setting various options. (Options and setup are discussed in Sec. 8.) To access the Satellite Status Page Menu, from the Status Page, press **MENU**.

Navigation Page

This screen has a compass rose that not only shows your direction of travel, but also the direction to a recalled waypoint. To get to the Navigation Page: Press **PAGES** | → or ← to **NAVIGATION** | **EXIT**.

The navigation screen looks like the one below when you're *not* navigating to a waypoint or following a route or trail. Your position is shown by an arrow in the center of the screen. Your trail history, or path you've just taken, is depicted by the line extending from the arrow. The arrow pointing down at the top of the compass rose indicates the current track (direction of travel) you are taking.

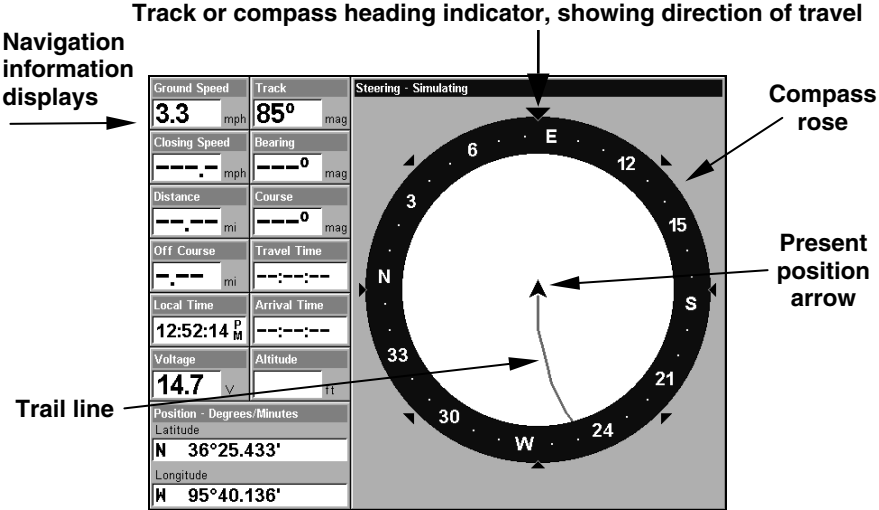

Navigation Page, recording a trail, traveling east. Page looks like this when the unit is not navigating to a waypoint, following a route, or backtracking a trail.

When navigating to a waypoint, the Navigation screen looks like the following figure. Your ground speed, track, distance and bearing to waypoint, and course are all shown digitally on this screen.

NOTE:

Remember, when the Speed, Track and Position information displays are flashing, satellite lock has not been achieved and no position fix has been determined. A question mark will also flash on the present position arrow in the center of the compass rose.

Speed (ground speed) is the velocity you are making over the ground. (If you wish, you can customize the Speed window to display Closing Speed instead. Closing Speed is also known as velocity made good. It's the speed that you're making toward the waypoint. For instructions, see the Customize Page Displays entry in Sec. 8.)

Track is the heading, or the current direction you are actually traveling. Bearing is the direction of a line-of-sight from your present position to the destination. No matter what direction you are steering, the Bearing window shows the compass direction straight to the destination from your location at the moment. Distance shows how far it is to the waypoint you're navigating toward.

The Off Course window shows the current cross track error. This shows the distance you are off-course to the side of the desired course line. The course line is an imaginary line drawn from your position when you started navigating to the destination waypoint. The course line is shown on the Navigation Page screen (and the Map Page screen) as a red line.

The cross track error range is shown on the compass rose as a wide, white, corridor enclosing the course line. The outer edges of this white corridor represent lines that show the current cross track error range. The default for the cross track error range is 0.20 miles.

For example, if the present position symbol touches the right cross track error line, then you are 0.20 miles to the right of the desired course. You need to steer left to return to the desired course. You can use the **ZIN** or **ZOUT** keys to change the cross track error range.

A circular symbol depicting your destination (waypoint) appears on the screen as you approach the waypoint, as shown on the screen in the following figure.

Travel Time is the time that it will take to reach your destination at your present closing speed. (You can also customize the time window to show Arrival Time instead. Arrival Time is the local time it will be when you arrive at the destination, based upon your present closing speed and track.)

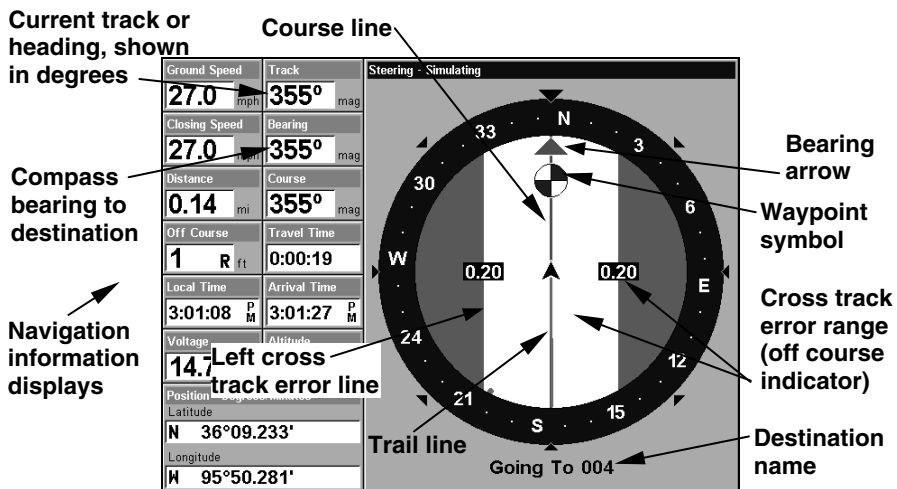

Navigation Page, backtracking a trail while creating a new trail.

In the example figure above, the driver is headed north (a 355° track) toward a waypoint 355° (bearing) away. The cross track error range (white corridor) is 0.20 miles either side of the course. The driver is headed toward trail waypoint 4, which is 0.14 miles away. The vehicle is virtually on course (off course 1 foot to the right). Traveling at a speed of 27 mph, the driver will arrive at the waypoint in 19 seconds.

The Navigation Page has its own menu, which is used for some advanced functions and for setting various options. (Options and setup are discussed in Sec. 8.) To access the Navigation Page Menu, from the Navigation Page, press **MENU**.

Map Page

The Map Page screens show your course and track from a "bird's-eye" view. By default, this unit shows the map with north always at the top of the screen. (This can be changed. See the topic *Map Orientation*, in Sec. 8.) If you're navigating to a waypoint, the map also shows your starting location, present position, course line and destination. You don't have to navigate to a waypoint, however, to use the map.

Map Page is the default screen that appears when you turn on the unit. To get to the Map Page from another page: Press **PAGES** | → or ← to **MAP** | **EXIT**. When the Map Page is displayed, a screen similar to the following figures appears.

The arrow in the center of the screen is your present position. It points in the direction you're traveling. The magenta line extending from the back of the arrow is your plot trail, or path you've taken.

The map zoom range is the distance across the screen. This number shows in the lower right corner of the screen. In the first example figure below, the range is 4,000 miles from the left edge of the map to the right edge of the map.

The Zoom In and Zoom Out keys zoom the map to enlarge or reduce its coverage area and the amount of mapping detail shown. There are 37 available map zoom ranges, from 0.05 miles to 4,000 miles.

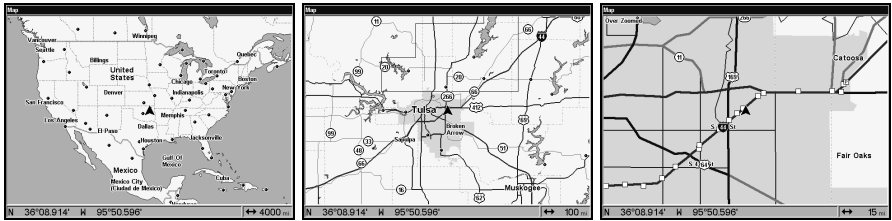

Far left, Map Page opening screen. Center, zoomed to 100 miles and right, zoomed to 15 miles. Over Zoomed means you have reached the detail limits in an area covered only by the basic background map. Zooming in any closer will reveal no more map details because a high-detail custom map has not been loaded on the MMC for this area.

If you're using only the factory-loaded background map, the maximum zoom range for showing *additional* map detail is 20 miles. You can continue to zoom in closer, but the map will simply be enlarged without revealing more map content (except for a few major city streets.) Load your own high-detail custom map made with MapCreate, and you can zoom in to 0.05 miles with massive amounts of accurate map detail.

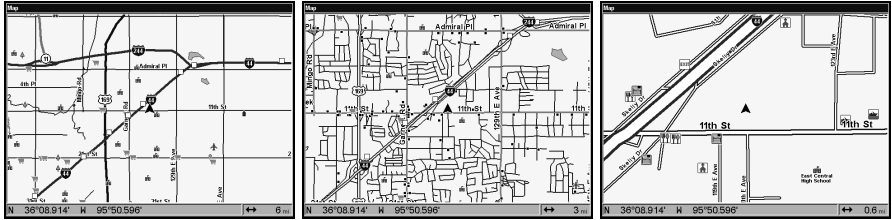

Map Pages with high-detail MapCreate map of an urban area loaded on the MMC. At left, arterial streets appear at the 6 mile zoom range, with a few Point of Interest icons visible. Center, numerous dots representing Points of Interest become visible at the 3 mile range, along with minor streets. Right, at the 0.6 mile zoom, you can see an interstate highway with an exit, major and minor streets as well as Point of Interest icons.

Background map vs. MapCreate map content

The background map includes: low-detail maps of the whole world (containing cities, major lakes, major rivers, political boundaries); and medium-detail maps of the United States.

The medium-detail U.S. maps contain: all incorporated cities; shaded metropolitan areas; county boundaries; shaded public lands (such as national forests and parks); some major city streets; Interstate, U.S. and state highways; Interstate highway exits and exit services information; large- and medium-sized lakes and streams; and more than 60,000 navigation aids and 10,000 wrecks and obstructions in U.S. coastal and Great Lakes waters

MapCreate custom maps include massive amounts of information not found in the background map. MapCreate contains: the searchable Points of Interest database, all the minor roads and streets, all the landmark features (such as summits, schools, radio towers, etc.); more rivers, streams, smaller lakes and ponds and their names.

What's more important is the large scale map detail that allows your GPS unit to show a higher level of position accuracy. For example, the background map would show you the general outline and approximate shape of a coastline or water body, but the higher detail in MapCreate shows the shoreline completely and accurately (finer detail). Many smaller islands would not be included in the background map, but are, of course, in MapCreate.

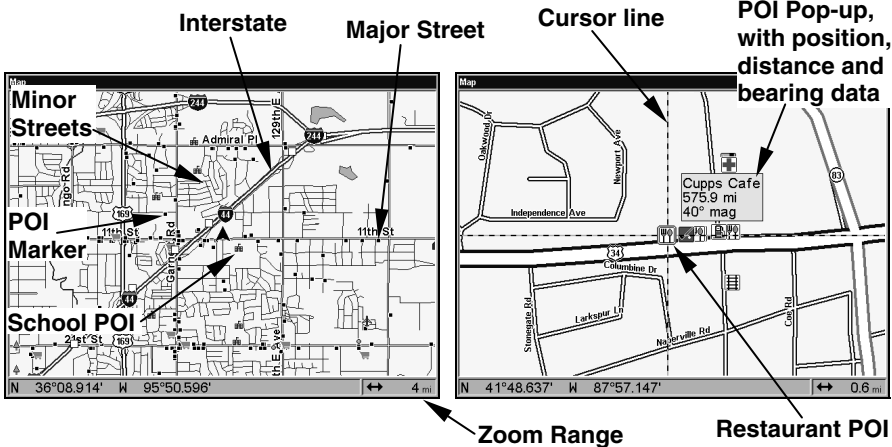

When the map is zoomed out far enough, most POIs appear as square dots. As you zoom in closer, the symbols become readable icons. In the 0.6 mile zoom example at right, the cursor has selected the Cupps Café POI, which triggers a pop-up box with the POI name. This pop-up box works on POIs at any zoom range.

Tip:

In some urban areas, businesses are so close to one another that their POI icons crowd each other on the screen. In the preceding figure, you can see a jumbled pile of POIs along Highway 34. You

can reduce screen clutter and make streets and other map features easier to see by simply turning off the *display* of POIs you're not watching for. (To see how, check the text on Map Detail Category Selection, page 147. It shows how to use the Map Categories Drawn menu to turn individual POI displays off and on.) Even though their display is turned off, you can still search for POIs and their icons will pop-up when your unit finds them for you.

The Map Page has its own menu, which is used for several functions and for setting various options. To access the Map Page Menu, from the Map Page, press **MENU**.

The Pages Menu also offers several map display options under the Map Page category. To access them, press **PAGES** | ← → to **MAP** | ↓ to *Option* | **EXIT**.

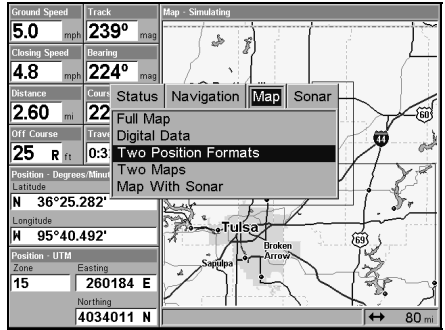
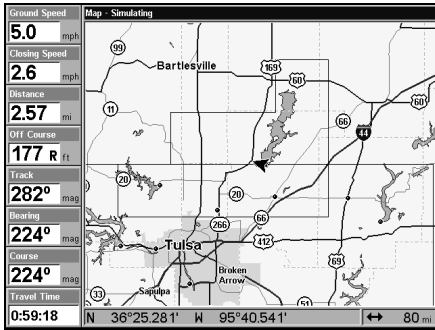

At left, Digital Data map page; at right, Two Position Formats page.

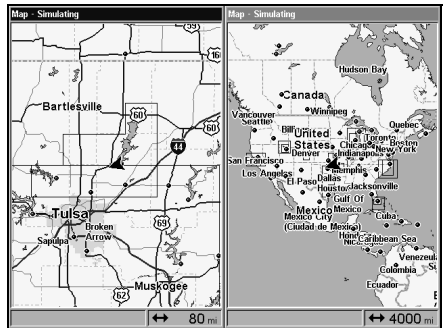
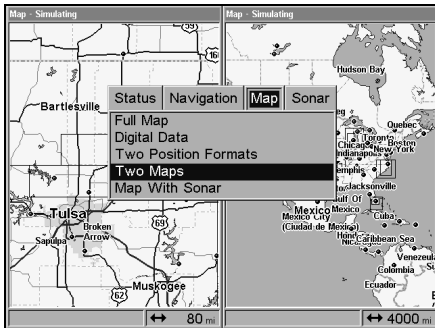

Pages Menu with Two Maps option selected, left.

Map Page with two map windows, at right. The left map is active.

In pages that have two major windows (such as two maps) you can toggle back and forth between the two windows by pressing **PAGES** | **PAGES**. This allows you to change which map the cursor, keyboard and menus

operate on. A dark blue title bar denotes the active window.

Resize Window is another extremely handy feature for pages that have two major windows. You can change the horizontal size of the windows to suit your viewing preference. Here's how:

1. From any two-window display, press **MENU** | ↓ to **RESIZE WINDOW** | **ENT**.
2. Two flashing arrows appear along the centerline dividing the two windows. Press ← or → to adjust the window widths. Press **EXIT** to clear the menu.
3. To change the window size again or revert back to the original display, just follow the steps above. (Most dual-window displays use half the screen for each window by default.) You can also use the Reset Options command to revert to the factory default.

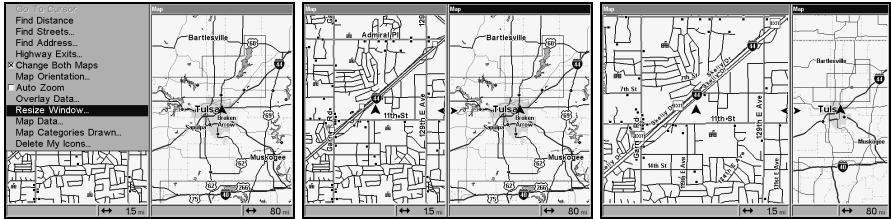

At left, Map Menu with Resize Window command selected. Center, Resize Window command is active. At right, pressing the → key moves the centerline to the right and enlarges the left window.

The following page contains a 12-step quick reference for the most basic GPS operations. If you don't want to carry the manual with you as you practice with the LCX-104C, you might consider photocopying this quick reference page and tucking it into your pocket.

GPS Quick Reference

Start outdoors, with a clear view of the open sky. As you practice, try navigating to a location at least a few blocks away. While you're learning, navigation in too small an area will constantly trigger arrival alarms.

1. Connect the unit to electric power and the antenna module. Make sure the MMC is in. (See complete installation details beginning on page 13.)
2. To turn on the LCX-104C, press and release **PWR** key.
3. Opening screen displays map of North America at the 4,000 mile zoom range. Rotate through the four main Page screens (Map Page, Satellite Status Page, Navigation Page and Sonar Page) by pressing **PAGES** | ← or → to select *Page Name* | **EXIT**. Switch Pages to display Satellite Status Page.
4. Wait while unit locates satellites and calculates current position. Process is visible on Satellite Page. This takes an average of 1 minute or less under clear sky conditions (unobstructed by terrain or structures.) When the unit acquires position, a tone sounds and a position acquired message appears.
5. With position acquired, press **PAGES** key to display Map Page, which shows a bird's eye view of the earth. You can move around the map by:
 - Zoom in** closer to see greater detail: press **ZIN** (zoom in key.)
 - Zoom out** to see more area, less detail: press **ZOUT** (zoom out key.)
 - Scroll** map north, south, east or west using arrow keys ↑ ↓ → ← .To stop scrolling and return to current position on map, press **EXIT** key.
6. Set a waypoint (*Wpt 001*) at your current position so you can navigate back here: press **WPT** | **WPT**. Waypoint symbol and "001" appears.
7. Zoom/scroll map to find a nearby object or location to go to. Use arrow keys to center cursor cross-hair over the map object or location.
8. Navigate to the selected destination: press **MENU** | **ENT** | **EXIT**. Follow the red course line on Map Page or compass bearing arrow on Navigation Page.
9. At destination, Arrival Alarm goes off; to clear it, press **EXIT**. Cancel navigation: press **MENU** | **MENU** | ↓ to **CANCEL NAVIGATION** | **ENT** | ← to **YES** | **ENT**.
10. Return to *Wpt 1* by Navigate To Waypoint or Backtrack Trail. **To Waypoint:** press **WPT** | → to **SAVED** | **ENT** | **ENT** | **ENT**. Use ↑ or ↓ to select *Wpt 001*, press **ENT** | **ENT**; follow navigation displays. **Trail:** press **MENU** | **MENU** | ↓ to **MY TRAILS** | **ENT**. Press ↓ to *Trail 1* | **ENT** | → | ↓ to **NAVIGATE** | **ENT** | ↓ to **NAVIGATE** | → to **REVERSE** | **ENT** | ← to **NAVIGATE** | **ENT**. (If arrival alarm sounds, press **EXIT**.) Follow navigation displays.
11. Back home, Arrival Alarm goes off; press **EXIT**. Cancel navigation: press **MENU** | **MENU** | ↓ to **CANCEL NAVIGATION** | **ENT** | ← to **YES** | **ENT**.
12. To turn off the unit, press and hold **PWR** key for three seconds.

Find Your Current Position

Finding your current position is as simple as turning the unit on. Under clear sky conditions, the unit automatically searches for satellites and calculates its position in approximately one minute or less.

NOTE:

"Clear sky" means open sky, unobstructed by terrain, dense foliage or structures. Clouds do not restrict GPS signal reception.

If for some reason satellite acquisition takes longer, you may be inside a structure or vehicle or in terrain that is blocking signal reception. To correct this, be sure you are positioned so that the unit's antenna module has as clear a view of the sky as possible, then turn the unit off and back on again.

Moving Around the Map: Zoom & Cursor Arrow Keys

The map is presented from a bird's eye view perspective. The current zoom range shows in the lower right corner of the screen.

1. Press the **ZIN** key (zoom in) to move in closer and see greater detail in a smaller geographic area.
2. Press the **ZOUT** key (zoom out) to move farther away and see less map detail, but a larger geographic area.

When you are traveling, the map will automatically move as you move. This keeps your current location roughly centered on the screen.

You can manually pan or scroll the map northward, southward, eastward or westward by using the arrow keys, which launch the cross-hair map cursor. This allows you to look at map places other than your current position. To clear the cursor, press **EXIT**, which jumps the map back to the current position or the last known position.

Tip:

Use the cursor to determine the distance from your current position (or last known position, when working indoors) to any map object. Simply use the arrow keys to position the cursor over the object or landmark. The distance, measured in a straight line, appears in the pop-up box. Press **EXIT** to clear the cursor.

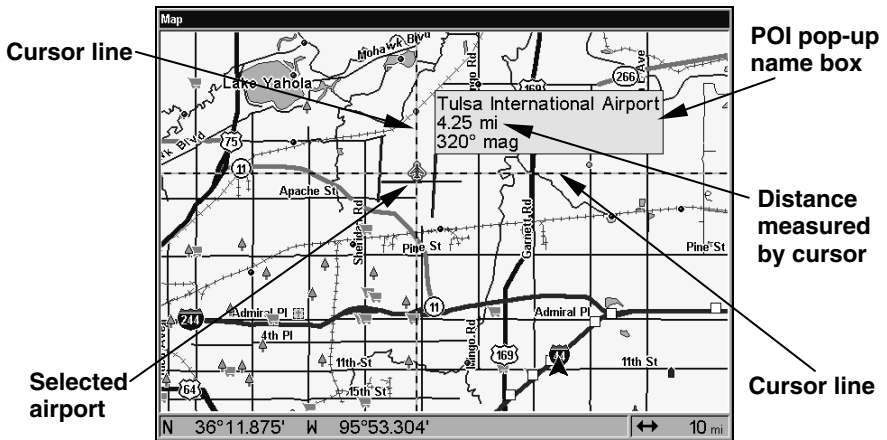

The selected airport to the northwest is 4.25 miles away.

Selecting Any Map Item With the Cursor

1. Use the zoom keys and the arrow keys to move around the map and find the item you wish to select.
2. Use the arrow keys and center the cursor cross-hair on the desired object. On most items, a pop-up box will give the name of the selected item.

Searching

Now that you've seen how the unit can find where *you* are, let's search for something somewhere else. Searching is one of the most powerful features in the Lowrance GPS product line.

In this example, we'll look for the *nearest* fast-food restaurant. For more information on different types of searches, refer to *Sec. 9, Searching*.

NOTE:

This example requires the Point of Interest (POI) database included with a high detail MapCreate 6 custom map.

After the unit has acquired a position:

1. Press **WPT** | ↓ to **POI-RESTAURANTS**.
2. You could search the entire restaurant category, but in this example we will narrow our search. Press → to **SUBCATEGORY** column | ↓ to **FAST FOOD CHAINS** | **ENT** | ↓ to **NEAREST** | **ENT**.
3. The unit says it is calculating, then a list of restaurants appears, with the closest at the top of the list, and the farthest at the bottom of the list. The nearest is highlighted.

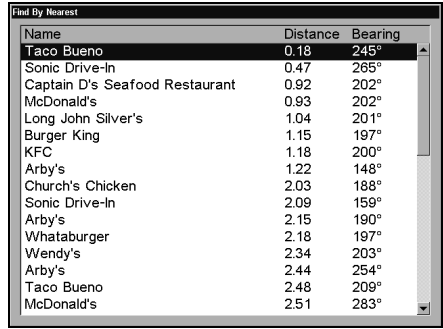

Category Selection menu, left, and list of the nearest restaurants, right.

4. If you wish, you could scroll \uparrow or \downarrow here to select another restaurant, but for now we will just accept the nearest one. Press **ENT**.

5. The POI information screen appears. (This is how you can use the LCX-104C as a business phone directory!) If you wanted to navigate there, you could press **ENT**, since the **Go To** command is highlighted. But we just want to see it on the map, so press \downarrow to **FIND ON MAP****ENT**.

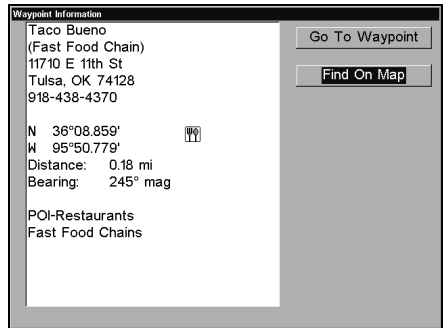
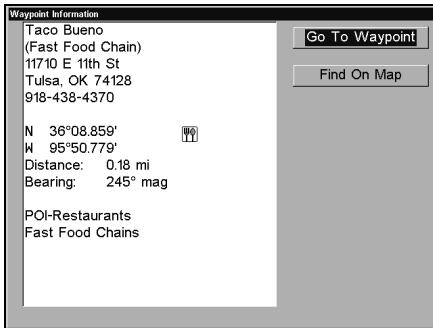

POI information screen on fast food restaurant nearest this position. Screen shows name, street address, phone number, latitude/longitude, distance to restaurant and its compass bearing. Figure at left shows Go To command; right figure shows Find On Map command.

6. The LCX-104C's map appears, with the cross-hair cursor highlighting the restaurant's POI symbol. A pop-up name box identifies the POI, as well as its distance and bearing. A data box at the bottom of the screen continues to display the location's latitude and longitude.

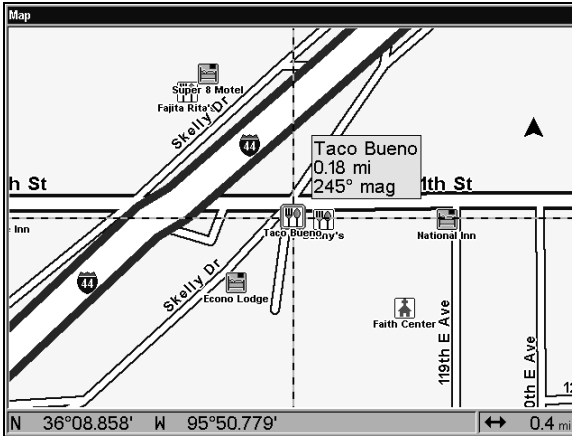

Map screen showing Find Waypoint, the result of a restaurant search.

7. To clear the search and return to the last page displayed, press **EXIT | EXIT | EXIT | EXIT**. (Before you completely exited out of the Search menus, you could have gone looking for another place.)

NOTE:

Search works from mapping and POI data loaded in the LCX-104C. If you do not have a high-detailed custom map (containing POI data) for the area you are searching loaded on the MMC, you may not find anything.

Set a Waypoint

A waypoint is simply an electronic "address," based on the latitude and longitude of a position on the earth. A waypoint represents a location, spot, or destination that can be stored in memory, then be recalled and used later on for navigation purposes.

You can create a waypoint at the cursor position on the map, or at your current position while you are navigating. You can create a waypoint at any location by manually entering the position's latitude and longitude. You can copy waypoints from your unit to your personal computer with MapCreate software. When you want to repeat a trip, these archived waypoints can be reloaded into your GPS unit.

To create and save a Waypoint:

These first two techniques use the Quick Save method, the fastest and easiest way to create a waypoint.

Create Waypoint at Current Position

While you are traveling, press **WPT | WPT**. The waypoint is saved and automatically given a name with a sequential number, such as "waypoint 003." The waypoint symbol and number appear on the map.

Step 1.

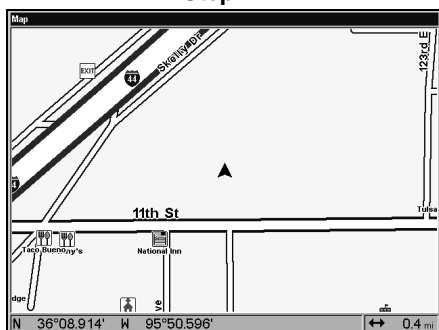

Step 2.

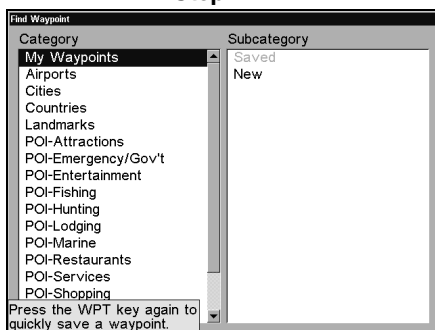

Step 3.

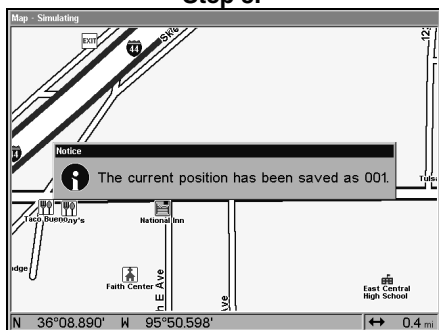

Step 4.

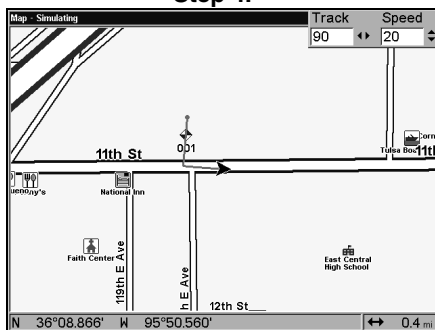

Sequence for setting a waypoint. Step 1: while traveling, *quickly* press **WPT** *twice* to call up Find Waypoint screen (seen in Step 2) and set a point. Step 3: a message says the waypoint has been saved. Step 4: vehicle continues on its way; number waypoint symbol is visible on map.

NOTE:

The Quick Save method uses the default waypoint symbol until you edit an existing waypoint and change its symbol. (Edit Waypoint Symbol is described in Sec. 7.) After you have changed a waypoint symbol, the unit will remember the one you chose and use it the *next* time you "quick save" a waypoint. To revert back to the *default* symbol, edit a waypoint and choose it, or use the Reset Options command (described in Sec. 8).

Create Waypoint on Map

1. Use the arrow keys to move the cursor to the place where you want to make a waypoint.
2. Press **WPT|WPT**. The waypoint is saved and automatically given a name with a sequential number, such as "waypoint 001." The waypoint symbol and number appear on the map.

Create Waypoint by Entering a Position

1. Press **WPT** | → to **SUBCATEGORY** column | ↓ to **NEW** | **ENT**.
2. Press ↓ to **ENTERED POSITION** | **ENT** | → to **CREATE** | **ENT**.
3. Press → to **LATITUDE** | **ENT**. Enter the latitude by pressing ↑ or ↓ to change the first character, then press → to the next character and repeat until the latitude is correct. Press **ENT**.
4. Press ↓ to **LONGITUDE** | **ENT**. Enter the longitude by pressing ↑ or ↓ to change the first character, then press → to the next character and repeat until the longitude is correct. Press **ENT**, then **EXIT** | **EXIT** to return to the previous page display. The waypoint is saved and automatically given a name with a sequential number, such as "waypoint 001." The waypoint symbol and number appear on the map and in the waypoint list.

Navigate To a Waypoint

You can select any waypoint visible on the Map Page with the cursor, then use the Navigate to Cursor command (we'll describe how later in this section.) However, you can avoid scrolling the map to pick your waypoint if you use the Find Waypoint commands:

1. Press **WPT** | → to **SAVED** | **ENT**. To look up the nearest waypoint, press ↓ to **NEAREST** | **ENT**; or, to look by name (and scroll through the entire waypoint list), press **ENT**. For this example, look by name.
2. If your waypoint list is a long one, you can spell out the waypoint name in the **FIND BY NAME** box to search for it. (Press ↑ or ↓ to change the first character, then press → to move the cursor to the next character and repeat until the name is correct, then press **ENT** to jump to the list below.)
3. If the list is short, you can jump directly to the **FIND IN LIST** box by pressing **ENT**. Use ↑ or ↓ to select the waypoint name, press **ENT** and the waypoint information screen appears with the **Go To** command selected.
4. To begin navigating to the waypoint, press **ENT**.

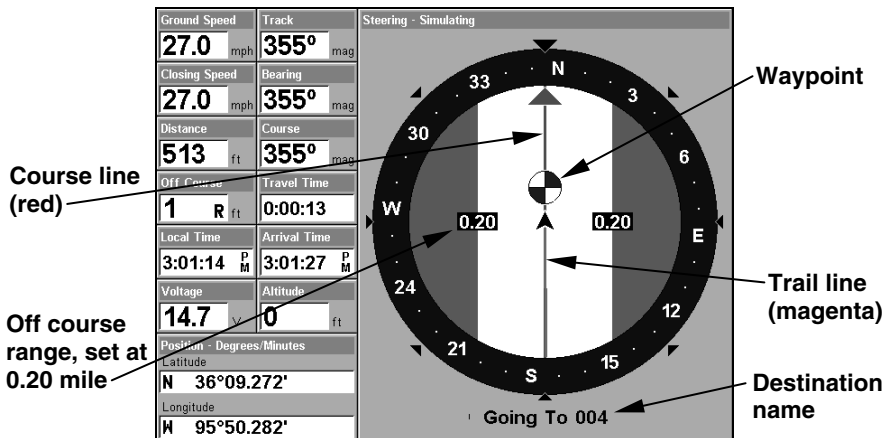

Navigation Page, navigating toward waypoint 004 and leaving a trail.

Set Man Overboard (MOB) Waypoint

One of boating's most terrifying events is having a friend or family member fall overboard. This situation can be deadly on any body of water — fresh or salt. It's particularly dangerous at night or if you're out of sight of land. Of course, the first thing to do is remain calm and then use all standard safety procedures to rescue the person.

This unit has a man overboard feature that shows navigation data to the location where the feature was activated. To activate it, press the **ZOUT** and **ZIN** keys at the same time. Your position at the time these keys are pressed is used as the man overboard position.

Caution:

Saving a new "Man Overboard" waypoint will overwrite and erase the previous "Man Overboard" waypoint.

Navigate Back to MOB Waypoint

Find your way back to the accident position with the Navigation Page or Map Page. When MOB is activated, the Navigation Page automatically shows the compass rose with its bearing arrow pointing toward the man overboard position, and the destination name says "Going To Man Overboard." The Map Page displays a Man Overboard waypoint, represented by a human figure, and the steering arrow points where to steer to reach that position.

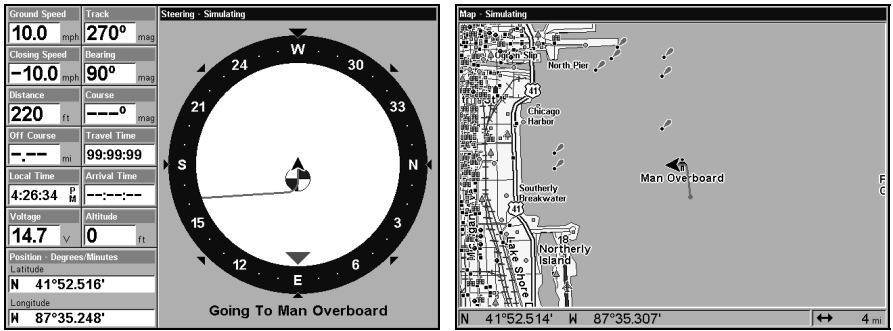

Navigating to Man Overboard: Navigation Page, left, and Map Page, right. The victim is astern of the vessel; the GPS shows which direction to steer to for the rescue.

The man overboard position is also stored in the waypoint list for future reference. It can be edited the same as any other waypoint.

To cancel navigation to MOB, press **MENU | MENU | ↓** to **CANCEL NAVIGATION | ENT | ←** to **YES | ENT**. The unit stops showing navigation information.

Navigate to Cursor Position on Map

The **GO TO CURSOR** command navigates to the current cursor position on the map. It's a quick and handy way to navigate to anything you can see on the map display.

1. Use the cursor (controlled by the arrow keys) with the zoom in and zoom out keys to maneuver around the map until you find a location you want to go to.
2. Center the cursor over the location to select it. See the example in the following figure. (Many map items such as waypoints, Points of Interest, towns, etc. can be "selected," and appear "highlighted" with a pop-up box. Other features, such as a river or a street intersection will not appear "highlighted," but the cursor will take you to those locations just the same.)

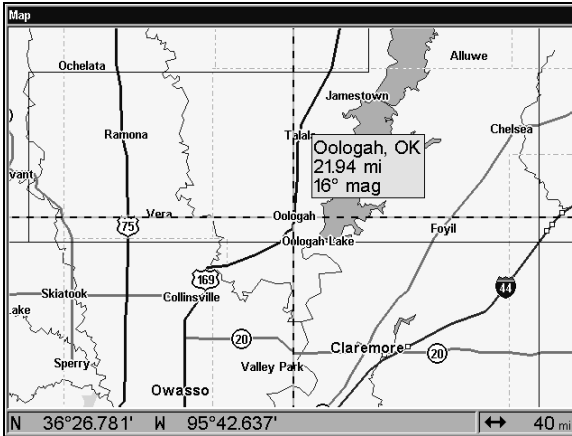

Navigate to cursor. In this example, the cursor has selected the town of Oologah, Oklahoma.

3. Press **MENU|ENT** and the LCX-104C will begin navigating to the cursor location.

The Map Page will display a red line from your current position to the cursor position. The Navigation Page displays a compass rose showing navigation information to your destination. See the following examples.



The 30-mile zoom figure at left clearly shows the red course line connecting your current position to your destination. The 30-mile zoom, center, shows both current position and direction to destination on screen. The Navigation Page, right, will also show navigation information.

To stop navigating to the cursor, use the Cancel Navigation command: press **MENU|MENU|↓** to **CANCEL NAVIGATION|ENT|←** to **YES|ENT**. The LCX-104C stops showing navigation information.

Navigate to a Point of Interest

For POIs that are in view on the map, you can easily use the Navigate to Cursor command above; just use the cursor to select the POI.

The other method involves searching for POIs with the Find Waypoint command, launched with the **WPT** key. (See the searching example earlier in this section, or turn to Sec. 9, *Searching*, for detailed instructions on POI searches.)

After you have looked up an item with the Find Waypoint command, use the → to make sure the **Go To** command is highlighted at the top of the screen, then press **ENT**. The LCX-104C begins showing navigation information to the item.

To cancel navigation, press **MENU | MENU | ↓** to **CANCEL NAVIGATION | ENT | ←** to **Yes | ENT**. The LCX-104C stops showing navigation information.

Creating and Saving a Trail

A trail, or plot trail, is a string of position points plotted by the LCX-104C as you travel. It's a travel history, a record of the path you have taken. Trails are useful for repeating a journey along the same track. They are particularly handy when you are trying to retrace your trip and go back the way you came. On the screen, trails are represented by a magenta line extending from the back of the current position arrow.

The LCX-104C is set at the factory to automatically create and record a trail while the unit is turned on. The unit will continue recording the trail until the length reaches the maximum trail point setting (default is 2,000, but the unit can record trails 9,999 points long). When the point limit is reached, the LCX-104C begins recording the trail over itself.

By default, the trail flashes once a second, making it easier to see against the background map. With the default auto setting, the LCX-104C creates a trail by placing a dot (trail point) on the screen every time you change directions. (The methods used for creating a trail and the trail update rate can both be adjusted or even turned off. See Sec. 8 for *Trail Options*.)

To preserve a trail from point A to point B, you must "turn off" the trail by making it *inactive* before heading to point C or even back to point A. When the current trail is set inactive, the LCX-104C *automatically* creates and begins recording a new trail.

To Save a Trail

1. Press **MENU | MENU | ↓** to **MY TRAILS | ENT**.

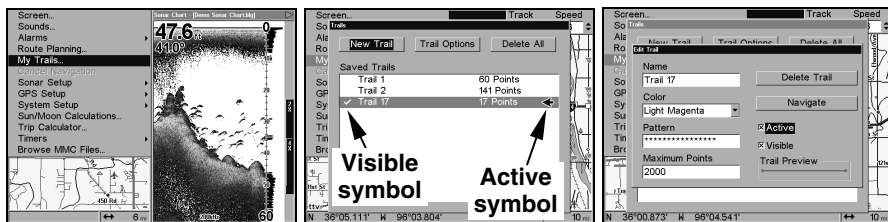

Sequence for saving a trail and beginning a new one. At left, My Trails command. Center, the Trails Menu. The arrow to the right of Trail 17 indicates the trail is "active," and the check to the left indicates the trail is visible on the map display. The right figure shows the Edit Trail menu, with the Active command selected.

2. Press ↓ to the *Active Trail Name* | **ENT**.
3. Press ↓ to **ACTIVE** | **ENT**. This unchecks the Active option.
4. To return to the previous page, press **EXIT** | **EXIT** | **EXIT** | **EXIT**. As you left the Edit Trail menu, you will notice that a new trail was started with a new sequential number. In the example figure below, the new trail is number 15, showing zero points. Note that Trail 14 is inactive, but it is still visible on the map.

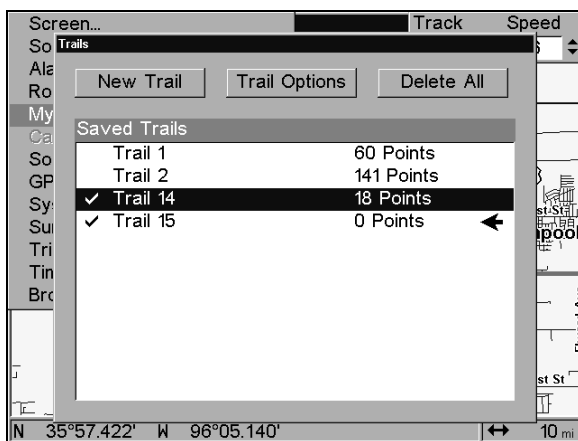

New trail, named "Trail 15," is created when Trail 14 is made inactive. Any new travel will be recorded in this trail, which is active and visible. Trails do not need to be visible in order to be active.

You can save and recall up to 10 different plot trails, which can also be copied to your MMC for archiving or for transfer to your MapCreate software.

Tip:

Another quick way to stop recording one trail and begin a new one is to use the New Trail command: Press **MENU | MENU | ↓** to **MY TRAILS | ENT | ENT**.

Caution:

You also have the option of completely turning off trail recording, under the trail Options command. However, if the Update Active Trail option is left turned off, it will cancel the automatic trail creation feature.

Displaying a Saved Trail

The active trail is automatically displayed on the map (the "Visible" option) with the factory default settings. You can selectively turn trail display off and on for any saved or active trail. In the Saved Trails List, visible trails have a check mark in front of the trail name.

To turn off trail display:

1. Press **MENU | MENU | ↓** to **MY TRAILS | ENT**.
2. Press **↓ | ↓** to enter the Saved Trail list, then use **↑** or **↓** to select the desired *Trail Name* | **ENT**.
3. Press **↓** to **ACTIVE | →** to **VISIBLE | ENT**. To return to the previous page, press **EXIT | EXIT | EXIT | EXIT**.

To turn on trail display:

1. Press **MENU | MENU | ↓** to **MY TRAILS | ENT**.
2. Press **↓ | ↓** to enter the Saved Trail list, then use **↑** or **↓** to select the desired *Trail Name* | **ENT**.
3. Press **↓** to **ACTIVE | →** to **VISIBLE | ENT**. To return to the previous page, press **EXIT | EXIT | EXIT | EXIT**.

Navigating Trails

There are three methods for following a trail: visual trailing, navigating a trail (forward) and backtracking a trail (backward). Try each method to see which you prefer.

Visual trailing is the simplest method. It uses only the Map Page and requires no menu commands at all. The technique works the same if you are running a trail forward (from start to end) or backward (from end to start.) However, visual trailing provides no navigation information during the trip, such as the time to your destination.

The other two methods provide a full range of navigation data and work with both the Map Page and Navigation Page. The only difference between them is "navigating a trail" follows a trail forward (from start to end) while "backtracking" follows a trail in reverse (from end to start.)

When hiking at walking speed with a hand-held GPS, we often just use visual back trailing because it is a bit better at following each little turn on a foot path. At faster speeds, such as the highway or on the water, the Navigate Trail and Backtrack Trail commands are handy.

Visual Trailing

1. On the Map Page, zoom (**ZIN** or **ZOUT**) so your flashing trail is visible.
2. Begin moving and watch the Map Page. Simply walk or steer so that your current position arrow traces along the trail you have just made.

Tip:

Generally, when using this method, the smaller the zoom range, the more accurately you will be able to steer along the trail.

Navigate a Trail (forward)

The following figures illustrate the menu sequence for navigating a trail.

1. Press **MENU | MENU | ↓** to **MY TRAILS | ENT**.
2. Press **↓ | ↓** to enter the Saved Trail list, then use **↑** or **↓** to select the desired *Trail Name* | **ENT**.
3. Press **→** to **DELETE TRAIL | ↓** to **NAVIGATE | ENT**.
4. Press **↓** to **NAVIGATE | ENT**. The unit begins showing navigation information along the trail.

NOTE:

If you are already located at or near the beginning of your trail, the arrival alarm will go off as soon as you hit Enter. Just press **EXIT** to clear the alarm and proceed.

5. Now, begin moving and follow your LCX-104C.
6. When you reach your destination, be sure to cancel your navigation: press **MENU | MENU | ↓** to **CANCEL NAVIGATION | ENT**. The LCX-104C asks if you're sure; press **← | ENT**.

Figure 1.

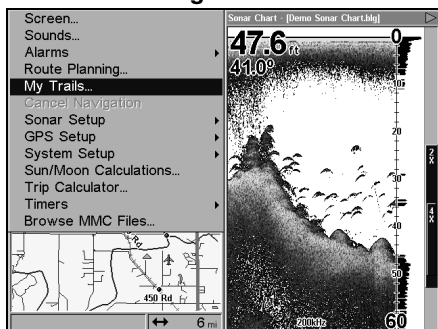

Figure 2.

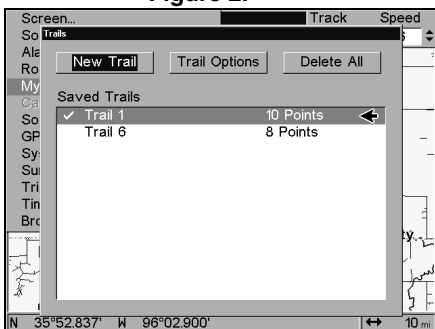

Figure 3.

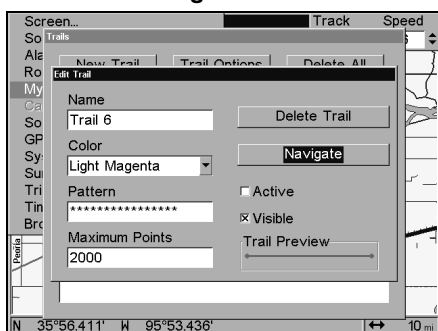
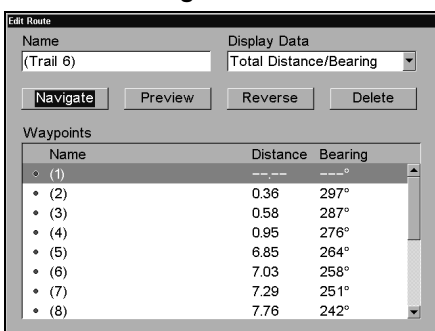

Figure 4.



Navigate a trail menu sequence: Fig. 1, My Trails command. Fig. 2, Trails Menu. Fig. 3, Edit Trail Menu. Fig. 4, Edit Route Menu with Navigate command highlighted for Trail 6. A trail is always converted to a "route" when you navigate the trail.

On the Map Page, the trail you are navigating is represented by a magenta line. The Navigation Page will also show the navigated trail as a magenta line. The bearing arrow on the compass rose points to the next waypoint on the trail.

As you travel, the arrival alarm will go off when you near a trail waypoint, and the bearing arrow on the compass rose will swing around and point to the next trail waypoint. Press **EXIT** to clear the alarm.

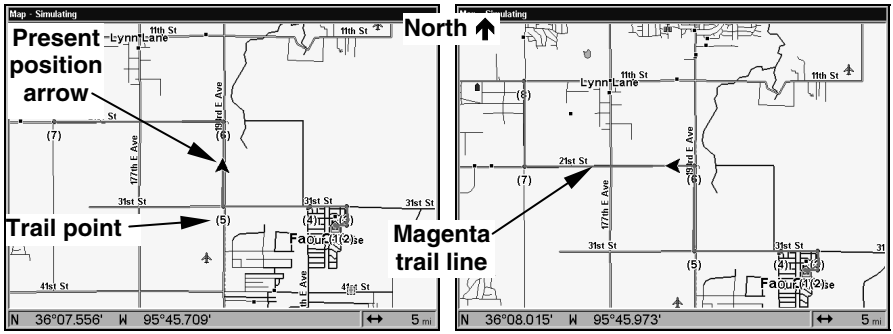

Navigate trail, map views: at left driver is northbound heading straight toward trail point 6. At right, northbound driver has reached point 6 and has turned west to follow trail.

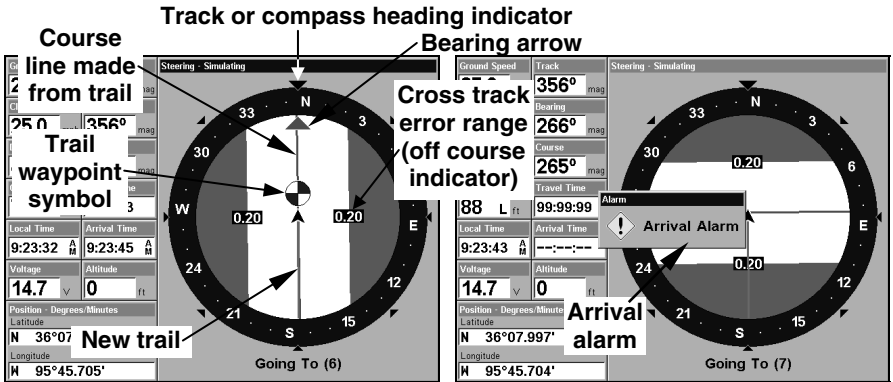

Navigate trail, navigation page (compass rose) views: at left, driver is northbound heading straight toward trail point 6; bearing arrow shows the trail point is due north (straight ahead.) At right, driver has reached trail point 6 and must turn west to follow the trail. Arrival alarm goes off and bearing arrow swings around to say turn left (west), toward the next waypoint, trail point 7. The LCX-104C now shows navigation information to point 7, which is 1.99 miles away.

Navigate a Back Trail (backtrack, or reverse)

1. Press **MENU | MENU | ↓** to **MY TRAILS | ENT.**
2. Press **↓|↓** to enter the Saved Trail list, then use **↑** or **↓** to select the desired *Trail Name* | **ENT.**
3. Press **→** to **DELETE TRAIL | ↓** to **NAVIGATE | ENT.**
4. Press **↓** to **NAVIGATE | →** to **REVERSE | ENT | ←** to **NAVIGATE | ENT.** The unit begins showing navigation information along the trail, in reverse.

NOTE:

If you are already located at or near the end of your trail, the arrival alarm will go off as soon as you hit Enter. Just press **EXIT** to clear the alarm and proceed.

5. Now, begin moving and follow your LCX-104C.

6. When you reach your destination, be sure to cancel your navigation: press **MENU | MENU | ↓** to **CANCEL NAVIGATION | ENT**. The LCX-104C asks if you're sure; press **← | ENT**.

Transfer Custom Maps and GPS Data Files

Custom Maps:

Custom maps work only from the MMC card or SDC card. When a card containing a Custom Map File is loaded into the unit, it automatically loads the map into memory when the unit is turned on.

Instructions for copying Custom Map Files to an MMC are contained in the instruction manual for your MMC card reader and MapCreate 6 software. For instructions on inserting an MMC into the LCX-104C, see *Sec. 2, Installation/Accessories*.

NOTE:

To load a Navionics® chart, see Sec. 8 for the entry *Navionics Charts*.

GPS Data files:

GPS Data Files contain waypoints, routes, trails and event marker icons. Instructions for copying GPS Data Files between your computer and an MMC are contained in the instruction manual for your MMC card reader and MapCreate 6 software.

GPS data automatically recorded in the unit's internal memory must be saved to the MMC (as a GPS Data File) in order to store it on your personal computer. GPS Data Files stored on an MMC must be copied from the card to the LCX-104C's internal memory before the unit can read them. Here's how:

1. Insert the MMC into your unit. Press **MENU | MENU | ↓** to **SYSTEM SETUP | ENT | ↓** to **TRANSFER MY DATA | ENT** and the screen below appears.

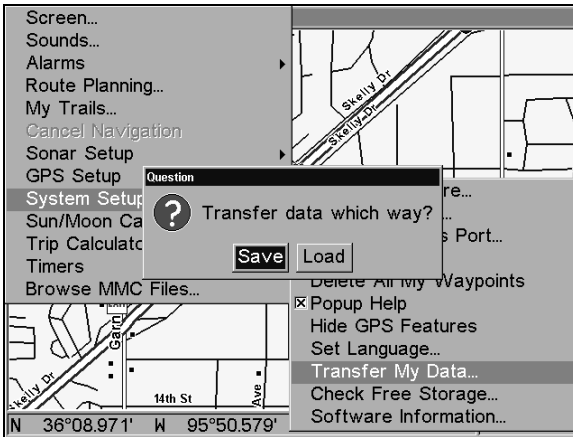

The Transfer My Data submenu asks if you want to save data to the MMC or load data from the MMC into the LCX-104C's memory.

2. The Transfer My Data menu includes a message which tells you if an MMC is present or not. If no MMC is present, you must first insert a card into the LCX-104C in order to activate the Load or Save commands.

To transfer data *from the unit to the MMC*: press **ENT** (for **SAVE**.)

To transfer data *from the MMC to the unit*: press **→** to **LOAD** | **ENT**.

3. **Saving to MMC**: To accept the default name "Data" for the GPS Data File, press **↓** to **SAVE DATA** | **ENT**. If you wish to rename the file (as shown in the following figures), press **ENT** to activate the selection box. Press **↑** or **↓** to change the first character, then press **→** to the next character and repeat until the name is correct. Then, press **ENT** | **↓** to **SAVE DATA** | **ENT**.

The unit will display first a progress then a completion message when the data transfer is finished. To return to the Page view, repeatedly press **EXIT**.

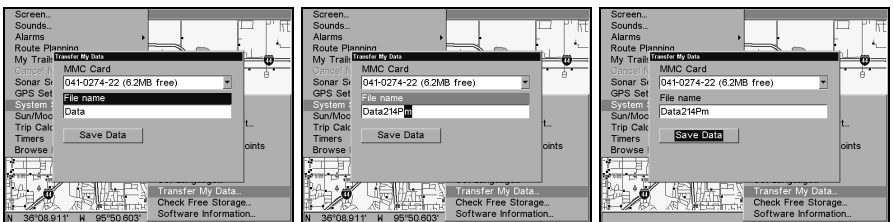

From left to right, these figures show the menu sequence for naming and saving a GPS Data File from the LCX-104C's memory to an MMC.

4. **Loading to unit memory:** There may be more than one GPS Data File (*.USR) on the card. To select a file, press **ENT** to activate the selection box, use **↓** or **↑** to highlight the file, then press **ENT** to accept the selection. Next, press **↓** to **LOAD | ENT**. The unit will display a completion message when the data transfer is finished. To return to the Page view, press **EXIT | EXIT | EXIT | EXIT**.

Figure 1.

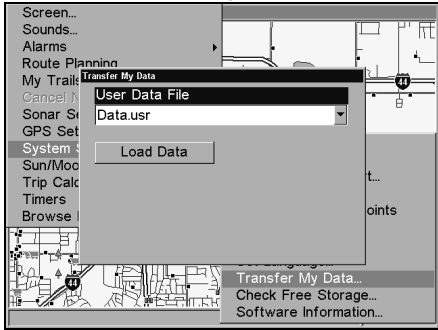

Figure 2.

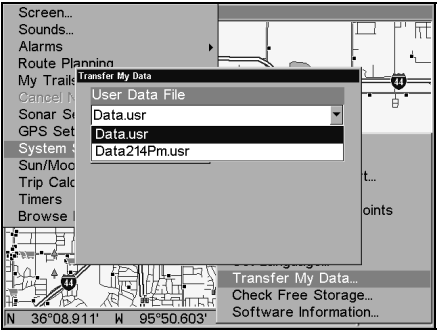

Figure 3.

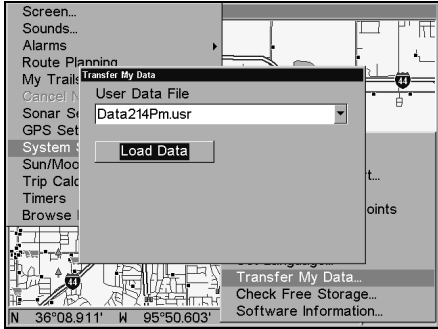
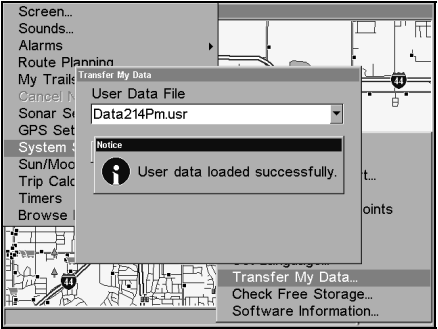

Figure 4.



These figures show the menu sequence for loading a GPS Data File from an MMC into the LCX-104C's memory.

Cancel Navigation

You can turn off any of the navigation commands after you reach your destination or at any other time by using the Cancel Navigation command. Press **MENU | MENU | ↓** to **CANCEL NAVIGATION | ENT** | **←** to **YES | ENT**.

Notes

Section 7: Advanced GPS Operations

Find Distance From Current Position To Another Location

1. While on the Map Page press: **MENU** | ↓ to **FIND DISTANCE** | **ENT**.
2. Center your cursor over the position you want to find the distance to. A rubber band line appears, connecting your current position to the cursor's location. The distance along that line will appear in a pop-up box. The box also shows the bearing to the point you're measuring to.
3. Press **EXIT** to return to regular operation.

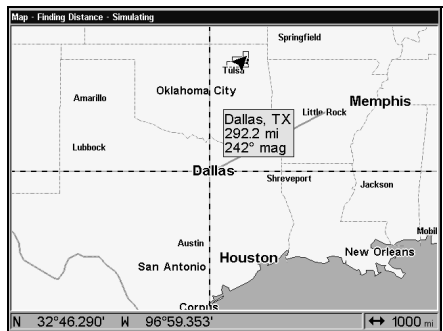
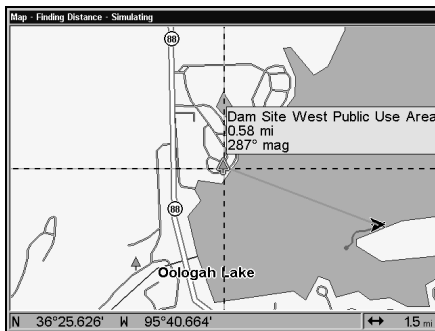

At left, the distance from the boat's current position to the boat ramp is 0.58 miles. At right, the distance from Dallas to Little Rock is 292.2 miles.

Find Distance From Point to Point

You can also measure distance between two other points on the map.

1. While on the Map Page press: **MENU** | ↓ to **FIND DISTANCE** | **ENT**.
2. Center your cursor over the first position. (A rubber band line appears, connecting your *current* position to the cursor's location.) Press **ENT** to set the first point, and the rubber band line disappears.
3. Move the cursor to the second position. The rubber band line reappears, connecting the first point you set to the cursor. The distance along that line will appear in a pop-up box.
4. Press **EXIT** to clear the command and return to the page screen.

Icons

Icons are graphic symbols used to mark some location, personal point of interest or event. They can be placed on the map screen, saved and re-

called later for navigation purposes. These are sometimes referred to as event marker icons. The LCX-104C has 42 different symbols you can pick from when creating an icon.

Icons are similar to waypoints, but they do not store as much information (like names) as waypoints do. You can't use a menu to navigate to icons as you can with waypoints. (But, you *can* use the map cursor and navigate to any icon on the map.)

You can create an icon at the cursor position on the map, or at your current position while you are navigating.

Create Icon on Map

1. Use the arrow keys to move the cursor to the place where you want to make an icon.
2. Press **ENT** and the screen shows a "Select Icon Symbol" menu.
3. Press **←** or **↑** or **→** or **↓** to select your icon symbol, then press **ENT**. The icon appears on the map.

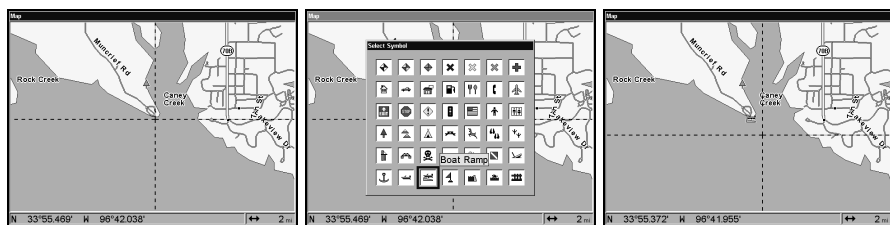

Cursor selects icon location, left; Select Icon Symbol menu, center; Boat Ramp icon on map, right. (Cursor has been moved for clarity.)

Create Icon at Current Position

1. While you are traveling, press **ENT** and the screen shows a "Select Icon Symbol" menu.
2. Press **←** or **↑** or **→** or **↓** to select your icon symbol, then press **ENT**. The icon appears on the map.

Delete an Icon

You can delete all the icons at one time, you can delete all icons represented by a particular symbol, or you can use the cursor to delete a selected icon from the map.

1. Press **MENU** | **↓** to **DELETE MY ICONS** | **ENT**.
2. Press **↓** to **DELETE ALL ICONS**, **DELETE BY SYMBOL**, or **DELETE FROM MAP** and press **ENT**.

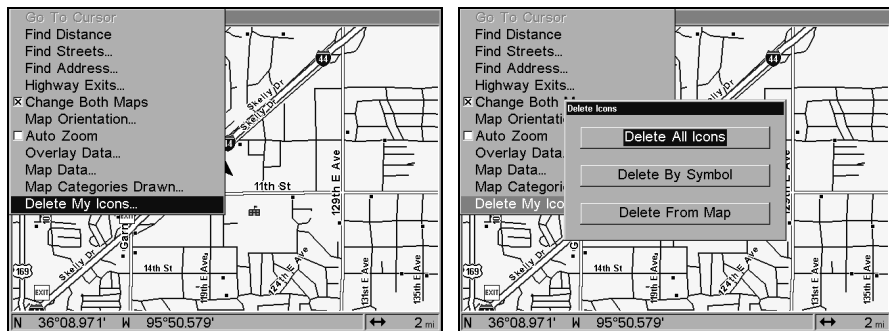

Delete icons menu.

The Delete All Icons command will ask if you are sure. Press ← to **YES** | **ENT**. All icons will be deleted from the map.

The Delete by Symbol command will launch the Select Symbol menu. Press ← or ↑ or → or ↓ to select the icon symbol to delete, then press **ENT**. A message appears saying all icons with the selected symbol have been deleted.

The Delete From Map command will prompt you to move the cursor over an icon to select it. After selecting the icon, press **ENT** and it disappears from the map.

Navigate to an Icon

Use the Navigate to Cursor command, and use the cursor to select the desired icon on the map.

1. Use arrow keys to center cursor cross-hair over the icon.
2. To navigate to the selected icon location: press **MENU** | **ENT** | **EXIT**. Follow course line on the Map Page or the compass bearing arrow on the Navigation Page.

Routes

A route is a series of waypoints, linked together in an ordered sequence, that's used to mark a course of travel. You can visualize a route as a string of beads: The beads represent waypoints and the string represents the course of travel connecting waypoint to waypoint.

The course from one waypoint to the next is a leg; routes are composed of one or more legs. The legs of all GPS routes are based on straight lines between waypoints.

A route provides the automatic capability to navigate through several waypoints without having to reprogram the unit after arriving at each

waypoint. Once programmed into the GPS unit, a route provides the option of navigating forward through the route waypoints or in reverse order (you can even begin navigating in the middle of a route!)

Create and Save a Route

You have the option of creating and editing a route in the unit, or you can make a route on your computer with our MapCreate 6 software.

PC-created Routes

MapCreate is the easiest method for preparing a route, simply because your PC's larger screen, keyboard and mouse are easier to manipulate than the gimbal-mounted LCX-104C.

To load a MapCreate route into the LCX-104C, follow instructions in MapCreate's manual for creating a route and saving it as part of a GPS Data File (file format *.usr). Copy the GPS Data File to an MMC and insert the MMC in the LCX-104C. (See Sec. 2 for instructions on installing MMCs. To load the GPS Data File into the LCX-104C memory, see the entry on *Transfer Custom Maps & GPS Data Files* in Sec. 6, *Basic GPS Operations*.)

Routes Created in the Unit

You can create a route by selecting existing waypoints from the waypoint list or you can set a series of route waypoints on the map with cursor arrows and the Enter key. In this example, we'll create a route from the map.

1. From the **NAVIGATION PAGE**, press **MENU|ENT** or from the **MAP PAGE**, press **MENU|MENU|↓** to **ROUTE PLANNING|ENT**.

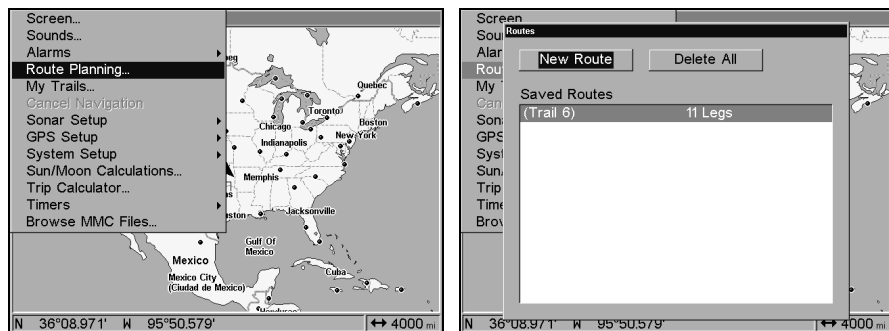

Route Planning command on Main Menu, left,
will open the Route List screen, right.

2. Press **↓|↓|↑** or **↓** to route name|**ENT**|**↓** to **(ROUTE END)|ENT**|**↓** to **ADD FROM MAP|ENT**. The Map Page appears with the cursor showing.

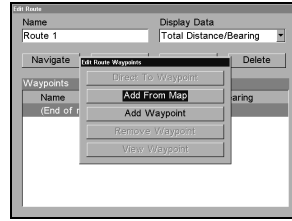
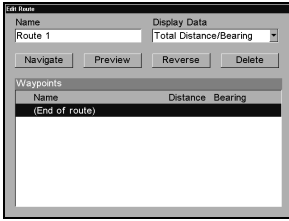

Edit Route menu, left. Edit Route Waypoints menu, right, with Add From Map command selected.

3. Use the Zoom keys and arrow keys to move the map and cursor until the cursor is centered on the spot where you want your route to begin. (If you are starting at your current position or the current cursor position, you are already at the starting spot.)

4. Set the first route waypoint: press **ENT**. In this example, we moved to the intersection of 11th Street and 145th E. Ave. to start our route to a public hunting area next to a river. (Creating this example route is illustrated in the following figures.)

1.

2.

3.

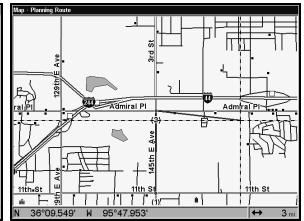
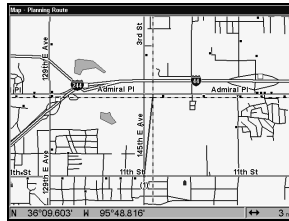
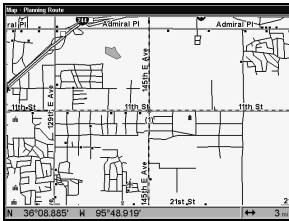

Route creation sequence, from left: Fig. 1. Set route waypoint (1) at 11th St. & 145th Ave. Fig. 2. Move cursor north to set point (2) at 145th & Admiral. Fig. 3. With point (2) set, move cursor east to mark interstate on-ramp with waypoint (3). In figures 2 and 3, notice the rubber band line extending from the previously set waypoint to the cursor. This line will become the course for the route.

This line will become the course for the route.

4.

5.

6.

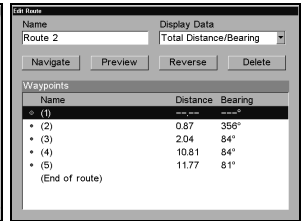
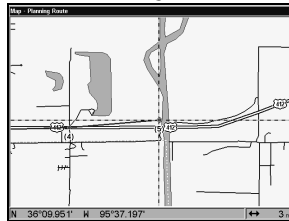
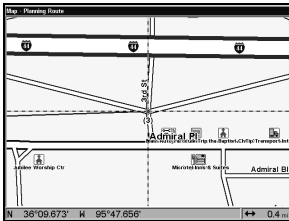

Route creation sequence, continued: Fig. 4. Point (3) set at on-ramp turn. Fig. 5. Waypoint (4) set at highway exit to frontage road leading to river. Waypoint (5) ends the route at a tree stand in the hunting area. Fig. 6. Press **EXIT** to save the route and you return to this screen.

5. Move the cursor to the next point in the route, a spot where you need to turn or change direction, and press **ENT** to set the next waypoint.

6. Repeat step five until the route reaches your destination.

7. To save your route, press **EXIT**. The LCX-104C reverts to the Edit Route screen, with the route automatically named "Route 1" and stored in the LCX-104C's internal memory. (In our example, Route 1 already existed, so the unit automatically made "Route 2.")

You can edit the route and run other commands, but if you are finished with the route for now, return to the last page displayed by pressing **EXIT | EXIT | EXIT | EXIT | EXIT**.

Delete a Route

1. From the **NAVIGATION PAGE**, press **MENU | ENT** or from the **MAP PAGE** press **MENU | MENU | ↓** to **ROUTE PLANNING | ENT**.

2. Press **↓** to *route name* | **ENT**.

3. Press **↓** to **NAVIGATE | ENT | →** to **DELETE | ENT | ←** to **Yes | ENT**.

Tip:

You can also delete all routes at once:

1. From the **NAVIGATION PAGE**, press **MENU | ENT** or from the **MAP PAGE** press **MENU | MENU | ↓** to **ROUTE PLANNING | ENT**.

2. Press **→** to **DELETE ALL | ENT | ←** to **Yes | ENT**.

Edit a Route

You can edit the route name if you wish.

1. From the **NAVIGATION PAGE**, press **MENU | ENT** or from the **MAP PAGE** press **MENU | MENU | ↓** to **ROUTE PLANNING | ENT**.

2. Press **↓** to *route name* | **ENT | ENT**.

3. Press **↑** or **↓** to change the first character, then press **→** to move the cursor to the next character and repeat until the name is correct, then press **ENT**. Return to the previous page by pressing **EXIT | EXIT | EXIT | EXIT**.

You can edit the route by adding and removing waypoints.

1. From the **NAVIGATION PAGE**, press **MENU | ENT** or from the **MAP PAGE** press **MENU | MENU | ↓** to **ROUTE PLANNING | ENT**.

2. Press **↓** to *route name* | **ENT | ↓** to **ROUTE WAYPOINTS LIST**. Use **↓** and **↑** to select a waypoint, then press **ENT**.

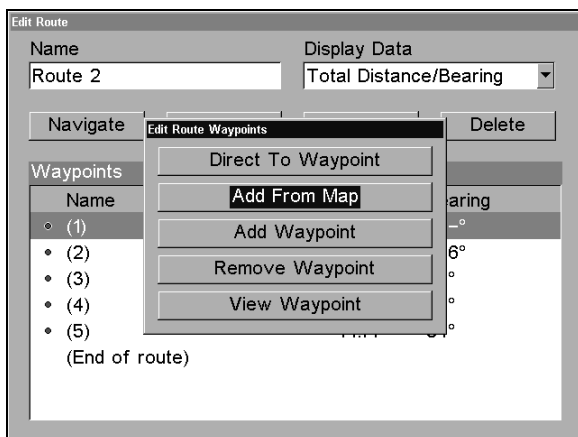

Edit Route Waypoints menu.

3. Use ↓ and ↑ to select a command from the Edit Route Waypoints menu and press **ENT**. Add From Map lets you insert a waypoint in the route by clicking on a map location with the cursor. Add Waypoint calls up the Waypoint List so you can insert a waypoint from the list. Remove Waypoint will delete the waypoint from the route. View Waypoint will show you where the selected waypoint is on the map.

Navigate a Route

1. From the **NAVIGATION PAGE**, press **MENU | ENT** or from the **MAP PAGE**, press **MENU | MENU | ↓** to **ROUTE PLANNING | ENT**.

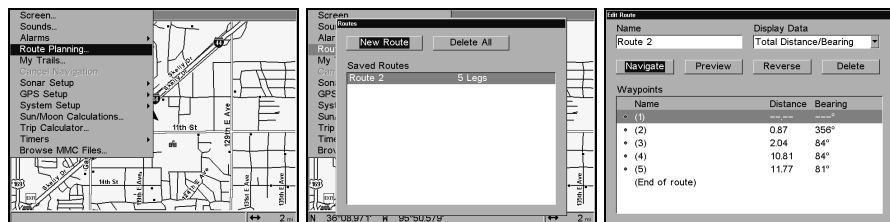

Route Planning command on Main Menu, left; Routes menu, center; Edit Route menu, right. Navigate command is selected.

2. Press ↓ to select *route name* | **ENT** | ↓ to **NAVIGATE** | **ENT** | **ENT**.

3. Upon arrival at your destination, cancel navigation: press **MENU | MENU | ↓** to **CANCEL NAVIGATION** | **ENT** | ← to **YES** | **ENT**.

The following figures show what the Navigation Page and Map Page look like while navigating a route.

Navigate a Route in Reverse

Here's how you run a route backward, from the end waypoint to the beginning waypoint:

1. From the **NAVIGATION PAGE**, press **MENU|ENT** or from the **MAP PAGE**, press **MENU|MENU|↓** to **ROUTE PLANNING|ENT**.
2. Press **↓** to select *route name|ENT|↓* to **NAVIGATE|→** to **REVERSE|ENT|←** to **NAVIGATE|ENT**.
3. Upon arrival at your destination, cancel navigation: press **MENU|MENU|↓** to **CANCEL NAVIGATION|ENT|←** to **YES|ENT**.

Figure 1.

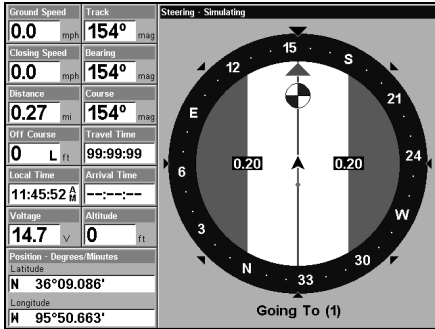

Figure 2.

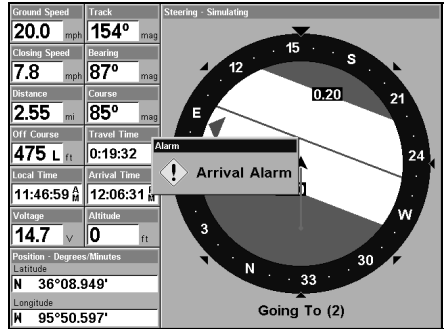

Figure 3.

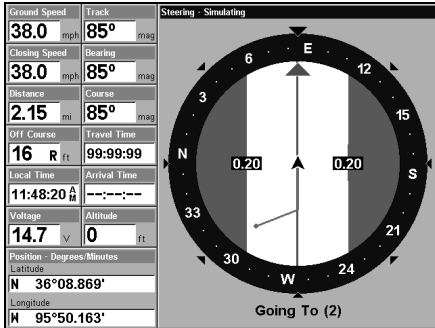
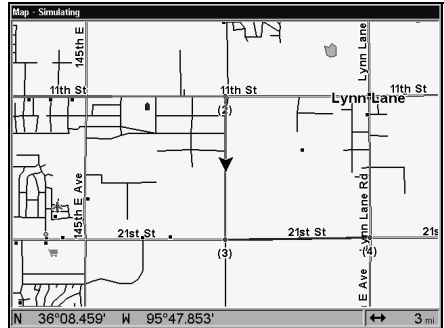

Figure 4.



Navigating a route: Fig. 1 shows the Navigation Page at the start of a route, heading straight for the first waypoint (Wpt 1). In Fig. 2, the traveler has arrived at Wpt 1; the arrival alarm has been triggered and the bearing arrow on the compass rose has turned to point toward Wpt 2, off to the east. In Fig. 3 the traveler has turned east on his new course and is heading straight for Wpt 2, which is 2.15 miles away. Fig. 4 shows route navigation on the Map Page. In this figure, the traveler has reached Wpt 2 and is half-way along the leg between Wpts 2 and 3.

Trails

Delete a Trail

This is the command used to erase or delete a trail: Press **MENU|MENU|↓** to **MY TRAILS|ENT|↓** to *trail name|ENT|→* to **DELETE TRAIL|ENT|←** to **YES|ENT**.

Tip:

You can also delete all trails at once:

1. Press **MENU|MENU|↓** to **MY TRAILS|ENT**.
2. Press **→** to **DELETE ALL|ENT|←** to **YES|ENT**.

Edit a Trail Name

To edit a trail name: press **MENU|MENU|↓** to **MY TRAILS|ENT|↓** to *trail name|ENT|ENT*. Press **↑** or **↓** to change the first character, then press **→** to the next character and repeat until the name is correct. Press **ENT** then **EXIT|EXIT|EXIT|EXIT** to return to the previous page display.

Tip:

You can quickly call up the Edit Trail menu by selecting a trail on the map with the cursor. Simply move the cursor over a trail and a pop-up box appears. Press **WPT** and the Edit Trail menu opens.

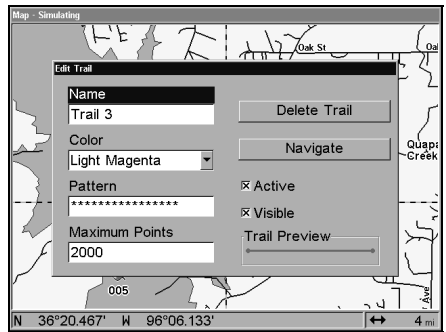
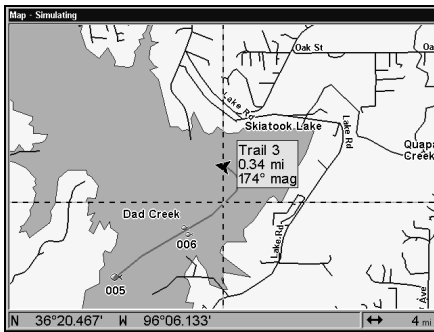

At left, trail selected with map cursor. The pop-up box shows distance and bearing from current position to the selected point on the trail. At right, the Edit Trail menu.

Edit a Trail Color

To edit a trail color: press **MENU|MENU|↓** to **MY TRAILS|ENT|↓** to *trail name|ENT|↓* to **COLOR|ENT**. Press **↑** or **↓** to select a color style, then press **ENT**. Press **EXIT|EXIT|EXIT|EXIT** to return to the previous page display.

Edit a Trail Pattern

To edit a trail pattern: press **MENU|MENU|↓** to **MY TRAILS|ENT|↓** to *trail name|ENT|↓* to **PATTERN|ENT**. Press **↑** or **↓** to change the first character,

then press → to the next character and repeat until the pattern is correct. Press **ENT**, then **EXIT|EXIT|EXIT|EXIT** to return to the previous page display.

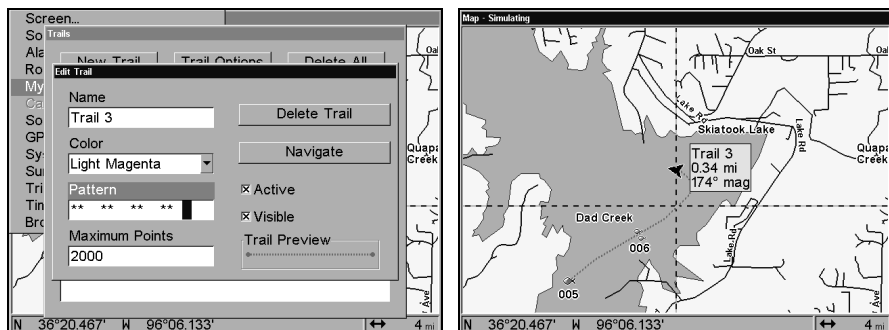

At left, Edit Trail Menu with Pattern option selected. At right, edited trail with dotted line pattern.

Utilities

Utilities are useful tools for traveling or for outdoor activities.

Alarm Clock

To get to the alarm clock menu: press **MENU|MENU|↓** to **TIMERS|ENT|↓** to **ALARM CLOCK|ENT**.

Sun/Moon Rise & Set Calculator

To get to the Sun/Moon menu: press **MENU|MENU|↓** to **SUN/MOON CALCULATIONS|ENT**.

Trip Calculator

To get to the Calculator menu: press **MENU|MENU|↓** to **TRIP CALCULATOR|ENT**.

Trip Down Timer

To get to the Down Timer menu: press **MENU|MENU|↓** to **TIMERS|ENT|↓** to **DOWN TIMER|ENT**.

Trip Up Timer

To get to the Up Timer menu: press **MENU|MENU|↓** to **TIMERS|ENT|ENT**.

Waypoints

Delete a Waypoint

To delete a waypoint from the waypoint list: press **WPT|ENT|ENT|ENT|↓** to *waypoint name*|**ENT|↓** to **DELETE WAYPOINT|ENT|←** to **YES|ENT**. To return to the previous page, press **EXIT|EXIT**.

To delete a waypoint from the map:

1. Use the arrow keys to select the waypoint with the cursor.
2. Press **WPT** | **→** to **DELETE WAYPOINT** | **ENT** | **←** to **YES** | **ENT**. To return to the previous page and clear the cursor, press **EXIT**.

To delete all waypoints at one time: press **MENU** | **MENU** | **↓** to **SYSTEM SETUP** | **ENT** | **↓** to **DELETE ALL MY WAYPOINTS** | **ENT** | **←** to **YES** | **ENT**. To return to the previous page, press **EXIT** | **EXIT**.

Edit a Waypoint

Waypoint Name

To edit waypoint name: 1. Press **WPT** | **ENT** | **ENT** | **ENT** | **↓** to *waypoint name* | **ENT** | **↓** to **EDIT WAYPOINT** | **ENT** | **ENT**.

2. Press **↑** or **↓** to change the first character, then press **→** to the next character and repeat until the name is correct. Press **ENT** then **EXIT** | **EXIT** | **EXIT** | **EXIT** to return to the previous page display.

Waypoint Symbol

To edit waypoint symbol: 1. Press **WPT** | **ENT** | **ENT** | **ENT** | **↓** to *waypoint name* | **ENT** | **↓** to **EDIT WAYPOINT** | **ENT** | **↓** to **CHOOSE SYMBOL** | **ENT**.

2. Use arrow keys to select desired symbol and press **ENT**. To return to the previous page, press **EXIT** | **EXIT** | **EXIT** | **EXIT**.

Waypoint Position

To edit waypoint position: 1. Press **WPT** | **ENT** | **ENT** | **ENT** | **↓** to *waypoint name* | **ENT** | **↓** to **EDIT WAYPOINT** | **ENT**.

2. Latitude: press **→** to **LATITUDE** | **ENT**. Press **↑** or **↓** to change the first character, then press **→** to the next character and repeat until the latitude is correct. Press **EXIT**.

3. Longitude: press **↓** to **LONGITUDE** | **ENT**. Press **↑** or **↓** to change the first character, then press **→** to the next character and repeat until the longitude is correct. Press **EXIT**.

4. When latitude and longitude are correct, return to the previous page: press **EXIT** | **EXIT** | **EXIT** | **EXIT**.

Selecting a Waypoint

To select a waypoint on the map (for navigating to, for editing, etc.,) use the arrow keys and center the cursor over the waypoint. A highlighted halo will appear around the waypoint.

Set a Waypoint by Average Position

This feature sets a waypoint at the current position after taking several position readings and averaging them. This boosts waypoint position

accuracy by helping to eliminate errors caused by atmospheric conditions and other factors.

1. Press **WPT** | → to **SUBCATEGORY** column | ↓ to **NEW** | **ENT**.
2. Press ↓ or ↑ to **AVERAGE POSITION** | **ENT** | press → to **CREATE** | **ENT**.
3. Wait while the unit takes points to average for the position. (The greater the number of points, the greater the accuracy.) When the desired number of points accumulates, press **ENT** to create and save the waypoint.
4. The Edit Waypoint menu appears. You can simply save the waypoint by pressing **EXIT** | **EXIT** or you can edit the waypoint.

Set a Waypoint by Projecting a Position

This feature sets a waypoint at a point located a specific distance and bearing from a reference position. The reference position can be selected from your waypoint list, a map feature or from the Points of Interest list.

1. Press **WPT** | → to **SUBCATEGORY** column | ↓ to **NEW** | **ENT**.
2. Press ↓ to **PROJECTED POSITION** | **ENT** | → to **CREATE** | **ENT**.
3. Press → to **CHOOSE REFERENCE** | **ENT**. Use ↑ and ↓ to select a waypoint, map feature or Point of Interest. When the point has been selected, press **ENT** and the point's position appears as the reference position.
4. Press ↓ to **DISTANCE** | **ENT**. Press ↑ or ↓ to change the first character, then press → to the next character and repeat until the distance is correct. Press **ENT**.
5. Press ↓ to **BEARING** | **ENT**. Press ↑ or ↓ to change the first character, then press → to the next character and repeat until the bearing is correct. Press **ENT**.
6. Press ↑ to **PROJECTION** | **ENT**. The Edit Waypoint menu appears. You can simply save the new projected waypoint by pressing **EXIT** | **EXIT** or you can edit the waypoint. (Press **EXIT** | **ENT** if you want to immediately begin navigating to the new waypoint.)

Section 8: System & GPS Setup Options

Alarms

This unit has several GPS alarms. The factory default setting has all the alarms turned on. You can turn the alarms off and on and change their distance settings.

You can set an arrival alarm to flash a warning message and sound a tone when you cross a preset distance from a waypoint. For example, if you have the arrival alarm set to 0.1 mile, then the alarm will flash a message when you come within 0.1 mile of the recalled waypoint.

The off course alarm warns you when your track drifts too far to the right or left of the course line to the waypoint. For example, if the alarm is set to 0.1 mile, then the alarm flashes a message if you drift 0.1 of a mile or more to the right or left of the line to the waypoint.

The anchor alarm is triggered when you drift outside of a preset radius. Again, using the 0.1 mile as an example, if you're anchored and your boat moves more than 0.1 mile, the alarm will flash a message and sound a tone.

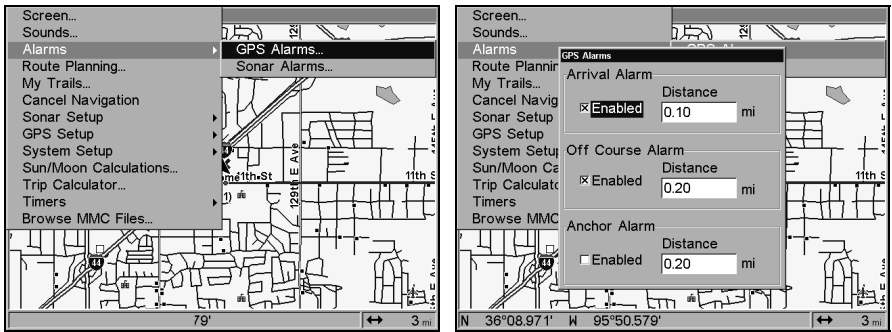

Alarms command, left; Alarm menu, right.

To change alarm settings:

1. Press **MENU | MENU | ↓** to **ALARMS | ENT**.
2. Scroll **↓** or **↑** to select the desired category, then press **ENT** to check or clear the Enabled box. This turns the alarm on (checked) or off (unchecked.)
3. To change distance settings, scroll **↓** or **↑** to select the desired category, then press **→ | ENT** to activate the distance dialog box. Press **↑** or **↓** to change the first character, then press **→** to the next character and repeat until the name is correct.

4. When your adjustments are finished, return to the last page displayed by repeatedly pressing **EXIT**.

IMPORTANT ALARM NOTES:

Anchor Alarm - The anchor alarm may be triggered even when you're sitting still. This typically happens when using small (less than 0.05 mile) anchor alarm ranges.

Arrival Alarm - If you set the arrival alarm's distance to a small number and you run a route (see the Navigate Routes segment), this unit may not show navigation data to the next waypoint, once you arrive at the first one, since you may not be able to come close enough to the first waypoint to trip the arrival alarm.

Auto Satellite Search

To lock onto the satellites, the GPS receiver needs to know its current position, UTC time and date. (Elevation (altitude) is also used in the equation, but it's rarely required to determine a position.) It needs this data so that it can calculate which satellites should be in view. It then searches for only those satellites.

When your GPS receiver is turned on for the first time, it doesn't know what your position or elevation (altitude) is. It does know the current UTC time and date since these were programmed into it at the factory and an internal clock keeps the time while the unit is turned off. (If the time and/or date are incorrect, you can set it using the "Set Local Time" menu.)

The unit begins searching for the satellites using the above data that it acquired the last time it was turned on. This probably was at the factory. Since it's almost certain that you're not at our factory, it's probably looking for the wrong satellites.

If it doesn't find the satellites it's looking for after approximately one minute, it switches to Auto Search. The receiver looks for any satellite in the sky. Due to advanced technology, the auto search time has shrunk significantly from the early days of GPS.

Once the unit locks onto the satellites, it should take less than a minute to find your position the next time it's turned on, provided you haven't moved more than approximately 100 miles from the last location it was used.

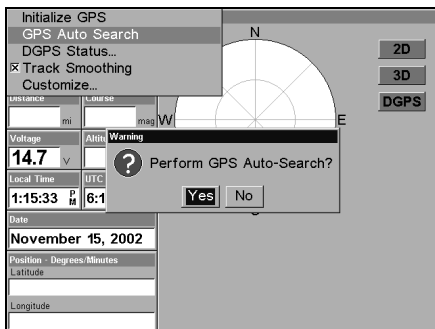
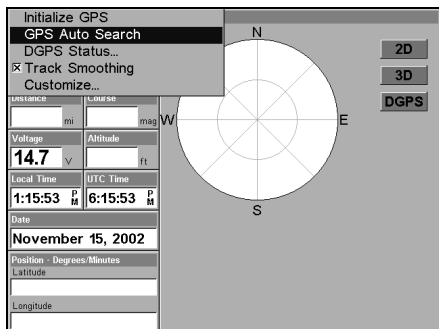

GPS Auto Search on the Satellite Status Menu.

You can force the unit to immediately kick into auto search mode. Here's how:

1. Press **PAGES** until you are on the Satellite Status screen.
2. Press **MENU** | ↓ to **GPS AUTO SEARCH** | **ENT** | ← to **YES** | **ENT**.

Check MMC Files and Storage Space

To check MMC Files:

Press **MENU** | **MENU** | ↓ to **BROWSE MMC FILES** | **ENT**.

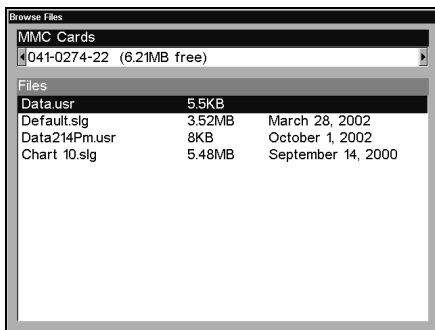
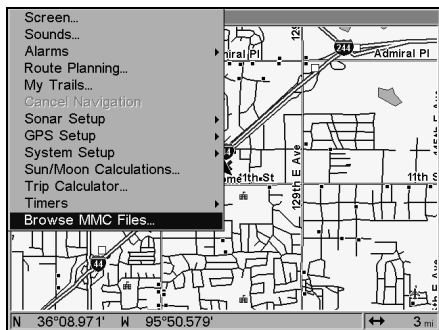

Main Menu, left, MMC File Browser, right.

Communications Port Configuration

The unit has two NMEA 0183 version 2.0 compatible communication ports, or com ports for short. The Com Port Menu, which is accessed from the System Setup Menu, allows you to configure the communications ports to send or receive data to another electronic device, such as an autopilot. Com port 1 can be used for either NMEA or DGPS Binary data transfer. Com port 2 is for NMEA output only.

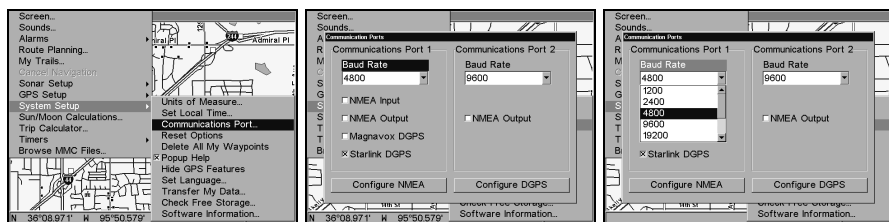

Menus for changing Com Port settings.

For connectors and wiring information for another device, see page 33. For assistance in configuring the unit to communicate with another device, consult the factory; customer service phone numbers are in the back of this manual. Also see the entries below for *Configure DGPS* and *Configure NMEA*. To set Com Port Configuration:

1. Press **MENU | MENU | ↓** to **SYSTEM SETUP | ENT.**
2. Press **↓** to **COMMUNICATIONS PORT | ENT.**

Configure DGPS

This unit will recognize Starlink[®], Magnavox[®] and Lowrance DGPS receivers.

1. Press **MENU | MENU | ↓** to **SYSTEM SETUP | ENT.**
2. Press **↓** to **COMMUNICATIONS PORT | ENT.**
 - A. If you have a Magnavox receiver, press **↓** to **MAGNAVOX | ENT.**
 - B. If you have a Lowrance or Starlink receiver, press **↓** to **STARLINK | ENT.**
 - C. If you have a Magnavox or Starlink, press **EXIT | EXIT | EXIT**. This is the only setup necessary. If you have a Lowrance receiver or another Magnavox- or Starlink- compatible brand, continue with these steps:
3. Press **↓** to **CONFIGURE NMEA | →** to **CONFIGURE DGPS | ENT.**
4. Press **ENT**, then use **↑ ↓ → ←** to enter the station frequency, then press **ENT**.
5. Press **→** to **BIT RATE | ENT** then use **↑ ↓** to select the station bit rate, then press **ENT**.
6. A. If you are *not* using a Starlink DGPS receiver, press **EXIT | EXIT | EXIT | EXIT** to return to the previous page.
 - B. If you *are* using a Starlink DGPS receiver, press **↓** to **STARLINK AUTO TUNING MODE |** press **ENT |** press **EXIT | EXIT | EXIT | EXIT** to return to the previous page.

Configure NMEA

You can configure the unit to use specific NMEA sentences.

1. Press **MENU | MENU | ↓ to SYSTEM SETUP | ENT.**
2. Press ↓ to **COMMUNICATIONS PORT | ENT | ↓ to CONFIGURE NMEA | ENT.**
3. A menu appears showing the prefixes of the available NMEA sentences. A check mark next to a prefix means the prefix is in use. Use ↑ ↓ → ← to select a prefix, then press **ENT** to turn off the prefix. (Press **ENT** again to check the box and turn a prefix on.)
4. When the desired prefixes are checked or unchecked, press **EXIT | EXIT | EXIT | EXIT** to return to the previous page.

Coordinate System Selection

The Coordinate System Menu lets you select the coordinate system to use when displaying and entering position coordinates.

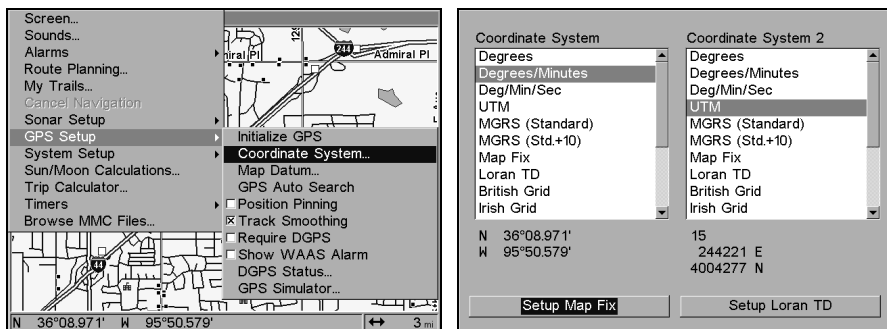

Menus for changing coordinate system used to display positions.

To get to Coordinate System Selection:

1. Press **MENU | MENU | ↓ to GPS SETUP | ENT.**
2. Press ↓ to **COORDINATE SYSTEM | ENT.**

This unit can show a position in degrees (36.14952°); degrees, minutes and thousandths of a minute ($36^\circ 28.700'$); or degrees, minutes, seconds and tenths of a second ($36^\circ 28' 40.9''$). It can also show position in: UTM (Universal Transverse Mercator) projection; MGRS (Standard); MGRS (Standard + 10); Map Fix; Loran TD; British, Irish, Finnish, German, New Zealand, Swedish, Swiss, Taiwan, Greek and Military grids.

UTM's are marked on USGS topographic charts. This system divides the Earth into 60 zones, each 6 degrees wide in longitude.

British, Irish, Finnish, German, New Zealand, Swedish, Swiss, Taiwan, and Greek grid systems are each the national coordinate system used only in their respective countries. In order to use these grid systems,

you must be in the respective country. This unit will pick the matching datum for you when you select the grid. See the entry on Map Datum Selection for more information.

The military grid reference system (MGRS) uses two grid lettering schemes, which are referred to as standard and standard + 10 MGRS on this unit. Your position and datum in use determines which one to use. If you use standard, and your position is off significantly, then try the alternate.

NOTE: When the position format is changed, it affects the way all positions are shown on all screens. This includes waypoints.

To change the coordinate system, press **ENT** while **COORDINATE SYSTEM** is highlighted. Press the \uparrow or \downarrow arrow keys to highlight the desired format. Press **ENT** to select it. Press **EXIT** to erase the menus.

To setup Loran TD:

NOTE:

If the Loran TD conversion is chosen, you must enter the local Loran chain identification for the master and slaves. Do this by selecting "Setup Loran TD" at the bottom of the "Coordinate System" menu and select the ID. Press **EXIT** to erase this menu.

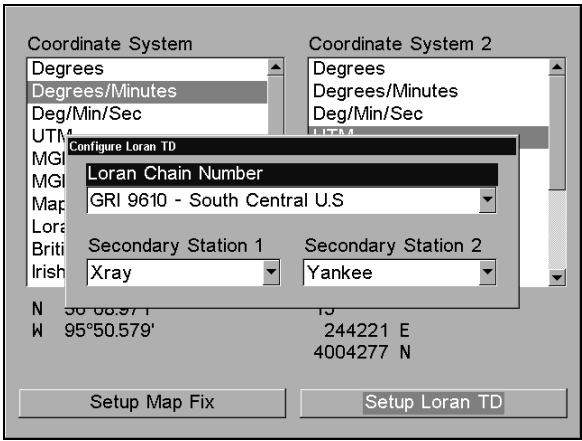

Configure Loran TD menu.

Map Fix

Map Fix is used with charts or maps. This system asks for a reference position in latitude/longitude, which you take from a marked location on the map. It then shows the present position as distance on the map from that reference point.

For example, if it shows a distance of UP 4.00" and LEFT 0.50", you then measure up four inches and to the left a half-inch from the reference point on the map to find your location.

To configure a map fix:

To use this format, you need to follow these steps in order. First, take your map of the area and determine a reference latitude/longitude. (Please note that in order for this system to work, the latitude/longitude lines must be parallel with the edge of the map. USGS maps are parallel, others may not be. Also, this works better with smaller scale maps.) The reference position can be anywhere on the map, but the closer it is to your location, the smaller the numbers will be that you'll have to deal with.

Once you've decided on a reference position, you can save it as a waypoint. See the waypoint section for information on saving a waypoint. Save the reference position as a waypoint. Exit from the waypoint screens.

1. Press **MENU | MENU | ↓** to **GPS SETUP | ENT**.
2. Press **↓** to **COORDINATE SYSTEM | ENT**.
3. Press **↓** to **SETUP MAP FIX | ENT**.

The following screen appears, and **MAP SCALE** is highlighted. Press **ENT** and enter the map's scale. This is generally at the bottom of the paper map. It's shown as a ratio, for example 1:24000. Press **EXIT** and the unit returns to the Configure Map Fix screen.

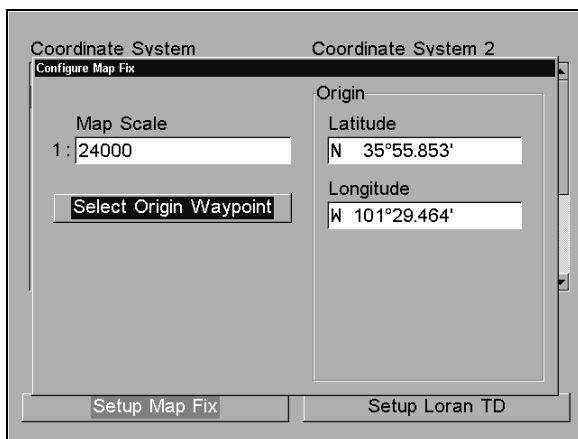

Configure a map fix so the LCX-104C can find your position on a printed chart or topographical map.

Press **↓** to **SELECT ORIGIN WAYPOINT|ENT|ENT|ENT** to bring up the waypoint list. Select the waypoint that you saved the reference point under and press **ENT**. The unit displays a waypoint information screen with the command **SET AS ORIGIN** selected; press **ENT** and the unit returns to the Configure Map Fix menu. Finally, press **EXIT** to erase this menu. Now press **↑** to **COORD SYSTEM|ENT**, select **MAP Fix** from the list and press **ENT|EXIT**. All position information now shows as a distance from the reference point you chose.

Customize Page Displays

The Status, Navigation, and Map pages all have customizable options. These options decide which information is viewable on each page.

Customize Satellite Status Page

While on the Satellite Status Page, press **MENU|↓** to **CUSTOMIZE|ENT**. Press **↓** or **↑** to select a display option window. With the display window highlighted and flashing, press **ENT** to open a list of options. Scroll **↑** and **↓** to select a different display option, then press **ENT**. After all options are set, press **EXIT** to return to the page display.

Customize Navigation Page

While on the Navigation Page, press **MENU|↓** to **CUSTOMIZE|ENT**. Press **↓** or **↑** to select a display option window. With the display window highlighted and flashing, press **ENT** to open a list of options. Scroll **↑** and **↓** to select a different display option, then press **ENT**. After all options are set, press **EXIT** to return to the page display.

Customize Map Page

While on the Map Page, press **PAGES|↓** or **↑** to select *Option Name|ENT*.

DGPS Status

The DGPS Status screen shows whether DGPS is off or on, and it describes the quality of the DGPS signal. This screen is useful if you have to diagnose a DGPS problem.

1. Press **MENU|MENU|↓** to **GPS SETUP|ENT|↓** to **DGPS STATUS|ENT**.
2. The DGPS Status screen is displayed. To return to the previous page, press **EXIT|EXIT|EXIT**.

GPS Simulator

The GPS simulator lets you use the unit as if you were outdoors navigating somewhere. It's a great way to practice using your unit. You can set the starting location by entering latitude/longitude (Starting Posi-

tion) or from a stored waypoint, map place or POI location (**CHOOSE START** command). You can steer your position and change speed on the map by using the arrow keys (**STEER WITH ARROWS** command) or by setting the track and speed in the dialog boxes provided on the simulator menu screen.

To get to the GPS Simulator:

1. Press **MENU | MENU | ↓** to **GPS SETUP | ENT**.
2. Press **↓** to **GPS SIMULATOR | ENT**. The GPS Simulator Menu appears.

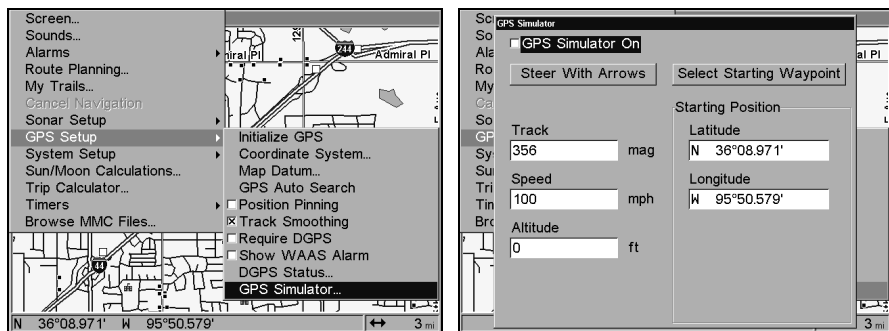

GPS Setup Menu, left; GPS Simulator menu, right.

Make the desired settings, then turn the simulator on by highlighting the **GPS SIMULATOR ON** box and pressing **ENT** key. Press **EXIT | EXIT | EXIT** to erase this menu. A message and tone appear periodically, warning you that the simulator is on. To turn the simulator off, repeat the above steps or turn the unit off.

While in simulator mode, you can press **EXIT** to clear the steering and speed boxes from the screen while continuing the simulation. This will allow you to use the map cursor during a simulation. To turn steering and speed boxes back on again, return to the GPS Simulator menu, select the **STEER WITH ARROWS** command, press **ENT**, then Press **EXIT | EXIT | EXIT** to return to the previous page.

Simulating Trail or Route Navigation

In Simulator mode, your unit can automatically follow a trail or route without manual steering if you use these steps:

1. From the Map Page, go to the simulator menu. Pick a **STARTING POSITION** at or near the beginning of your trail/route. Enter an approximate **TRACK** (shown in compass degrees) that will point you toward the start of the trail/route.
2. Set **SPEED** to zero. Select **STEER WITH ARROWS** command and press **ENT**, which turns on the simulator and returns you to the Map Page.

3. Begin navigating along the trail/route. (If you are close enough to the first waypoint, the arrival alarm will usually go off as soon as navigation begins. Press **EXIT** to clear the alarm.) When navigation starts, press **↑** to increase speed to the desired setting.

4. Press **EXIT** to turn off the steering and speed boxes. The unit will now automatically "steer" along the trail or route. When you arrive at your "destination," cancel navigation as you normally do.

Tip:

You can pick any spot on the map to begin your simulation session by using the Initialize GPS command. This makes your unit think it's located at the position you select. See it's entry following the entry for *Hide GPS Features*.

Hide GPS Features

If there is no GPS antenna/receiver module attached to this unit, the GPS menus and features can be hidden from view with this command. The default setting is off, allowing you to rotate between the Sonar Page and the GPS pages and features. To hide GPS features:

Press **MENU | MENU | ↓** to **SYSTEM SETUP | ENT | ↓** to **HIDE GPS FEATURES | ENT**. The GPS menus and pages are now hidden.

To restore GPS Features, press **MENU | MENU | ↓** to **SHOW GPS FEATURES | ENT**. The GPS menus and pages are available once again.

Initialize GPS

This command is handy when you are practicing in simulator mode. (See the entry in this section for *GPS Simulator*.) In simulator mode, this command makes the unit operate as if it is sitting someplace other than its actual location. So, you and your unit could be located in Kansas City, but easily practice navigating in the ocean off Islamorada, Florida.

1. Press **MENU | MENU | ↓** to **GPS SETUP | ENT | ENT**.

2. A message appears, telling you to move the cursor near the desired location and press **ENT**. When the message automatically clears, follow the message instructions.

3. In a moment, your present position marker arrow appears on the map in the location you selected with the cursor. The unit will consider that spot as it's last known position until changed by either a live satellite lock-on or a new simulator location.

Map Auto Zoom

This receiver has an auto zoom feature that eliminates much of the button pushing that other brands of GPS receivers force you to make. It works in conjunction with the navigation features.

First, start navigation to a waypoint. (See the waypoint section for more information on navigating to a waypoint.) Then, with the auto zoom mode on, the unit zooms out until the entire course shows, from the present position to the destination waypoint. As you travel toward the destination, the unit automatically begins zooming in — one zoom range at a time — always keeping the destination on the screen.

To turn this feature on, from the **MAP PAGE**, press **MENU** | ↓ to **AUTO ZOOM** | **ENT** | **EXIT**. Repeat these steps to turn it off.

Map Data

This menu lets you turn the map off, if desired (which turns the map screen into a GPS plotter); turn off or on the pop-up map info boxes; draw the map boundaries or boxes around the areas of high detail; or fill water areas with white. You can also turn on or off Map Overlays, which display latitude and longitude grid lines or range rings on the map. This menu lets you select Navionics Maps; for instructions, see the *Navionics Charts* entry in this section.

To get to Map Data:

From the Map Page, press **MENU** | ↓ to **MAP DATA** | **ENT**.

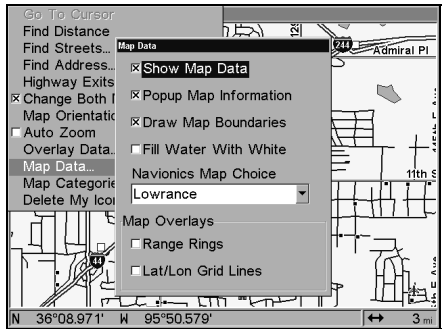
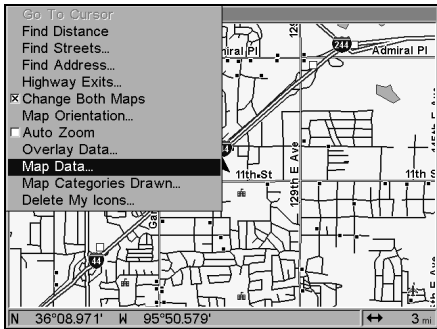

Map Menu, left, Map Data Menu, right.

Show Map Data

From the Map Page, press **MENU** | ↓ to **MAP DATA** | **ENT**. Press **ENT** to check **SHOW MAP DATA** (turn on) and uncheck it (turn off.) After the option is set, press **EXIT** | **EXIT** to return to the page display.

Pop-up Map Info

From the Map Page, press **MENU** | ↓ to **MAP DATA** | **ENT**. Press ↓ to **POPUP MAP INFO**. With the option highlighted, press **ENT** to check it (turn on) and uncheck it (turn off.) After the option is set, press **EXIT** | **EXIT** to return to the page display.

Map Boundaries

From the Map Page, press **MENU** | ↓ to **MAP DATA** | **ENT**. Press ↓ to **MAP BOUNDARIES**. With the option highlighted, press **ENT** to check it (turn on) and uncheck it (turn off.) After the option is set, press **EXIT** | **EXIT** to return to the page display.

Fill Water With White

From the Map Page, press **MENU** | ↓ to **MAP DATA** | **ENT**. Press ↓ to **FILL WATER WITH WHITE**. With the option highlighted, press **ENT** to check it (turn on) and uncheck it (turn off.) After the option is set, press **EXIT** | **EXIT** to return to the page display.

Map Overlays (Range Rings; Lat/Long Grid)

The map screen can be customized with four range rings and/or grids that divide the plotter into equal segments of latitude and longitude.

Range rings are handy for visually estimating distances on the map. The ring diameters are based on the current zoom range. For example: at the 100 mile zoom, the screen will show two rings with your current position in the center. The large ring touching the left and right sides of the screen is 100 miles in diameter (same as the zoom range). The second smaller ring is 50 miles in diameter (always 1/2 the zoom range).

The distance from your current position to the smaller ring (the ring's radius) is 25 miles (always 1/4 the zoom range). With the arrow keys and map cursor, you can scroll the map to see the third and fourth rings. In this example, the distance to the third ring is 75 miles and distance to the fourth ring is 100 miles from your current position.

To set range rings: From the Map Page, press **MENU** | ↓ to **MAP DATA** | **ENT**. Press ↓ to **RANGE RINGS**. With the option highlighted, press **ENT** to check it (turn on) and uncheck it (turn off.) After the option is set, press **EXIT** | **EXIT** to return to the page display.

To set Lat/Long Grid: From the Map Page, press **MENU** | ↓ to **MAP DATA** | **ENT**. Press ↓ to **LAT/LON GRID LINES**. With the option highlighted, press **ENT** to check it (turn on) and uncheck it (turn off.) After the option is set, press **EXIT** | **EXIT** to return to the page display.

Map Datum Selection

Maps and charts are based on a survey of the area that's covered by the map or chart. These surveys are called "Datums." Maps that are created using different datums will show the same latitude/longitude in slightly different locations.

All datums are named. The GPS system is based on the WGS-84 datum, which covers the entire world. Other datums may also cover the entire world, or just a small portion of it. By default, your position shows using the WGS-84 datum. However, it can show your position using one of 191 different datums. Different datums can be selected; to change the datum:

1. Press **MENU | MENU | ↓** to **GPS SETUP | ENT | ↓** to **MAP DATUM | ENT**.
2. Scroll **↓** or **↑** to select the desired datum, then press **ENT**.
3. To return to the last page displayed, press **EXIT | EXIT**.

A list of the datums used by this unit is in the back of this manual.

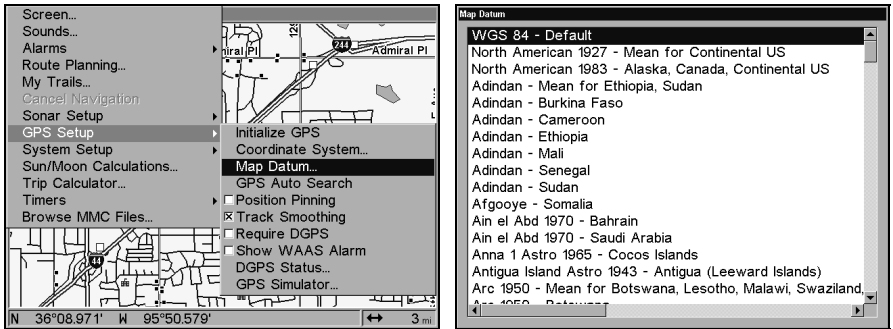

GPS Setup Menu, left, Map Datum Menu, right.

Map Detail Category Selection

This menu determines which of the mapping features are shown on the screen. This includes, waypoints, trails, icons, cities, highways, etc. You can selectively turn on or off any of these items, customizing the map to your needs.

To get to Map Categories:

1. From the Map Page, press **MENU | ↓** to **MAP CATEGORIES DRAWN | ENT**.
2. Press **↑** or **↓** to select a category or press **→** then press **↑** or **↓** to select a subcategory. Press **ENT** to turn it off (no check) or on (checked.)
3. To return to the last page displayed, press **EXIT | EXIT**.

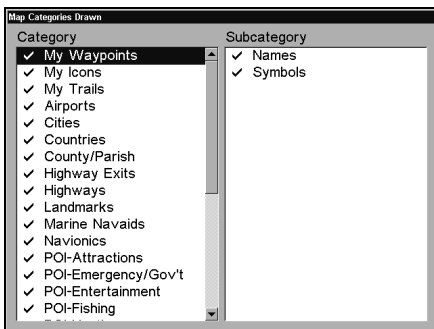
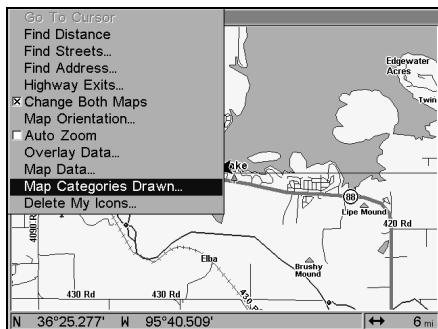

Map Menu, left, Map Categories Drawn Menu, right.

Map Orientation

By default, this receiver shows the map with north always at the top of the screen. This is the way most maps and charts are printed on paper.

In Track Up mode, map shows "N" and arrow to indicate north.

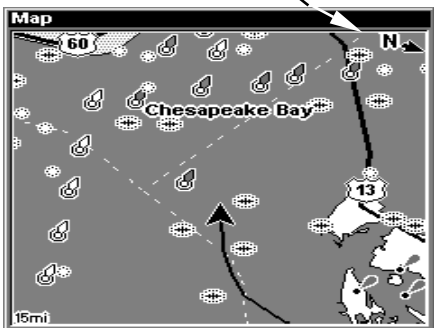
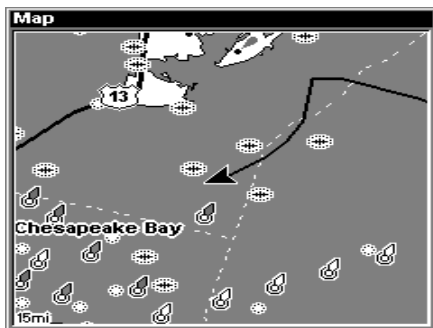

Map orientation at left is shown in north up and at right, track up.

This is fine if you're always traveling due north. What you see to your left corresponds to the left side of the map, to your right is shown on the right side of the map, and so on. However, if you travel any other direction, the map doesn't line up with your view of the world.

To correct this problem, a track-up mode rotates the map as you turn. Thus, what you see on the left side of the screen should always be to your left, and so on.

Another option is course-up mode, which keeps the map at the same orientation as the initial bearing to the waypoint. When either the track-up or course-up mode is on, an "N" shows on the map screen to help you see which direction is north.

To change map orientation: from the Map Page, press **MENU** | **↓** to **MAP ORIENTATION** | **ENT**. Use **↑** or **↓** to select the desired mode, then press **ENT**. Press **EXIT** | **EXIT** to return to the page display.

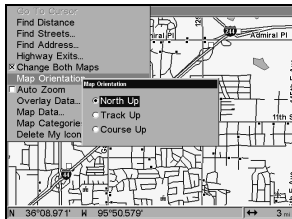
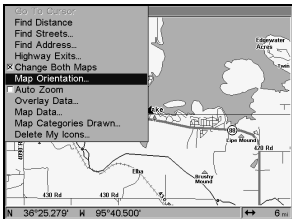

Map Menu, left; Map Orientation menu with the North Up map orientation option selected, right.

Overlay Data

To change the digital data shown on top of the Sonar Page or the Map Page:

First, press **PAGES**, use \rightarrow or \leftarrow to select a *Page Name*, then press **EXIT**.

To select data for display:

1. From the Map or Sonar page, press **MENU** | \downarrow to **OVERLAY DATA** | **ENT**.
2. Press \downarrow or \uparrow to select *Data Type* | **ENT**.

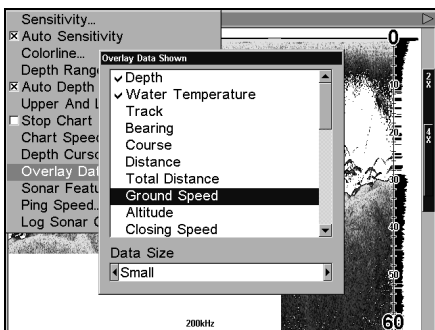
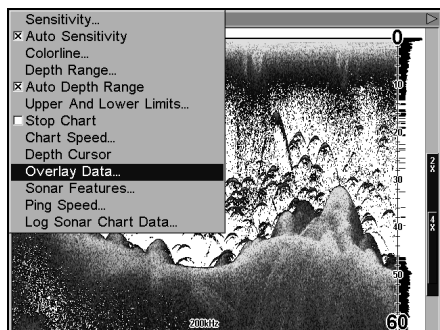

Overlay Data command on the Sonar Menu, at left. Overlay Data Shown selection menu, right. In this example, we scrolled down the data list to highlight "Ground Speed."

When selected, the data type shifts to the top of the data list and a check mark appears beside the data type. (If you wish, you may now use \downarrow or \uparrow to select other Data Types for display.)

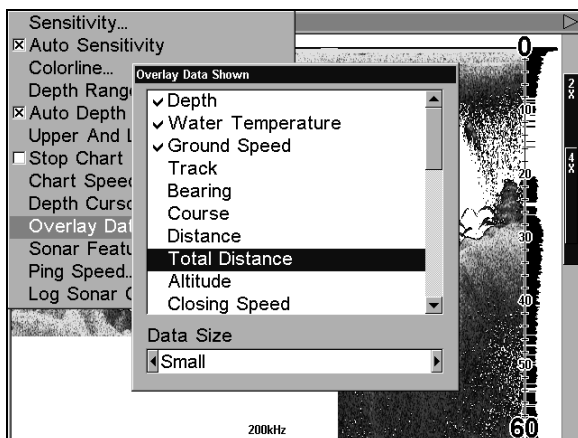

Data list showing "Ground Speed" selected to display on Sonar Page.

3. To return to the previous page, press **EXIT | EXIT**.

To turn off displayed data:

1. From the Map or Sonar page, press **MENU | ↓** to **OVERLAY DATA | ENT**.

2. Press **↓** or **↑** to select *Data Type* | **ENT**. The selected data type disappears from the top of the list and reverts to its previous, unchecked position. (If you wish, you may now use **↓** or **↑** to select other Data Types to turn off.)

3. To return to the previous page, press **EXIT | EXIT**.

To change displayed data font size:

1. From the Map or Sonar page, press **MENU | ↓** to **OVERLAY DATA | ENT**.

2. Press **↓** or **↑** to select *Data Type* | press **→** or **←** to *Data Size* | **EXIT**.

The selected data type will be displayed in the new size. (To change the font size for another Data Type, press **ENT** and repeat these steps, beginning with step two above.)

3. To return to the previous page, press **EXIT**.

Tip:

If you wish, you can change the displayed data font size when you select a data type:

1. From the Map or Sonar page, press **MENU | ↓** to **OVERLAY DATA | ENT**.

2. Press **↓** or **↑** to select *Data Type* | press **→** or **←** to select *Data Size* | **ENT**.

The data will be shown in the new font size. To return to the previous page, press **EXIT | EXIT**.

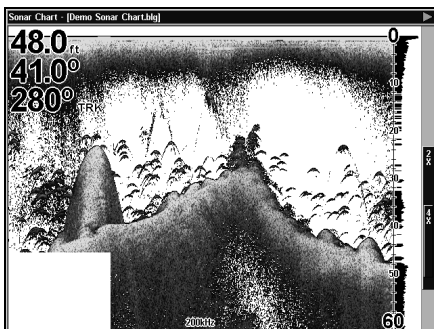
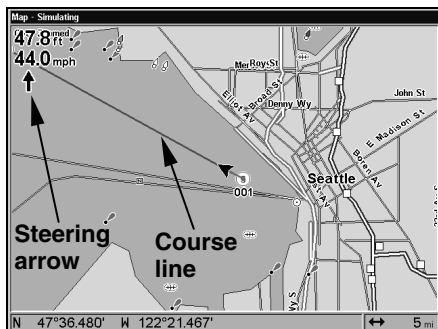

At left, Map Page showing boat cruising Puget Sound, Washington, with Overlay Data turned on. This example shows Depth, Ground Speed and the Steering Arrow. Note that the Steering Arrow always points directly to the destination you are navigating toward. In this case, the boater is headed on a northwesterly course of 280°. Since the helmsman is on course, the Steering Arrow is pointing straight ahead. If the helmsman veered off course, the arrow would show which direction to steer to get back on course toward the destination. At right, Sonar Page with Overlay Data turned on. This example shows Depth, Ground Speed and the Track the boat is following.

Navionics® Charts

Your LCX-104C can display Navionics® electronic charts on MMCs. They work just like a MapCreate custom map on an MMC.

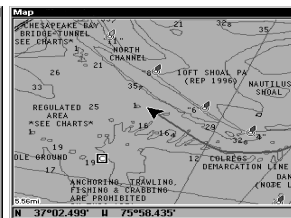
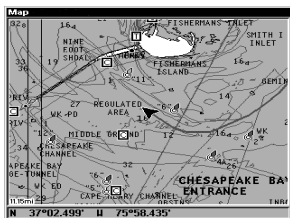
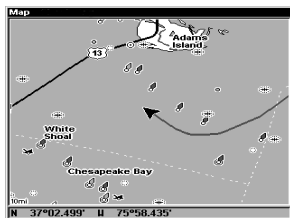

Left, entrance to Chesapeake Bay in a MapCreate 6 custom map, 10 mile zoom. Center, same position on Navionics chart at 11.15 mile zoom and right, 5.56 mile zoom.

To display a Navionics chart:

1. Install the Navionics MMC in the memory card compartment and turn on the unit. (For full card install instructions, see Sec. 2.)

WARNING:

You should never format the MMC containing your Navionics chart. Formatting the MMC will permanently erase the chart from the card.

2. From the Map Page, press **MENU** | ↓ to **MAP DATA** | **ENT** | ↓ to **MAP CHOICE** | **ENT**. Use ↑ or ↓ to select the *Map Name*, then press **ENT** | **EXIT** | **EXIT**.

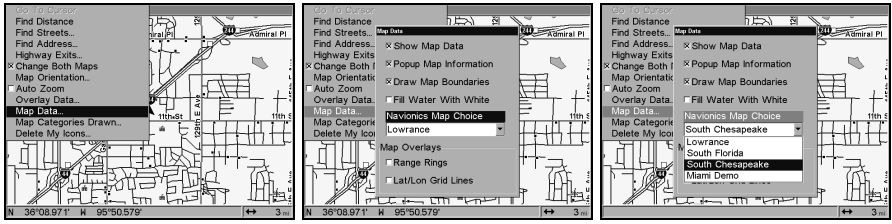

These figures show menu sequence (from left to right) for selecting a Navionics chart for the South Chesapeake Bay area.

3. To turn off a Navionics chart, From the Map Page, press **MENU** | ↓ to **MAP DATA** | **ENT** | ↓ to **MAP CHOICE** | **ENT**. Use ↑ or ↓ to select **LOWRANCE**, then press **ENT** | **EXIT** | **EXIT**.

Port Information

Navionics charts contain Port Services information, represented by anchor icons on the map display. An example is displayed in the following figure.

To view Port Services information:

1. Use the arrow keys to move the cursor over a Port Services icon. When selected, a pop-up name box appears.
2. Press **WPT** to display the Port Services Information screen.

The Port Services information screen has two windows. The top window lists the various service categories. The lower window lists the detailed services available in each basic category.

Port Services icons

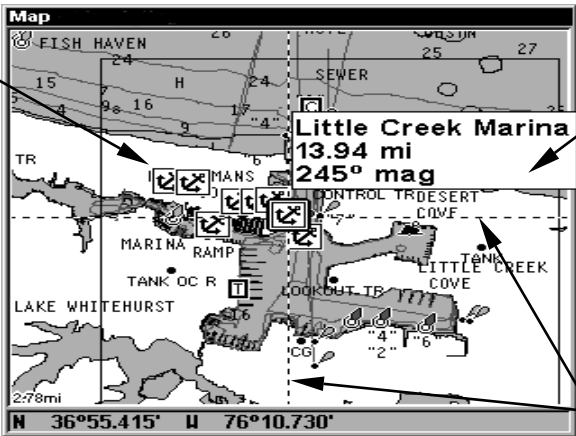

Pop-up name box

Cursor lines

Navionics chart showing Port Services icon selected by cursor.

3. To scroll through the Service Categories window: press **ENT** then use **↑** or **↓** to see the types of services available. As you highlight a different category, the list in the lower window changes. To return to the Map Page, press **EXIT | EXIT**.

4. The General Services category includes a long list of items in the Detailed Services window. To scroll through the Detailed Services window: from **SERVICE CATEGORIES**, press **↓** to **DETAILED SERVICES | ENT**, then use **↑** or **↓** to read the list of available services. To return to the Map Page, press **EXIT | EXIT**. To return to the top service category window, press **ENT | ↑**.

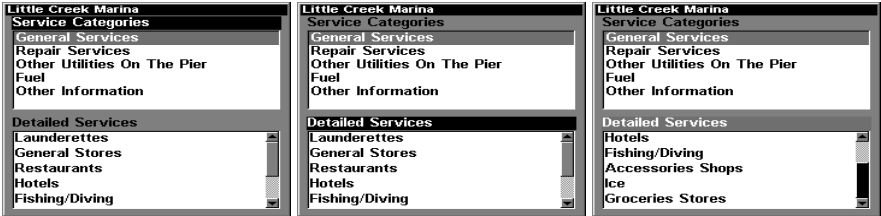

Port Services information screens.

Tidal Current Information

Navionics charts contain Tidal Current information, represented at large zoom ranges by a box icon with the letter "C." The icon stands for a Tidal Current Station location. An example is displayed at right.



When you zoom in to a sufficiently small zoom range, the icon itself becomes an animated arrow showing tidal current velocity and direction *for the selected tidal station* at the present time. At larger zoom ranges, you can select the boxed "C" icon and it becomes an animated arrow with a pop-up name box. An example is displayed in the following figure.

To view Tidal Current information:

1. Use the arrow keys to move the cursor over a Tidal Current Station icon. When selected, a pop-up name box appears.
2. Press **WPT** to display the Tidal Current Information screen.

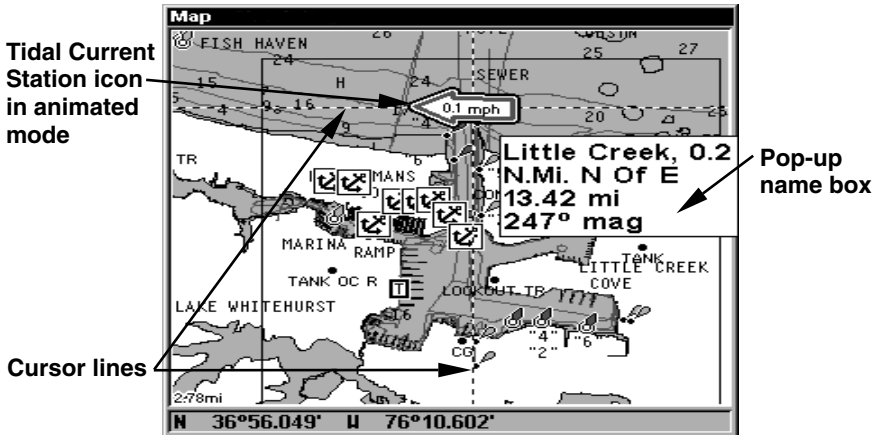

Navionics chart showing Tidal Current Station icon selected by cursor. In this example, the tidal current is in flood but it's about to enter the slack water stage. The current is flowing to the west at 0.1 mph.

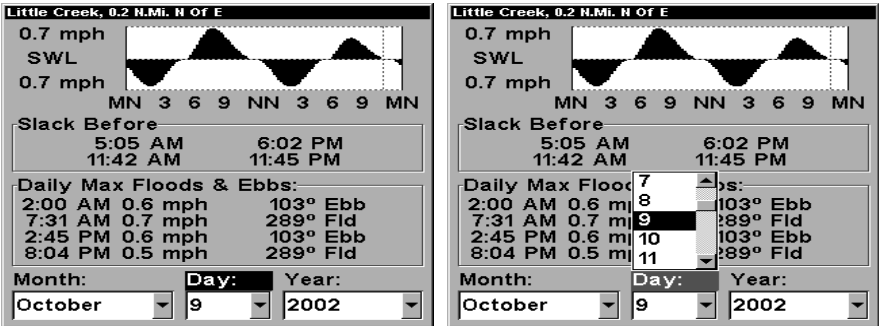

Current Information screen.

The Tidal Current Information screen displays daily tidal current data for this station on this date at the present time. The graph at the top of the screen is an approximate view of the flood and ebb pattern for the day, from midnight (MN), to noon (NN) to midnight (MN). The velocity scale at the top left side of the graph changes dynamically based upon the maximum velocity of the current for that day.

Slack water, the period of little or no current, is represented by the Slack Water Line (SWL). The flood appears above the SWL and the ebb appears below the SWL.

You can look up tidal current data for other dates by changing the month, day and year selection boxes. To select another date:

1. Use → and ← to highlight month, day or year, then press **ENT**.
2. Use ↑ and ↓ to select the desired month, day or year, then press **ENT**.

To clear the information screen, press **EXIT**.

Tide Information

Navionics charts contain Tidal Information, represented at large zoom ranges by a box icon with the letter "T." The icon stands for a Tidal Station location. An example is displayed at right.

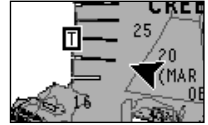

When you zoom in to a sufficiently small zoom range, the icon itself becomes an animated gauge showing a rising or falling tidal height for the selected station at the present time. At larger zoom ranges, you can select the boxed "T" icon and it becomes an animated gauge with a pop-up name box. An example is displayed in the following figure.

To view tide information:

1. Select a Tide Station icon: use the arrow keys to move the cursor over an icon. When it is selected, a pop-up name box appears.
2. After selecting the Tide Station icon, press **WPT** to display the Tide Information screen.

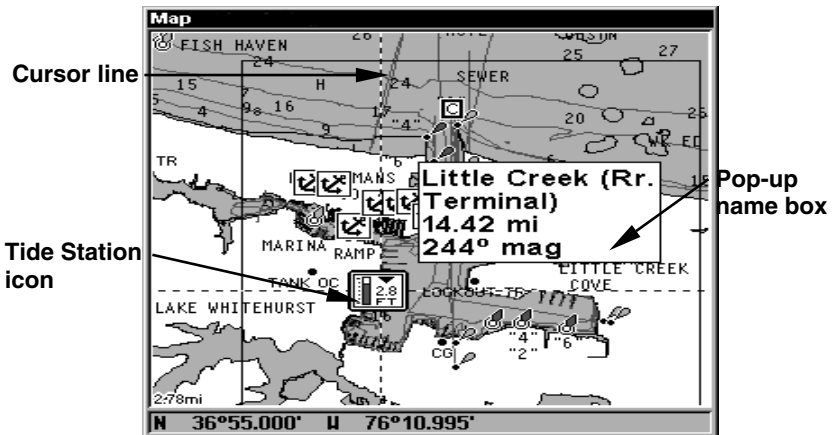

Navionics chart showing Tide Station icon selected by cursor. In the example above, the tide is at 2.8 feet and falling, as shown by the down arrow at the top of the icon.

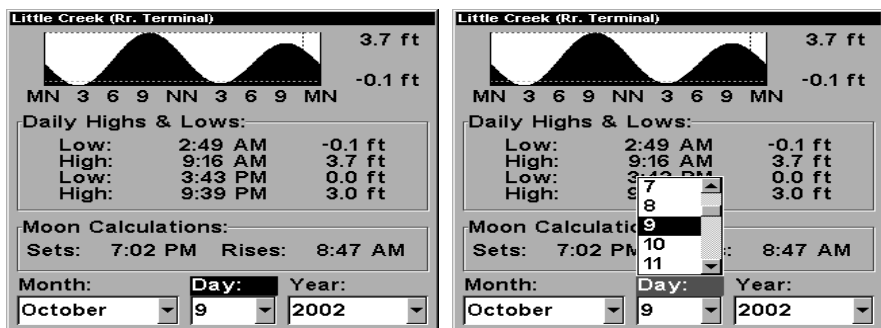

Tide Information screen.

The Tide Information screen displays daily tidal data for this station on this date at the present time. The graph at the top of the screen is an approximate view of the tidal range pattern for the day, from midnight (MN), to noon (NN) to midnight (MN). The dotted line across the graph is the Mean Lower Low Water line (MLLW).

The height scale on the top right side of the graph changes, based upon the maximum *range* of the tide for that day. The MLLW line also adjusts its position as the height scale changes.

You can look up tidal data for other dates by changing the month, day and year selection boxes. To select another date:

1. Use → and ← to highlight month, day or year, then press **ENT**.
2. Use ↑ and ↓ to select the desired month, day or year, then press **ENT**.

To clear the information screen, press **EXIT**.

Pop-up Help

Help is available for virtually all of the menu labels on this unit. By highlighting a menu item and leaving it highlighted for a few seconds, a "pop-up" message appears that describes the function of the menu item. This feature is on by default.

To set up Popup Help: Press **MENU | MENU | ↓** to **SYSTEM SETUP | ENT | ↓** to **POPUP HELP**. With the option highlighted, press **ENT** to check it (turn on) and uncheck it (turn off.) After the option is set, press **EXIT | EXIT** to return to the page display.

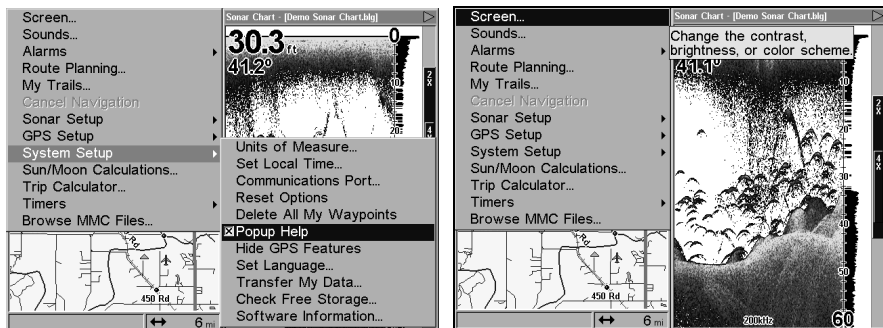

System Setup menu, left, with Pop-up Help command highlighted. At right, this example shows the Pop-up Help message for the Screen command, located on the Map Menu.

Position Pinning

When you are standing still or moving at extremely slow speed, a GPS receiver can have trouble determining the direction you are traveling. In the past, this resulted in a "wandering" plot trail that moved around the map, even if you were standing still.

The Position Pinning feature was developed so that when you stopped, the unit locked the present position on the GPS plotter until you moved a short distance or exceeded a very slow speed.

The command remains available in the unit's software, but we recommend that you leave it in the default off (unchecked) mode. The "wandering" plot trail issue has now been corrected by the Track Smoothing feature. Turning on Position Pinning could actually result in an inaccurate plot trail if you are moving around in a relatively small area. If you want to experiment with Position Pinning, the same instructions are used to turn the feature on (checked) and off (unchecked.)

1. Press **MENU | MENU | ↓ to GPS SETUP | ENT | ↓ to POSITION PINNING | ENT.**
2. Press **EXIT | EXIT** to return to the previous page.

Reset Options

To reset all features to their factory defaults:

Press **MENU | MENU | ↓ to SYSTEM SETUP | ENT | ↓ to RESET OPTIONS | ENT | ← to YES | ENT.**

NOTE:

Reset Options does *not* erase any waypoints, routes, icons, plot trails or sonar logs.

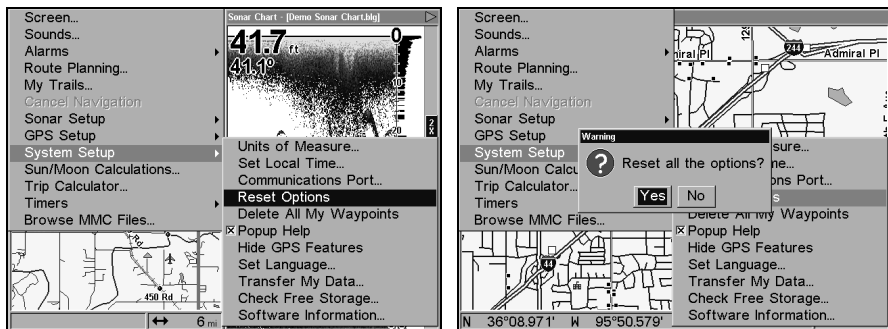

Reset Options command, left,
and the Reset Options Menu, right.

Require DGPS

You can force the LCX-104C to require DGPS for reporting a valid position. (The default setting, off, uses DGPS automatically when an optional DGPS beacon receiver is connected. However, this auto mode doesn't *require* DGPS reception to yield a position.) Here's how to turn *mandatory* DGPS on and off.

1. Press **MENU | MENU | ↓** to **GPS SETUP | ENT | ↓** to **REQUIRE DGPS | ENT**.
2. To return to the last page displayed, press **EXIT | EXIT**.
3. You can return to this command and press **ENT** again to turn the feature off.

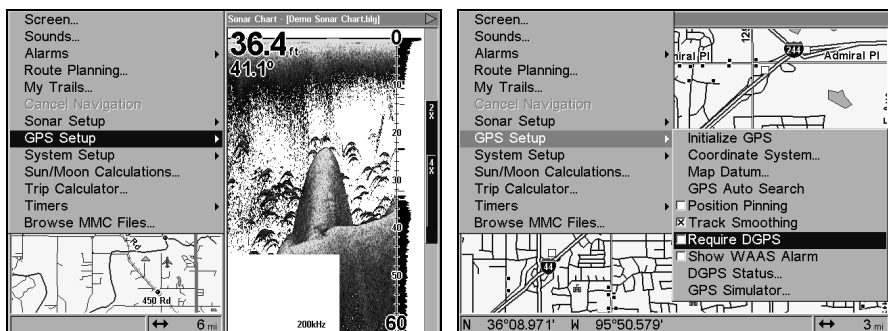

GPS Setup command, left; Require DGPS
command on the GPS Setup Menu, right.

Screen Contrast and Brightness

To access the Screen menu, press **MENU | MENU | ENT**.

Once in the Screen menu:

To adjust the display's contrast:

The **CONTRAST** slider bar is already selected. Press → or ← to move the bar. The left end of the scale is minimum contrast; the right end is maximum contrast.

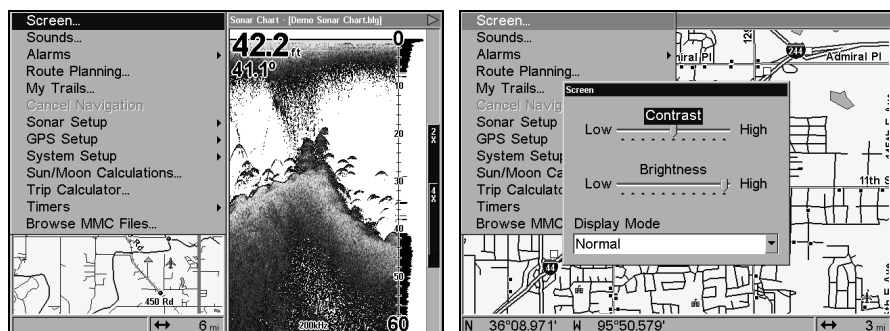

Screen Command, left, and Screen Menu with Contrast bar selected, right.

To adjust the display's brightness:

Press ↓ to **BRIGHTNESS**. Press → or ← to move the bar. The left end of the scale is minimum contrast; the right end is maximum contrast.

To adjust the screen's display mode:

Press ↓ to **DISPLAY MODE | ENT** | press ↑ or ↓ to select *mode* | **EXIT**.

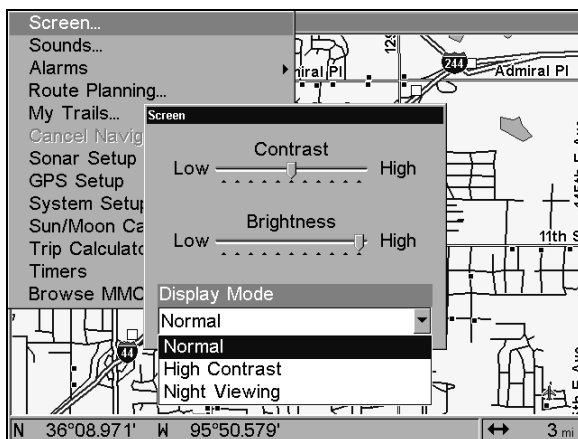

Display Mode menu.

Set Language

This unit's menus are available in 10 languages: English, French, German, Spanish, Italian, Danish, Swedish, Russian, Dutch and Finnish. To select a different language:

1. Press **MENU | MENU | ↓** to **SYSTEM SETUP | ENT**.
2. Press **↓** to **SET LANGUAGE... | ENT**.
3. Use **↓** or **↑** to select a different language and press **ENT**. All menus now appear in the language you selected.

Set Local Time

Using the correct local time setting is handy when estimating local arrival time while navigating. Also, the time and date are saved when a waypoint is created.

To access the Set Local Time menu, you must first acquire your position. Once that is done: press **MENU | MENU | ↓** to **SYSTEM SETUP | ENT | ↓** to **SET LOCAL TIME | ENT**.

Once in the Time Settings menu:

To set Local Time: Press **ENT**. Press **↑** or **↓** to change the first character, then press **→** to move the cursor to the next character. Repeat until the time is correct, then press **ENT**.

To set the Month: Press **↓** to **MONTH | ENT**. Press **↑** or **↓** to select the month, then press **ENT**.

To set the Day: Press **→** to **DAY | ENT**. Press **↑** or **↓** to select the day, then press **ENT**.

To set the Year: Press **→** to **YEAR | ENT**. Press **↑** or **↓** to select the year, then press **ENT**.

The last field in this menu is **CONFIG DST**. This feature allows your unit to automatically adjust with the time change caused by Daylight Saving Time (you should only have to set it once). You may select which set of rules matches DST in your region, or simply accept the default.

Once you have each field set the way you want, press **EXIT** repeatedly until you return to the previous page.

Show WAAS Alarm

When the signal is available, your unit will automatically use WAAS to boost the accuracy of the position fix. When the WAAS signal is lost or acquired, an alarm message appears. Since the U.S. government is still developing the WAAS system, it's not unusual for a GPS/WAAS receiver to frequently lose and reacquire its lock on a WAAS satellite. That can result in the alarm repeatedly going on and off. If you want, you have the option of turning off the WAAS Acquired/Lost alarm without affecting how the unit uses WAAS. Here's how:

1. Press **MENU | MENU | ↓** to **GPS SETUP | ENT | ↓** to **SHOW WAAS ALARM**.

2. With the option highlighted, press **ENT** to uncheck it (turn off) and check it (turn on). After the option is set, press **EXIT|EXIT** to return to the page display.

3. You can return to this command and press **ENT** again to turn the feature on.

Software Version Information

From time to time, Lowrance updates the operating system software in some of its products. These software upgrades are usually offered to customers as free downloads from our web site, www.lowrance.com. These upgrades make the unit perform better or introduce a new feature or function. You can find out what software version is running in your LCX-104C by using the Software Information command.

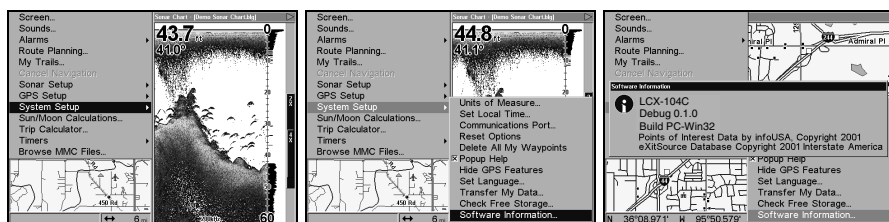

System Setup command left; Software Information command, center.
At right, the Software Information screen.

1. Press **MENU|MENU|↓** to **SYSTEM SETUP|ENT|↓** to **SOFTWARE INFO|ENT**.
2. Read the information displayed on the screen.
3. To return to the last page displayed, press **EXIT|EXIT|EXIT**.

Sounds and Alarm Sound Styles

Sounds triggered by key strokes and alarms can be adjusted:

You first press **MENU|MENU|↓** to **SOUNDS|ENT**.

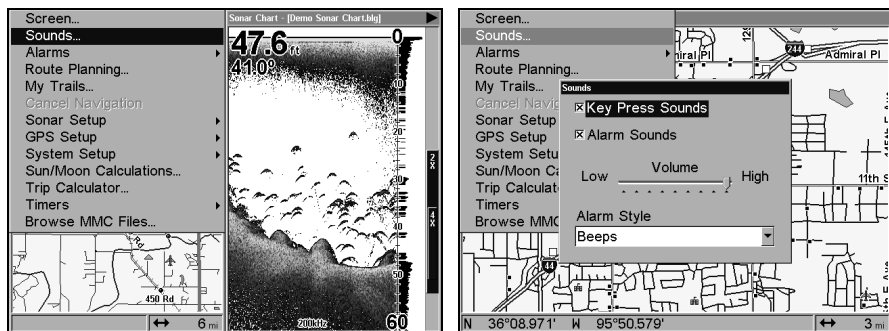

Sounds command, left. At right, the Sounds menu.

Once in the Sounds menu:

To set Key Press Sounds: With the option highlighted, press **ENT** to check it (turn on) and uncheck it (turn off). After the option is set, press **EXIT | EXIT** to return to the page display.

To set Alarm Sounds: Press **↓** to **ALARM SOUNDS**. With the option highlighted, press **ENT** to check it (turn on) and uncheck it (turn off). After the option is set, press **EXIT | EXIT** to return to the page display.

To set Alarm Volume: Press **↓** to **VOLUME**. Press **→** or **←** to move the bar. The left end of the scale is low volume; the right end is high volume. After the option is set, press **EXIT | EXIT** to return to the page display.

To set Alarm Style: Press **↓** to **ALARM STYLE | ENT**. Press **↑** or **↓** to change the style, then press **ENT**. After the option is set, press **EXIT | EXIT** to return to the page display.

Track Smoothing

This is a factory setting on the GPS Setup menu that *should always be left on*. When stopped or traveling at slow speeds (such as walking or trolling), Track Smoothing prevents wandering of trails, the steering arrow, compass rose and a map in track-up mode.

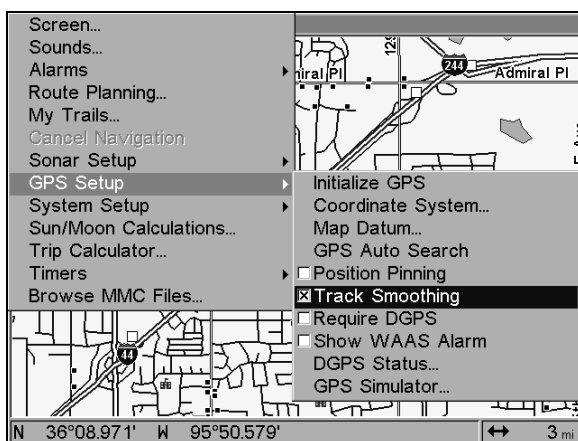

Track Smoothing option, turned on.

Trail Options

There are several options you can use with trails. Some affect all trails, other options can be applied to a particular trail. You can change the way trails are updated, you can display or hide trails, create a new trail, delete a trail, etc.

General Trail Options

To access the Trails Menu:

Press **MENU | MENU | ↓** to **MY TRAILS | ENT**.

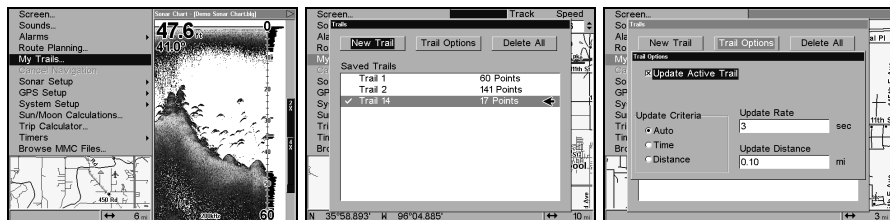

Main Menu, left, Trails Menu, center, Trail Options, right.

Delete All Trails

To remove all of the trails from memory: from the Trails Menu, press → to **DELETE ALL** | **ENT** | ← to **YES** | **ENT**.

Update Trail Option

This menu lets you change the way the trail updates occur.

WARNING:

If you *uncheck* the Update Trail option, automatic trail creation and recording will be turned *off*. You must turn it back on to record trails. The default setting is on.

From the Trails Menu, press → to **OPTIONS** | **ENT**. With **UPDATE ACTIVE TRAIL** highlighted, press **ENT** to check it (turn on) and uncheck it (turn off).

Update Trail Criteria (Auto, Time, Distance)

The options are automatic, time, or distance. When it's in the default automatic mode, the unit doesn't update the plot trail while you're traveling in a straight line. Once you deviate from a straight line, the unit "drops" a plot point (trail waypoint) onto the trail. This conserves plot trail points. If a plot trail uses all of the available points allotted to it, the beginning points are taken away and placed at the end of the trail.

From the Trails Menu, press → to **OPTIONS** | **ENT** | ↓ to **UPDATE CRITERIA**. Press ↑ or ↓ to select *criteria type* | **ENT**. If you selected Time, the Update Rate data entry box appears on the menu. If you selected Distance, the Update Distance data entry box appears on the menu.

Trail Update Rate (Time, Distance)

You can update a trail by time, with a range from 1 second to 9999 seconds; the default is 3 seconds. You can update by distance, with a range from 0.01 mile/nm/km to 9.99 mile/nm/km; the default is 0.10 miles.

With one of the Update Criteria selected, use the cursor arrows to highlight either the **UPDATE RATE** or **UPDATE DISTANCE** data entry boxes and press **ENT**. Press ↑ or ↓ to change the first character, then press → to the next character and repeat until the entry is correct. Press **EXIT** to return to the Trail Options Menu.

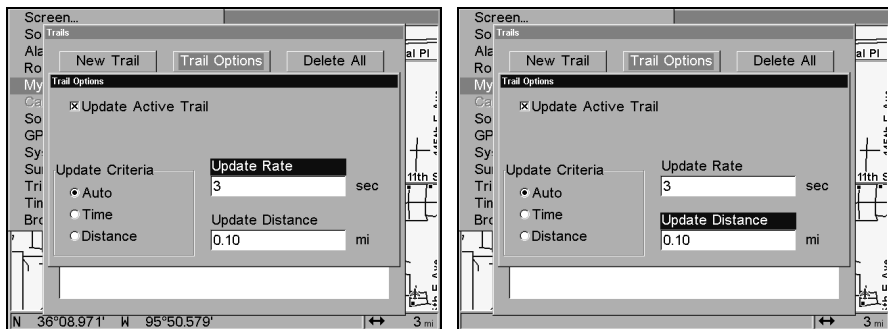

Trail Options menu: Update Time Rate setting, left, and Update Distance setting, right.

Specific Trail Options

Delete Trail

To delete a specific trail: From the Trails Menu, press ↓ to *Trail Name* | **ENT**. The Edit Trail menu appears as seen in the following figure. Press → to **DELETE TRAIL** | **ENT** | ← to **YES** | **ENT**.

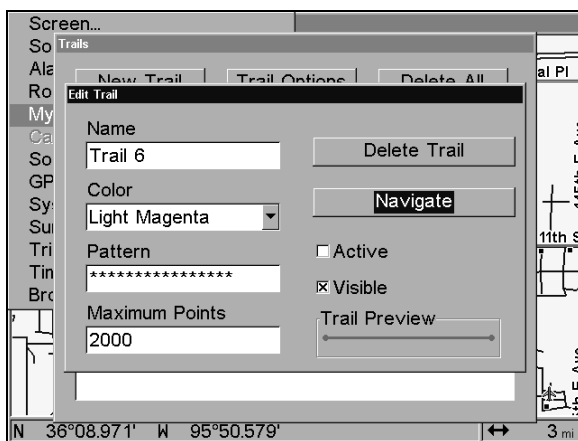

Edit Trail menu.

New Trail

To manually start a new trail, in the Trails Menu, make sure **NEW TRAIL** is highlighted and press **ENT** | **EXIT**.

Trail Visible/Invisible and Other Trail Options

The name, maximum number of points in the trail, activity, and visibility are all changed on the Edit Trail menu screen. The Active setting determines whether or not the unit is recording new points for a particular trail.

On the Edit Trail menu, press ↓ or ↑ to highlight the section you wish to change, then press **ENT**. Make your changes, then press **EXIT** to erase this menu.

You can also change the trail line color and pattern. For instructions, see the entries on Edit a Trail Color and Edit a Trail Pattern beginning on page 131, Sec. 7, Advanced GPS Operations.

Units of Measure

This menu sets the speed and distance (statute or nautical miles, meters), depth (feet, fathoms, or meters), temperature (degrees Fahrenheit or Celsius) and heading (true or magnetic) units. To change the units:

Press **MENU | MENU | ↓** to **SYSTEM SETUP | ENT | ENT**.

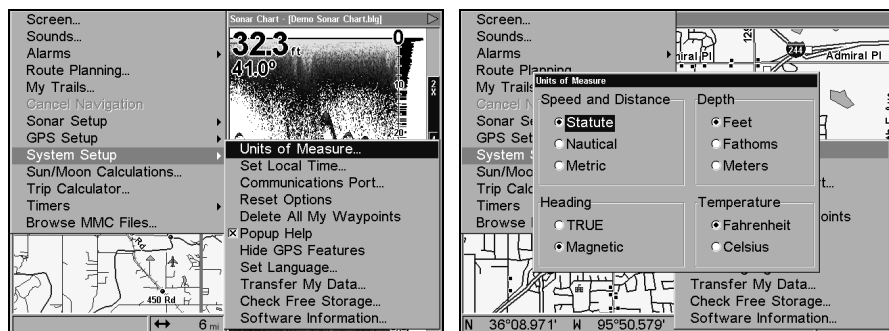

System Setup Menu, left, Units of Measure Menu, right.

To set Speed/Distance Unit of Measure: Press ↑ or ↓ to change the Speed/Distance, then press **ENT**. After the option is set, press **EXIT | EXIT | EXIT** to return to the page display.

To set Heading: Press ↑ or ↓ to change the heading type, then press **ENT**. After the option is set, press **EXIT | EXIT | EXIT** to return to the page display.

To set Depth: Press → to **DEPTH**. Press ↑ or ↓ to change the heading type, then press **ENT**. After the option is set, press **EXIT | EXIT | EXIT** to return to the page display.

To set Temperature: Press → ↓ to **TEMPERATURE**. Press ↑ or ↓ to change the heading type, then press **ENT**. After the option is set, press **EXIT | EXIT | EXIT** to return to the page display.

Notes

Section 9: Searching

NOTE:

The background map loaded in your unit lets you search for U.S. Interstate Highway exits and exit services, as well as some land features, including cities and lakes. For a full set of searchable land features, including landmarks, streets, addresses and Points of Interest, you must load your own high-detail custom map produced with our MapCreate 6 software. For a complete description of what detail is found in the background map and custom MapCreate maps, see page 99.

The unit's varied search functions all begin with either the Find Waypoint menu or the Map Page menu. Press **WPT** and the Find Waypoint menu appears for waypoints and Points of Interest (POI). From the Map Page, press **MENU** and the Map Page menu appears for streets, addresses and highway exits.

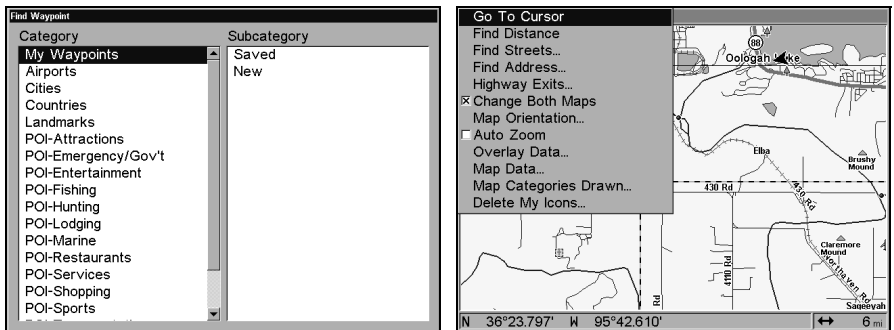

Find Waypoint menu, left and Map Page menu, right.

NOTE:

You can search for items after the unit has acquired a position, or while using it in the "indoor" simulator mode. Distance and bearing to the selected item will be calculated from the unit's current position, or the last known position if operating indoors (without a position determined). You can look up items by name, or search for the item nearest to you.

Find Addresses

1. From the Map Page, press **MENU** | ↓ to **FIND ADDRESS** | **ENT**.
2. Press **ENT** to search in the Address field.

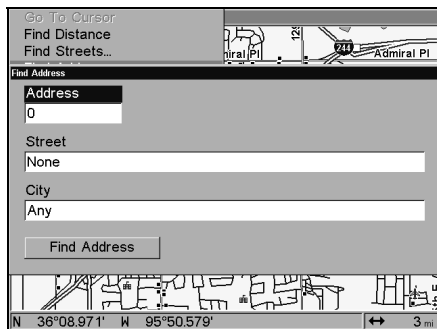

Find Address Menu.

3. To enter an address number, press \uparrow or \downarrow to change the first number, then press \rightarrow to move the cursor to the next number and repeat until the number is correct, then press **ENT**.

4. To enter a street name, press \downarrow to **STREET** | **ENT**. There are two options: **A.** You can **spell out** the name in the top selection box. Press \uparrow or \downarrow to change the first letter, then press \rightarrow to move the cursor to the next letter and repeat until the name is correct, then press **ENT** | **ENT**. **B.** Jump down to the lower selection list by pressing **ENT**, then press \downarrow or \uparrow to select a street name from the list, then press **ENT**. The street name you selected is now in the street field.

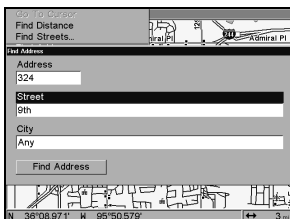
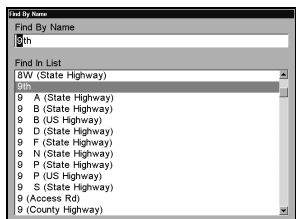
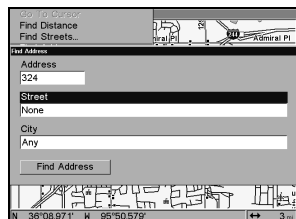

Find Address menu, left; Find Street menu, center, with Find By Name field active; street name entry complete, right.

5. To enter a city name, press \downarrow to **CITY** | **ENT**. You will be asked if you want to find addresses only within a particular city. This option is designed so you can limit an address search to a single city if necessary (see the note below.)

If you select yes, there are two options: **A.** You can **spell out** the city name in the top selection box. Press \uparrow or \downarrow to change the first letter, then press \rightarrow to move the cursor to the next letter and repeat until the name is correct, then press **ENT** | **ENT**. **B.** Jump down to the lower selection list by pressing **ENT**, then press \downarrow or \uparrow to select a city name from the list, then press **ENT**. The city name you selected is now in the city field.

NOTE:

We recommend that you do *not* enter a city name unless the list you are given is too large when searching without it. The unit can actually search quicker without a city and you save time by not entering a city name.

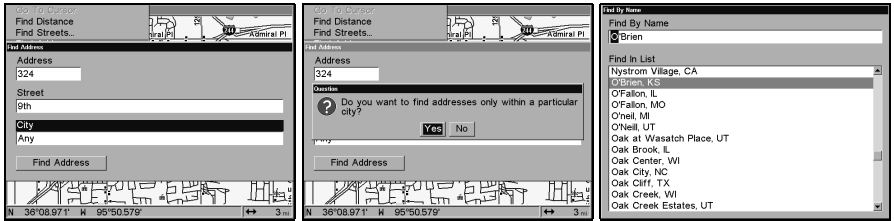

Find city field, left, Search in particular city only option, center; Find City by name, right.

6. When the necessary search fields are filled in, press **↓** to **FIND ADDRESS** | **ENT**. Your unit asks you to wait while it searches for the address. (If an address is not in the database, a message appears saying the address could not be found.)

7. The unit will display a list of addresses. If the address you are looking for is highlighted at the top of the list, press **ENT**. If not, use **↓** and **↑** to select the correct address from the list, then press **ENT**. The Map Page will then appear with the location selected by the cursor. (In the example below, we are looking for 12303 East 11th Street in Tulsa, not 11th Court, so we had to scroll down the list to select the right one.)

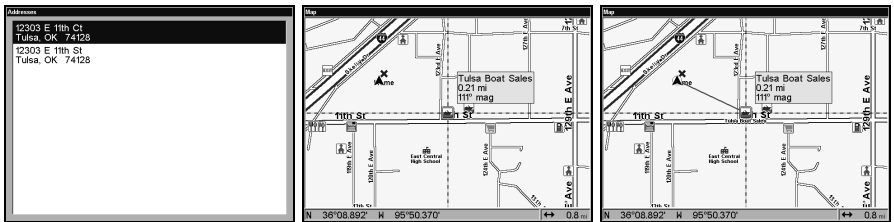

Address search result list, left. At center, Map Page showing location of the address on the map, highlighted by cursor. At right, after the address is located, you can navigate to it.

8. To navigate to the address, press **MENU** | **ENT** | **EXIT** and your unit will begin showing navigation information to the address pointed out by the cursor. If you are only looking up an address (not navigating), just press **EXIT** to return to the previous page.

Tip:

If the address also happens to be an item in the Point of Interest database, you can look up the item's phone number in the Waypoint Information list. With the address location selected by the cursor on the map, press **WPT**. The POI's Waypoint Information window appears, with the Go To Waypoint command highlighted. If you want to go ahead and navigate to the POI address, just press **ENT | EXIT**.

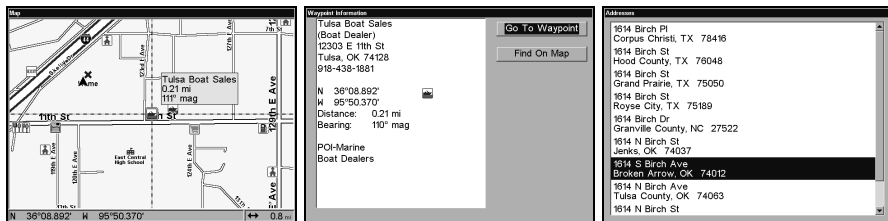

Left, Map Page showing location of the address on the map, highlighted by cursor. Center, this address is a business in the POI database, so you can display the POI information window, then navigate to it. At right, this address is not in the POI database, so the Waypoint key will not display any information for this address.

Find Any Item Selected by Map Cursor

On the Map Page: with a POI or map feature selected by the cursor press **WPT**. To return to the previous page, press **EXIT**.

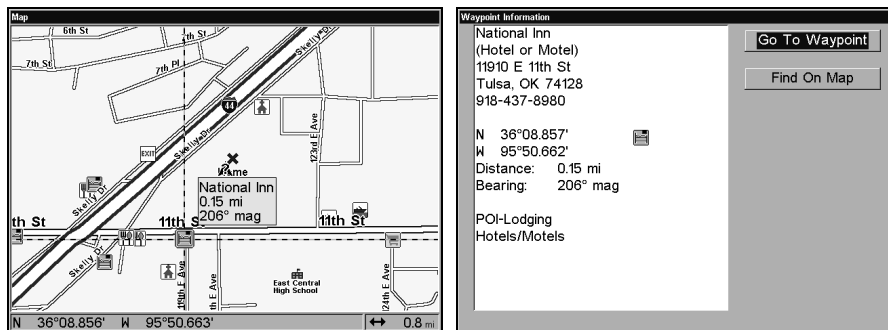

A POI selected by the cursor, left, POI information screen, right.

NOTE:

Since the Go To Waypoint command is highlighted, you can navigate to the selected POI by pressing **ENT | EXIT** while in the POI Waypoint Information screen.

Find Interstate Highway Exits

1. From the Map Page, press **MENU** | ↓ to **HIGHWAY EXITS** | **ENT**, which calls up the Find Exit menu.

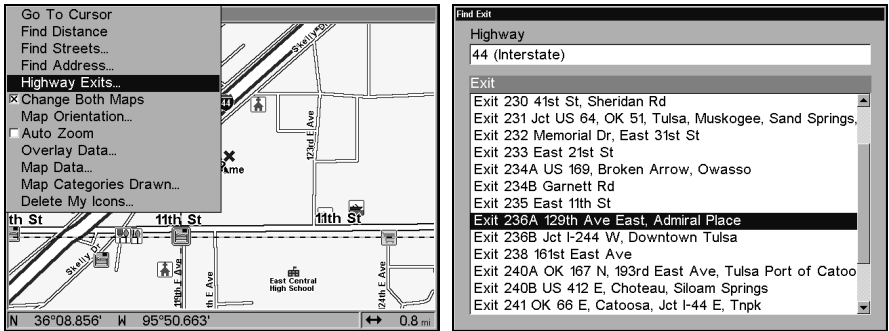

Find Highway Exits command, left, and Find Exit menu, right.

2. First, select a highway name by pressing **ENT**, which calls up the Find By Name menu. There are two highway search options: **A**. You can **spell out** the highway name in the top selection box. Press ↑ or ↓ to change the first letter, then press → to move the cursor to the next letter and repeat until the name is correct, then press **ENT** | **ENT**. **B**. Jump down to the lower selection list by pressing **ENT**, then press ↓ or ↑ to select a highway from the list, then press **ENT**.

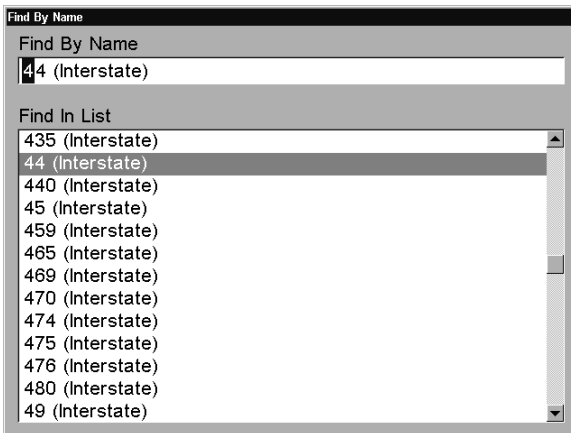

Find By Name menu.

3. Once you have selected a highway name you can then select an exit. Press ↓ to switch to the Exit List, then press ↓ or ↑ until you highlight the exit, then press **ENT**.

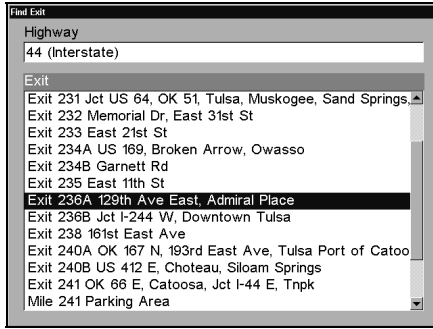

Find Exit menu, with an exit selected in the Exit List.

4. In the Exit Information screen you have two choices. **A.** Press **ENT** to navigate or "go to" the exit. **B.** Press **→** | **ENT** to find the exit on the map.

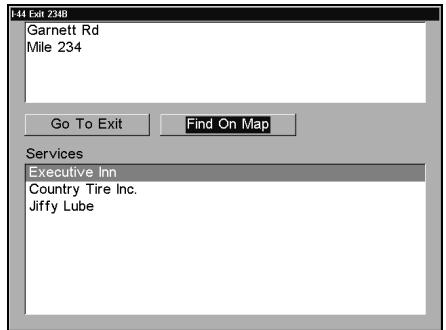
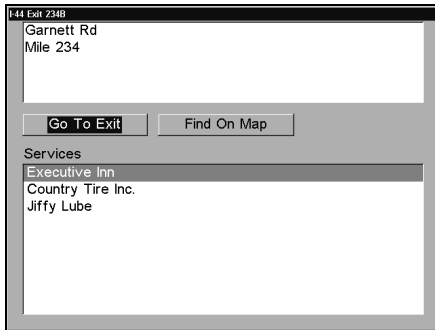

"Go To Exit" option, left, "Find On Map" option, right.

Tip:

You can also look up some additional information on the Exit Services located near this exit. Press **↓** to **SERVICES** | press **↓** or **↑** to select *Service Name* | **ENT**.

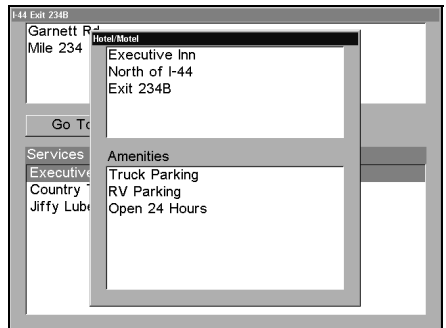
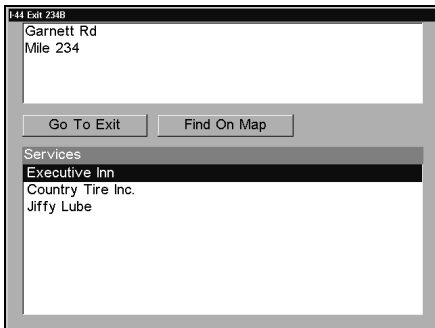

Exit Information screen, left; general location and amenities information, at right.

Find Map Places or Points of Interest (POI)

1. Press **WPT**, press ↓ or ↑ to select a map place or POI category, then press **ENT**. (To narrow your search, press → then press ↓ or ↑ to select a subcategory before pressing **ENT**.) You will be given two options; Search By Name or By Nearest.

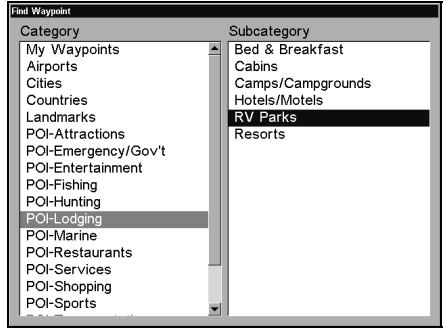
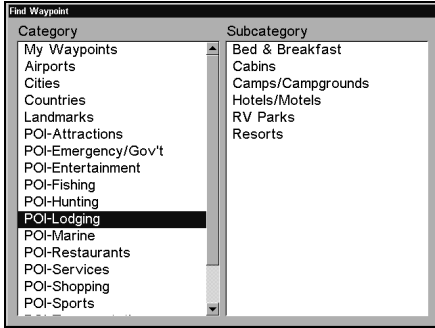

Find Waypoint menu with Lodging POI category selected, left, and with the RV Parks subcategory selected, right.

2. **Search by nearest POI.** Press ↓|**ENT**. The "Find by Nearest" menu will show a "calculating" screen, then a list of the nearest POI's will appear. Press ↓ or ↑ to the selected POI and press **ENT** to call up the POI's Waypoint Information screen.

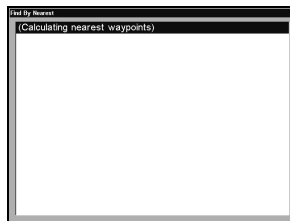
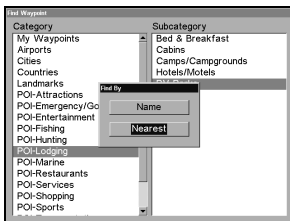

Name	Distance	Bearing
Town & Country Mobile Home Vg	24.55	221°
Branson Stagecoach Rv Park	144.0	73°
Branson Shenangans Rv Park	145.9	71°
Treasure Lake Rv Resort Camp	149.5	71°
Turkey Creek Rv Village	149.8	72°
Parkers Rv Park	150.8	82°
Autumn Run Mobile Home Park	153.1	82°
Justimore Inc	155.7	71°
Wall Eye Haven Mobile Home Pk	157.4	71°
Cedar Haven Rv Mobile Home Pk	173.7	74°
Double J Bar S	175.2	71°
Crossroads Mobile Home Park	176.8	190°
Sunshine Farm Rv Park	181.6	195°
Classic Rv Park	182.9	78°
Barge Point Rv Park	222.2	178°
Paradise Rv Park	224.9	197°

Find by Nearest option, left, Calculating screen, center, POI list, right.

3. **Search by name of POI.** Press **ENT**. There are two options: **A.** You can **spell out** the POI in the top selection box. Press ↑ or ↓ to change the first letter, then press → to move the cursor to the next letter and repeat until the name is correct, then press **ENT|ENT**. **B.** Jump down to the lower selection list by pressing **ENT**, then press ↓ or ↑ to select a POI from the list, then press **ENT** to call up the POI's Waypoint Information screen.

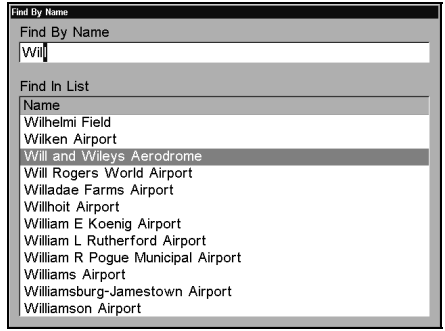
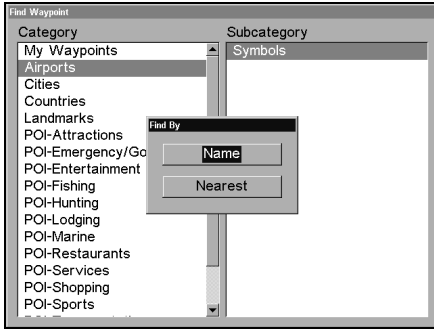

Find by Name option, left, Find by Name menu, right.

4. When the POI's Waypoint Information screen is displayed, you can choose to "Go To" the POI waypoint by pressing **ENT** or find it on the map by pressing →|**ENT**.

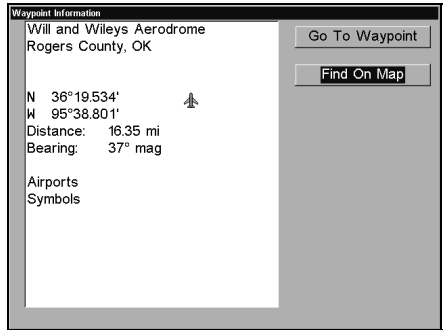
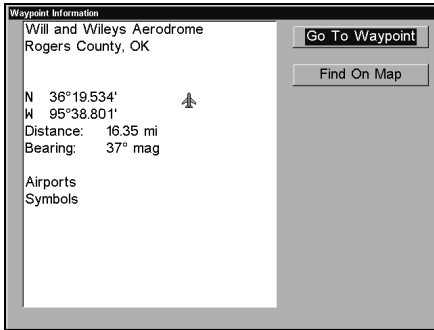

Go To Waypoint POI option, left; Find on Map POI option, right.

Find Streets or Intersections

Find a Street

1. From the Map Page, press **MENU** | ↓ to **FIND STREETS** | **ENT** and the Find Streets Menu appears.

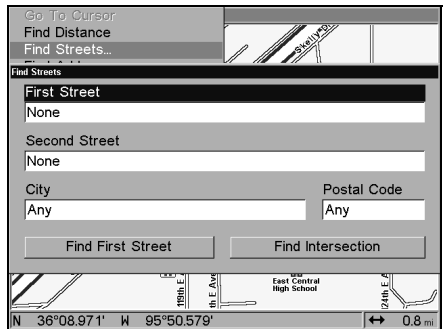
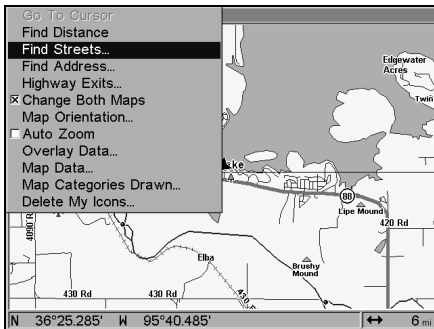

Find Streets command, left, Find Streets menu, right.

2. You must first fill in a street name in the First Street dialog box. Press **ENT** to display the Find By Name menu. There are two options: **A**. You can **spell out** the street in the top selection box. Press **↑** or **↓** to change the first letter, then press **→** to move the cursor to the next letter and repeat until the name is correct, then press **ENT|ENT**. **B**. Or you can jump down to the lower box and pick a street from the **selection list**. Press **ENT**, then press **↓** or **↑** to select a street from the list and press **ENT**.

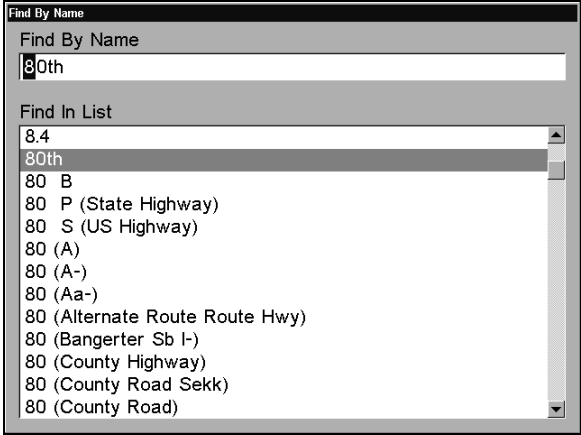

Find Street By Name menu. Spell out name in the top box, or select from the list in the lower box.

3. The Find Streets menu reappears with the street you're searching for in the First Street box. (In this example, it's 80th Street.) To search for that street, press **↓** to **FIND FIRST STREET|ENT**. A message appears asking you to wait while the unit finds the street. When the Streets Found list appears, press **↑** or **↓** to select the street you are searching for and press **ENT**.

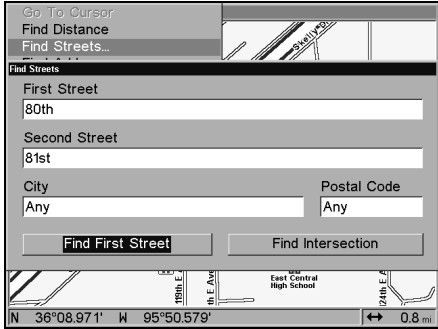

At left, the Find Streets menu with the Find First Street command highlighted. At right, Streets Found list.

4. The Map Page appears, with the cursor pointing to the found street.

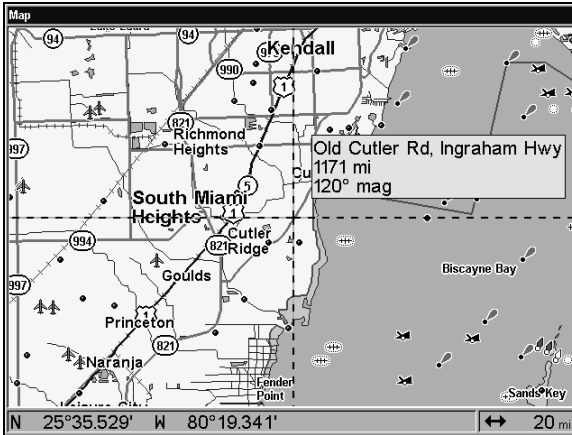

**Map Page showing results of a street search.
The cursor points to the located street.**

If you want to navigate to the found street at the cursor location, just press **MENU | ENT | EXIT**.

Find an Intersection

You must enter one street in the First Street dialog box and enter the next street in the Second Street dialog box.

1. From the Map Page, press **MENU | ↓** to **FIND STREETS | ENT** and the Find Streets Menu appears.
2. You must fill in a street name in the First Street dialog box. Press **ENT** to display the Find By Name menu. There are two options: **A.** You can **spell out** the street in the top selection box. Press **↑** or **↓** to change the first letter, then press **→** to move the cursor to the next letter and repeat until the name is correct, then press **ENT | ENT**. **B.** Or you can jump down to the lower box and pick a street from the **selection list**. Press **ENT**, then press **↓** or **↑** to select a street from the list and press **ENT**.
3. The Find Streets menu reappears with the street you're searching for in the First Street box. (In this example, it's 80th Street.)
4. Now fill in the second street. Press **↓** to **SECOND STREET | ENT** and the Find By Name menu appears again. Just like before, there are two options: **A.** You can **spell out** the second street in the top selection box. Press **↑** or **↓** to change the first letter, then press **→** to move the cursor to the next letter and repeat until the name is correct, then press **ENT | ENT**. **B.** Or you can jump down to the lower box and pick the second street from the **selection list**. Press **ENT**, then press **↓** or **↑** to select a street from the list and press **ENT**.

5. The Find Streets menu reappears with the first and second street dialog boxes filled in. In this example, we selected 71st Street as our second street. You could now use similar techniques to select a city or Zip code, but your search will probably be faster if you leave those boxes blank. (You can specify a city and/or Zip code later on to narrow the search, if the resulting list is too long.)

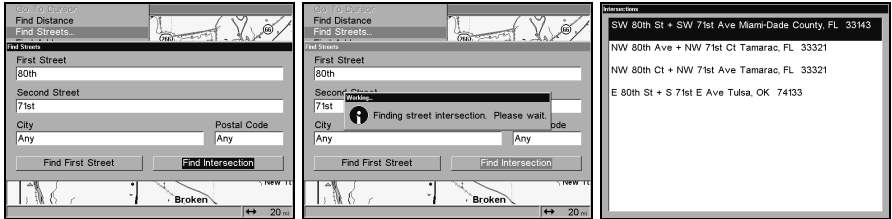

Find Intersection command highlighted, left, and "Working" message, center. At right is the Intersections Found list.

6. To search for the intersection of the two streets, press ↓ to **FIND INTERSECTION | ENT**. A message appears asking you to wait while the unit finds the intersection. When the Intersections Found list appears, press ↑ or ↓ to select the intersection you are searching for and press **ENT**. (In the example on the previous page, we selected the intersection of SW 80th Street and SW 71st Avenue in Miami, Fla.)

7. The Map Page appears, with the cursor pointing to the found intersection. The intersection in our example is shown below.

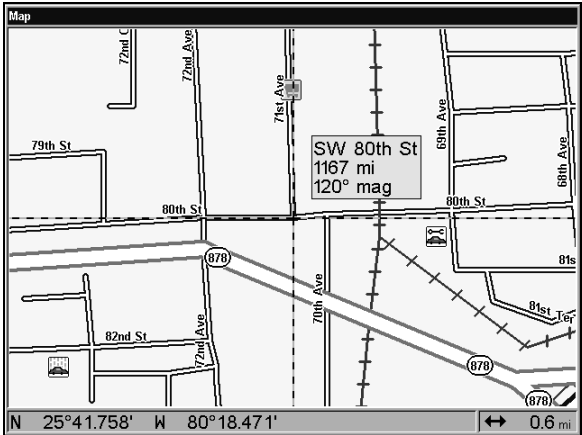

Map Page showing results of an intersection search. The cursor points to the located intersection.

If you want to navigate to the found intersection, just press **MENU | ENT | EXIT**.

Find Waypoints

1. Press **WPT** | **ENT**.

2. If searching for the waypoint *By Name*, press **ENT**. If searching for the *Nearest* waypoint, press **↓** to **NEAREST**|**ENT**. (To search by name, jump to step 5 below.)

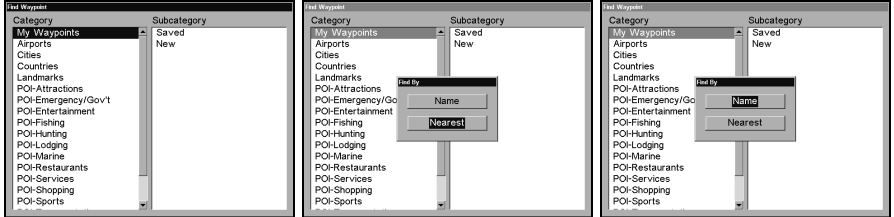

Find Waypoint menu, left; Find By Nearest command, center, Find by Name command, right.

3. If you're looking for nearest, the unit says it is calculating, then a list of waypoints appears. The closest is highlighted at the top of the list and the farthest at the bottom of the list.

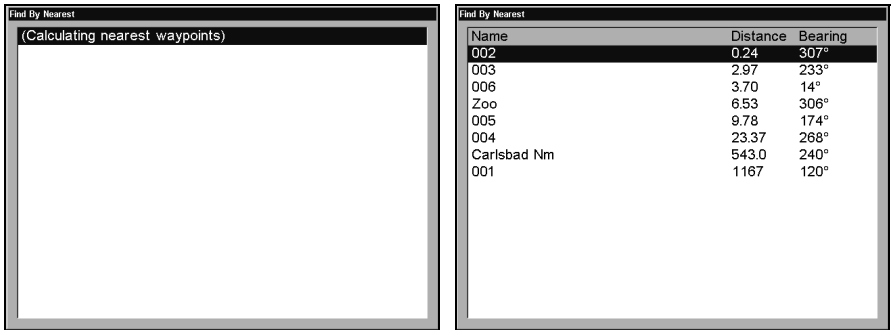

Calculating message, left, and list of the nearest waypoints, right.

4. To see location information on the closest (highlighted) waypoint, press **ENT** and the Waypoint Information screen appears. (If you wanted to, you could select another waypoint from the list with the **↑** or **↓** keys.)

A. *To navigate* to the waypoint, press **ENT**. (The Go To Waypoint command is already highlighted.) The unit will show navigation information to the waypoint.

B. *To find* the waypoint, press **↓** to **FIND ON MAP** | **ENT**. The Map Page appears with the cursor highlighting the found waypoint.

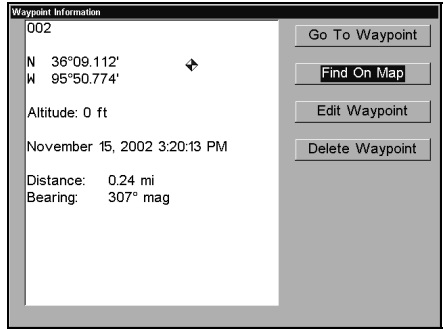
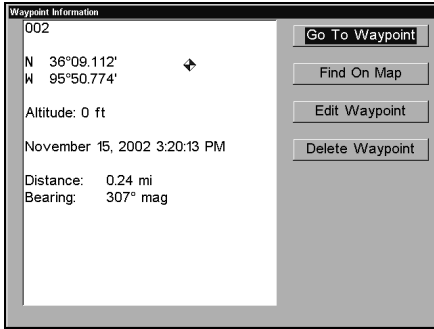

Waypoint Information screens with the Go To Waypoint command selected, left, and the Find on Map command selected, right.

To clear these menus and return to the previous page, press **EXIT** repeatedly.

5. **If you're looking by name**, there are two options: **A.** You can **spell out** the name in the top selection box. Press **↑** or **↓** to change the first letter, then press **→** to move the cursor to the next letter and repeat until the name is correct, then press **ENT|ENT**. **B.** Or you can jump down to the lower selection list by pressing **ENT**, then press **↓** or **↑** to select a waypoint from the list, then press **ENT**. The waypoint information screen appears.

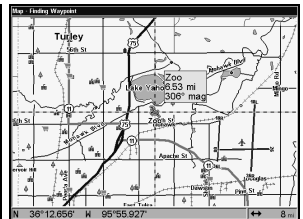
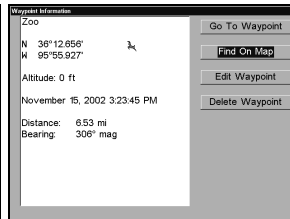
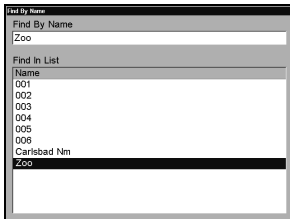

Find By Name menu, left. Waypoint Information screen, center. At right, the found waypoint is highlighted by the cursor on the Map Page.

A. To navigate to the waypoint, press **ENT**. (Go To Waypoint command is already highlighted.) The unit will show navigation information to the waypoint.

B. To find the waypoint, press **↓** to **FIND|ENT**. The Map Page appears with the cursor highlighting the found waypoint.

To clear these menus and return to the previous page, press **EXIT** repeatedly.

Notes

Section 10: Supplemental Material

Datums Used by This Unit

WGS 1984 Default	Arc 1950 - Botswana	Bermuda 1957 - Bermuda
Adindan Mean for Ethiopia, Sudan	Arc 1950 - Burundi	Bissau - Guinea-Bissau
Adindan Burkina Faso	Arc 1950 - Lesotho	Bogota Observatory - Colombia
Adindan Cameroon	Arc 1950 - Malawi	Bukit Rimpah - Indonesia (Bangka & Belitung Islands)
Adindan Ethiopia	Arc 1950 - Swaziland	Camp Area Astro - Antarctica (McMurdo Camp Area)
Adindan Mali	Arc 1950 - Zaire	Campo Inchauspe - Argentina
Adindan Senegal	Arc 1950 - Zambia	Canton Astro 1966 - Phoenix Islands
Adindan Sudan	Arc 1950 - Zimbabwe	Cape - South Africa
Afgooye Somalia	Arc 1960 - Mean for Kenya, Tanzania	Cape Canaveral - Bahamas, Florida
Ain el Abd 1970 Bahrain	Ascension Island 1958 - Ascension Island	Carthage - Tunisia
Ain el Abd 1970 Saudi Arabia	Astro Beacon E 1945 - Iwo Jima	Switzerland
Anna 1 Astro 1965 Cocos Islands	Astro DOS 71/4 - St. Helena Island	Chatham Island Astro 1971; New Zealand (Chatham Island)
Antigua Island Astro 1943; Antigua (Leeward Islands)	Astro Tern Island (FRIG) 1961 - Tern Island	Chua Astro Paraguay
Arc 1950; Mean for Botswana, Lesotho, Malawi, Swaziland, Zaire, Zambia and Zimbabwe	Astronomical Station 1952 - Marcus Island	Corrego Alegre Brazil
	Australian Geodetic 1966 - Australia & Tasmania	Dabola Guinea
	Australian Geodetic 1984 - Australia & Tasmania	Djakarta (Batavia) Indonesia (Sumatra)
	Ayabelle Lighthouse - Djibouti	
	Bellevue (IGN) - Efate & Erromango Islands	

DOS 1968 New Georgia Islands (Gizo Island)	European 1950 Italy (Sardinia)	Mahe Island
Easter Island 1967 Easter Island	European 1950 (Sicily) European 1950 Malta	Massawa Ethiopia (Eritrea) Merchich Morocco
European 1950 Mean for Austria, Belgium, Denmark, Finland, France, West Germany, Gibraltar, Greece, Italy, Luxembourg, Netherlands, Norway, Portugal, Spain, Sweden, Switzerland	Ireland 1965 Ireland ISTS 061 Astro 1968 South Georgia Islands ISTS 073 Astro 1969 Diego Garcia	Midway Astro 1961 Midway Islands Minna Cameroon Minna Nigeria
European 1950 Mean for Austria, Denmark, France, West Germany, Netherlands, Switzerland	Johnston Island 1961 Johnston Island Kandawala Sri Lanka	Montserrat Island Astro 1958; Montserrat (Leeward Islands) M'Poraloko Gabon, Nahrwan, Oman (Masirah Island)
European 1950 Mean for Iraq, Israel, Jordan, Lebanon, Kuwait, Saudi Arabia, Syria	Kerguelen Island 1949 Kerguelen Island Kertau 1948 West Malaysia & Singapore	Nahrwan Saudi Arabia Nahrwan United Arab Emirates
European 1950 Cyprus	Kusaie Astro 1951 Caroline Islands	Naparima BWI Trinidad & Tobago
European 1950 Egypt	L.C. 5 Astro 1961 Cayman Brac Island	North American 1927 Mean for Antigua, Barbados, Barbuda, Caicos Islands, Cuba, Dominican Republic, Grand Cayman, Jamaica, Turks Islands
European 1950 England, Channel Islands, Ireland, Scotland, Shetland Islands	Leigon Ghana Liberia 1964 Liberia	
European 1950 Finland, Norway	Luzon Philippines (Excluding Mindanao)	North American 1927 Mean for Belize, Costa Rica, El Salvador, Guatemala, Honduras, Nicaragua
European 1950 Greece	Luzon Philippines (Mindanao)	
European 1950 Iran	Mahe 1971	North American 1927 Mean for Canada

North American 1927 Mean for CONUS (Continental United States)	North American 1927 Cuba	Great Britain 1936 - England
North American 1927 Mean for CONUS (East of Mississippi River) including Louisiana, Missouri, Minnesota	North American 1927 Greenland (Hayes Peninsula)	Ordinance Survey Great Britain 1936 - England, Isle of Man, Wales
North American 1927 Mean for CONUS (West of Mississippi River)	North American 1927 Mexico	Ordinance Survey Great Britain 1936 - Scotland, Shetland Islands
North American 1927 Alaska	North American 1983 Alaska, Canada, CONUS	Ordinance Survey Great Britain 1936 - Wales
North American 1927 Bahamas (Except San Salvador Island)	North American 1983 Central America, Mexico	Pico de las Nieves Canary Islands
North American 1927 Bahamas (San Salvador Island)	Observatorio Metereo 1939; Azores (Corvo & Flores Islands)	Pitcairn Astro 1967 Pitcairn Island
North American 1927 Canada (Alberta, British Columbia)	Old Egyptian 1907 Egypt	Point 58
North American 1927 Canada (Manitoba, Ontario)	Old Hawaiian Mean for Hawaii, Kauai, Maui, Oahu	Sweden
North American 1927 Canada (New Brunswick, Newfoundland, Nova Scotia, Quebec)	Old Hawaiian Hawaii	Santo (DOS) 1965 Espirito Santo Island
North American 1927 Canada (Northwest Territories, Saskatchewan)	Old Hawaiian Kauai	Sao Braz Azores (Sao Miguel, Santa Maria Islands)
North American 1927 Canada (Yukon)	Old Hawaiian Maui	Sapper Hill 1943 East Falkland Island
North American 1927 Canal Zone	Old Hawaiian Oahu	Schwarzeck Nambia
	Oman Oman	Selvagem Grande Salvage Islands
	Ordinance Survey Great Britain 1936 - Mean for England, Isle of Man, Scotland, Shetland Islands, Wales	SGS 85 Soviet Geodetic System 1985
	Ordinance Survey	South American 1969 Mean for Argentina,

Bolivia, Brazil, Chile, Colombia, Ecuador, Guyana, Paraguay, Peru, Trinidad & Tobago, and Venezuela	South American 1969 Paraguay South American 1969 Peru	Tokyo Korea Tokyo Okinawa
South American 1969 Argentina	South American 1969 Trinidad & Tobago	Tristan Astro 1968 Tristan da Cunha
South American 1969 Bolivia	South American 1969 Venezuela	Viti Levu 1916 Fiji (Viti Levu Island)
South American 1969 Brazil	South Asia Singapore	Wake Eniwetok 1960
South American 1969 Chile	Tananarive Observatory 1925; Madagascar	Marshall Islands
South American 1969 Colombia	Timbalai 1948 Brunei, East Malaysia (Sabah, Sarawak)	Wake Island Astro 1952 Wake Atoll
South American 1969 Ecuador	Tokyo Mean for Japan, Korea, Okinawa	WGS 1972 Global Definition
South American 1969 Ecuador (Baltra, Galapagos)	Tokyo Japan	Yacare Uruguay
South American 1969 Guyana		Zanderij Suriname

FCC Compliance

This device complies with Part 15 of the U.S. Federal Communications Commission (FCC) Rules. Operation is subject to the following two conditions: (1) this device may not cause harmful interference, and (2) this device must accept any interference received, including interference that may cause undesired operation.

Changes or modifications not expressly approved by the manufacturer could void the user's authority to operate the equipment.

Note:

This equipment has been tested and found to comply with the limits for a Class B digital device, pursuant to Part 15 of the FCC Rules. These limits are designed to provide reasonable protection against harmful interference in a residential installation. This equipment generates, uses and can radiate radio frequency energy and, if not installed and used in accordance with the instructions, may cause harmful interference to radio communications. However, there is no guarantee that interference will not occur in a particular installation. If this equipment does cause harmful interference to radio or television reception, which can be determined by turning the equipment off and on, the user is encouraged to try to correct the interference by one or more of the following measures:

- Reorient or relocate the receiving antenna.
- Increase the separation between the equipment and receiver.
- Connect the equipment into an outlet on a circuit different from that to which the receiver is connected.
- Consult the factory customer service department for help.

Notes

LOWRANCE DATABASES LICENSE AGREEMENT

THIS IS A LEGAL AGREEMENT BETWEEN THE END-USER WHO FIRST PURCHASES THIS PRODUCT AS A CONSUMER ITEM FOR PERSONAL, FAMILY, OR HOUSEHOLD USE ("YOU") AND LOWRANCE ELECTRONICS, INC., THE MANUFACTURER OF THIS PRODUCT ("WE", "OUR", OR "US"). USING THE PRODUCT ACCOMPANIED BY THIS LICENSE AGREEMENT CONSTITUTES ACCEPTANCE OF THESE TERMS AND CONDITIONS. IF YOU DO NOT ACCEPT ALL TERMS AND CONDITIONS, PROMPTLY RETURN THE PRODUCT WITHIN 30 DAYS OF PURCHASE. PLEASE RETURN USING THE ENCLOSED UPS SHIPPING LABEL AND INCLUDE: PROOF OF PURCHASE, NAME, ADDRESS, AND PHONE NUMBER. YOUR PURCHASE PRICE AND ANY APPLICABLE TAXES WILL BE REFUNDED. PLEASE ALLOW 4-6 WEEKS TO PROCESS YOUR REFUND.

1. This License Agreement applies to the one or more databases that your product may contain. We refer to these singly as a "Database" and together as the "Databases." Your product may thus include the "WBS Database" which contains worldwide background surface mapping data, the "SmartMap Database" which contains inland mapping data, or other Databases.
2. The Databases that your product may contain are licensed, not sold. We grant to you the nonexclusive, nonassignable right to use these Databases for supplemental navigation reference purposes, but only as long as you comply with the terms and conditions of this License Agreement. We reserve the right to terminate this license if you violate any aspect of this License Agreement. You are responsible for using official government charts and prudent navigation for safe travel.
3. The Databases housed in your product are protected by the copyright notices appearing on the product or its screen(s). You may NOT modify, adapt, translate, reverse engineer, decompile, disassemble, rent, lease, or resell any Database, and you may NOT create derivative works based upon any Database or its contents. Any unauthorized reproduction, use, or transfer of a Database may be a crime and may subject you to damages and attorney fees.
4. This License Agreement will terminate immediately without prior notice from us if you fail to comply with or violate any of the provisions of this Agreement. Upon termination, you will promptly return all products containing one or more Databases to us.
5. Prices and programs are subject to change without notice.
6. This License Agreement shall be governed by the laws of the State of Oklahoma and comprises the complete and exclusive understanding between you and us concerning the above subject matter.

DATABASES LIMITED WARRANTY

"We", "our", or "us" refers to Lowrance Electronics, Inc., the manufacturer of this product. "You" or "your" refers to the first person who purchases the product as a consumer item for personal, family, or household use. The Databases Limited Warranty applies to the one or more databases that your product may contain. We refer to each of these as a "Database" or together as the "Databases." Your product may thus include the "WBS Database" which contains worldwide background surface mapping data, the "SmartMap Database" which contains inland mapping data, or other Databases.

We warrant to you that we have accurately compiled, processed, and reproduced the portions of the source material on which the Databases are based. However, we are under no obligation to provide updates to the Databases, and the data contained in the Databases may be incomplete when compared to the source material. **WE MAKE NO EXPRESS OR IMPLIED WARRANTY OF ANY KIND ABOUT THE ACCURACY OF THE SOURCE MATERIAL ITSELF, INCLUDING BUT NOT LIMITED TO IMPLIED WARRANTIES OF MERCHANTABILITY OR FITNESS FOR A PARTICULAR PURPOSE.**

If there is a defect in any Database, your exclusive remedy shall be, at our option, either a refund of the price you paid for the product containing the defective Database or a replacement of such product. **WE WILL NOT UNDER ANY CIRCUMSTANCES BE LIABLE TO ANYONE FOR ANY SPECIAL, CONSEQUENTIAL, INCIDENTAL, OR OTHER INDIRECT DAMAGE OF ANY KIND.**

Some states do not allow the exclusion or limitation of incidental or consequential damages, so the above limitations or exclusions may not apply to you.

This warranty does NOT apply in the following circumstances: (1) when the product has been serviced or repaired by anyone other than us; (2) when the product has been connected, installed, combined, altered, adjusted, or handled in a manner other than according to the instructions furnished with the product; (3) when any serial number has been effaced, altered, or removed; or (4) when any defect, problem, loss, or damage has resulted from any accident, misuse, negligence, or carelessness, or from any failure to provide reasonable and necessary maintenance in accordance with the instructions of the owner's manual for the product.

We reserve the right to make changes or improvements in our products from time to time without incurring the obligation to install such improvements or changes on equipment or items previously manufactured.

This warranty gives you specific legal rights and you may also have other rights which may vary from state to state.

Your remedies under this warranty will be available so long as you can show in a reasonable manner that the defect occurred within one (1) year from the date of your original purchase, and we must receive your warranty claim no later than 30 days after such 1-year period expires. Your claim must be substantiated by a dated sales receipt or sales slip.

LOWRANCE ELECTRONICS FULL ONE-YEAR WARRANTY

"We," "our," or "us" refers to LOWRANCE ELECTRONICS, INC., the manufacturer of this product. "You" or "your" refers to the first person who purchases this product as a consumer item for personal, family or household use.

We warrant this product against defects or malfunctions in materials and workmanship, and against failure to conform to this product's written specifications, all for one (1) year from the date of original purchase by you. WE MAKE NO OTHER EXPRESS WARRANTY OR REPRESENTATION OF ANY KIND WHATSOEVER CONCERNING THIS PRODUCT. Your remedies under this warranty will be available so long as you can show in a reasonable manner that any defect or malfunction in materials or workmanship, or any non-conformity with the product's written specifications, occurred within one year from the date of your original purchase, which must be substantiated by a dated sales receipt or sales slip. Any such defect, malfunction, or non-conformity which occurs within one year from your original purchase date will either be repaired without charge or be replaced with a new product identical or reasonably equivalent to this product, at our option, within a reasonable time after our receipt of the product. If such defect, malfunction, or non-conformity remains after a reasonable number of attempts to repair by us, you may elect to obtain without charge a replacement of the product or a refund for the product. THIS REPAIR, OR REPLACEMENT OR REFUND (AS JUST DESCRIBED) IS THE EXCLUSIVE REMEDY AVAILABLE TO YOU AGAINST US FOR ANY DEFECT, MALFUNCTION, OR NON-CONFORMITY CONCERNING THE PRODUCT OR FOR ANY LOSS OR DAMAGE RESULTING FROM ANY OTHER CAUSE WHATSOEVER. WE WILL NOT UNDER ANY CIRCUMSTANCES BE LIABLE TO ANYONE FOR ANY SPECIAL, CONSEQUENTIAL, INCIDENTAL, OR OTHER INDIRECT DAMAGE OF ANY KIND.

Some states do not allow the exclusion or limitation of incidental or consequential damages, so the above limitations or exclusions may not apply to you.

This warranty does NOT apply in the following circumstances: (1) when the product has been serviced or repaired by anyone other than us; (2) when the product has been connected, installed, combined, altered, adjusted, or handled in a manner other than according to the instructions furnished with the product; (3) when any serial number has been effaced, altered, or removed; or (4) when any defect, problem, loss, or damage has resulted from any accident, misuse, negligence, or carelessness, or from any failure to provide reasonable and necessary maintenance in accordance with the instructions of the owner's manual for the product.

We reserve the right to make changes or improvements in our products from time to time without incurring the obligation to install such improvements or changes on equipment or items previously manufactured.

This warranty gives you specific legal rights and you may also have other rights which may vary from state to state.

REMINDER: You must retain the sales slip or sales receipt proving the date of your original purchase in case warranty service is ever required.

**LOWRANCE ELECTRONICS
12000 E. SKELLY DRIVE, TULSA, OK 74128
(800) 324-1356**

How to Obtain Service...

...in the USA:

We back your investment in quality products with quick, expert service and genuine Lowrance parts. If you're in the United States and you have technical, return or repair questions, please contact the Factory Customer Service Department. Before any product can be returned, you must call customer service to determine if a return is necessary. Many times, customer service can resolve your problem over the phone without sending your product to the factory. To call us, use the following toll-free number:

800-324-1356

8 a.m. to 5 p.m. Central Standard Time, M-F

Lowrance Electronics may find it necessary to change or end our shipping policies, regulations, and special offers at any time. We reserve the right to do so without notice.

...in Canada:

If you're in Canada and you have technical, return or repair questions, please contact the Factory Customer Service Department. Before any product can be returned, you must call customer service to determine if a return is necessary. Many times, customer service can resolve your problem over the phone without sending your product to the factory. To call us, use the following toll-free number:

800-661-3983

905-629-1614 (not toll-free)

8 a.m. to 5 p.m. Eastern Standard Time, M-F

...outside Canada and the USA:

If you have technical, return or repair questions, contact the dealer in the country where you purchased your unit. To locate a dealer near you, visit our web site, www.lowrance.com and look for the Dealer Locator.

Accessory Ordering Information for all countries

To order Lowrance accessories such as cables, transducers or MMC cards, please contact:

1) Your local marine dealer or consumer electronics store. Most quality dealers that handle marine electronic equipment or other consumer electronics should be able to assist you with these items.

To locate a Lowrance dealer near you, visit our web site, www.lowrance.com and look for the Dealer Locator. Or, you can consult your telephone directory for listings.

2) U.S. customers: LEI Extras Inc., PO Box 129, Catoosa, OK 74015-0129
Call 1-800-324-0045 or visit our web site www.lei-extras.com.

3) Canadian customers can write:

Lowrance/Eagle Canada, 919 Matheson Blvd. E. Mississauga, Ontario L4W2R7 or fax 905-629-3118.

Shipping Information

If it becomes necessary to send a product for repair or replacement, you must first receive a return authorization number from Customer Service. Products shipped without a return authorization will not be accepted. When shipping, we recommend you do the following:

1. Always use the original shipping container and filler material the product was packed in.

2. Always insure the parcel against damage or loss during shipment. Lowrance does not assume responsibility for goods lost or damaged in transit.

3. For proper testing, include a brief note with the product describing the problem. Be sure to include your name, return shipping address and a daytime telephone number.

Visit our web site:



L[®] LOWRANCE
We Lead, We Find, You Win.[™]

Lowrance Pub. 988-0151-031

Printed in USA 122002

© Copyright 2002
All Rights Reserved
Lowrance Electronics, Inc.